

Memory Management

Learning Outcomes

- Appreciate the need for memory management in operating systems, understand the limits of fixed memory allocation schemes.
- Understand fragmentation in dynamic memory allocation, and understand basic dynamic allocation approaches.
- Understand how program memory addresses relate to physical memory addresses, memory management in base-limit machines, and swapping
- An overview of virtual memory management.

Process

- One or more threads of execution
- Resources required for execution
 - Memory (RAM)
 - Program code (“text”)
 - Data (initialised, uninitialised, stack)
 - Buffers held in the kernel on behalf of the process
 - Others
 - CPU time
 - Files, disk space, printers, etc.

OS Memory Management

- Keeps track of what memory is in use and what memory is free
- Allocates free memory to process when needed
 - And deallocates it when they don't
- Manages the transfer of memory between RAM and disk.

Memory Hierarchy

- Ideally, programmers want memory that is
 - Fast
 - Large
 - Nonvolatile
- Not possible
- Memory management coordinates how memory hierarchy is used.
 - Focus usually on RAM \Leftrightarrow Disk

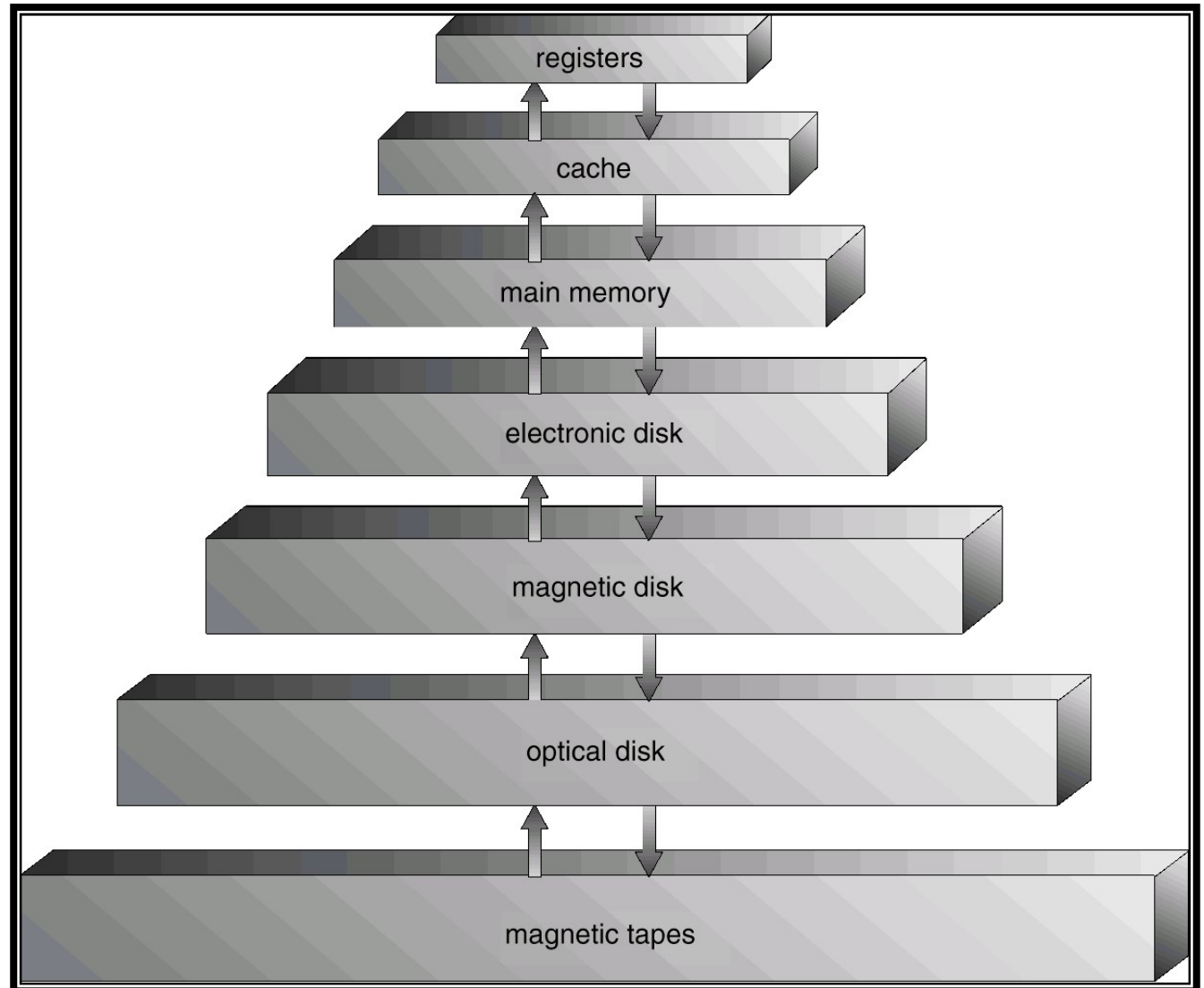

OS Memory Management

- Two broad classes of memory management systems
 - Those that transfer processes to and from external storage during execution.
 - Called swapping or paging
 - Those that don't
 - Simple
 - Might find this scheme in an embedded device, dumb phone, or smartcard.

Basic Memory Management

Monoprogramming without Swapping or Paging

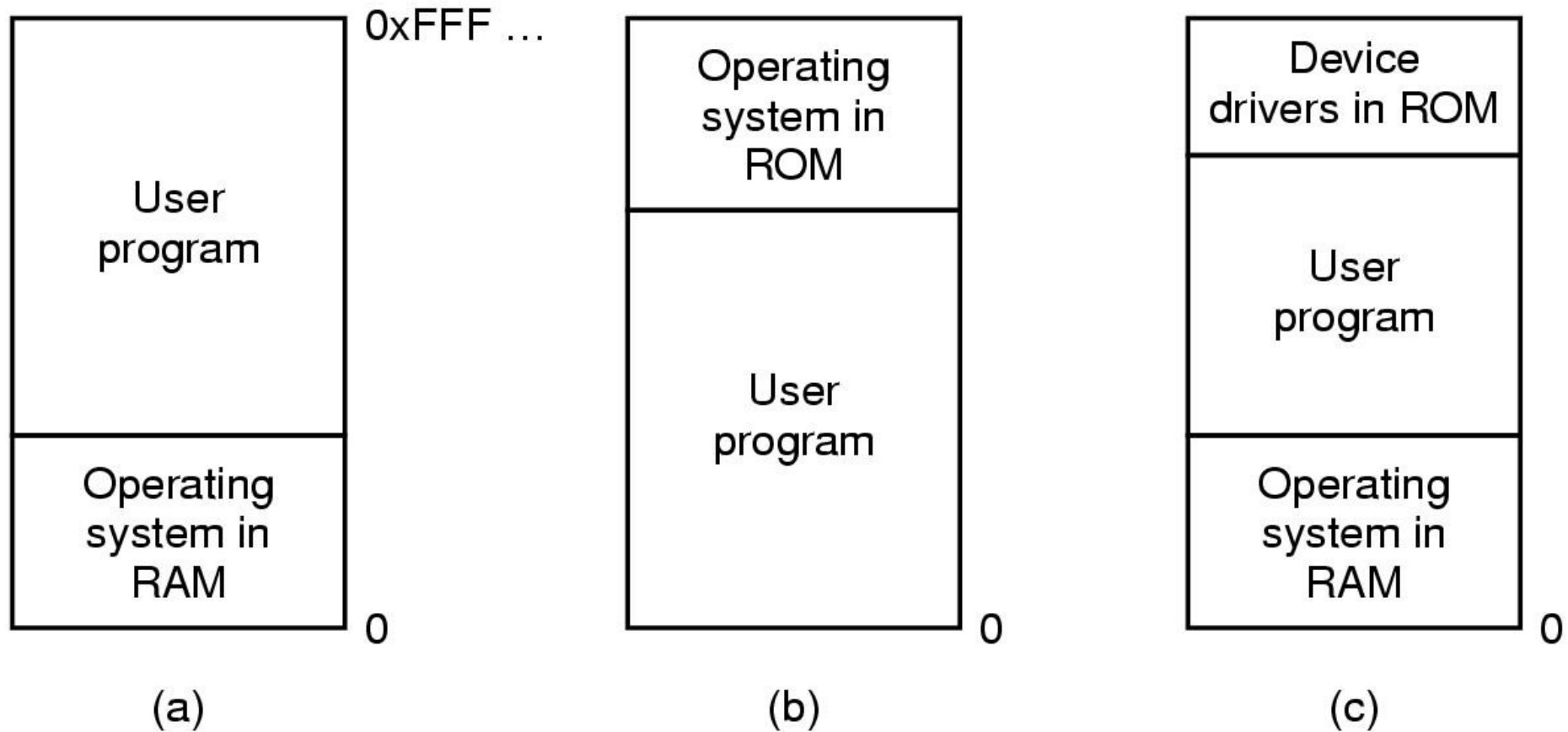

Three simple ways of organizing memory

- an operating system with one user process

Monoprogramming

- Okay if
 - Only have one thing to do
 - Memory available approximately equates to memory required
- Otherwise,
 - Poor CPU utilisation in the presence of I/O waiting
 - Poor memory utilisation with a varied job mix

Idea

- Recall, an OS aims to
 - Maximise memory utilisation
 - Maximise CPU utilization
 - (ignore battery/power-management issues)
- Subdivide memory and run more than one process at once!!!!
 - Multiprogramming, Multitasking

Modeling Multiprogramming

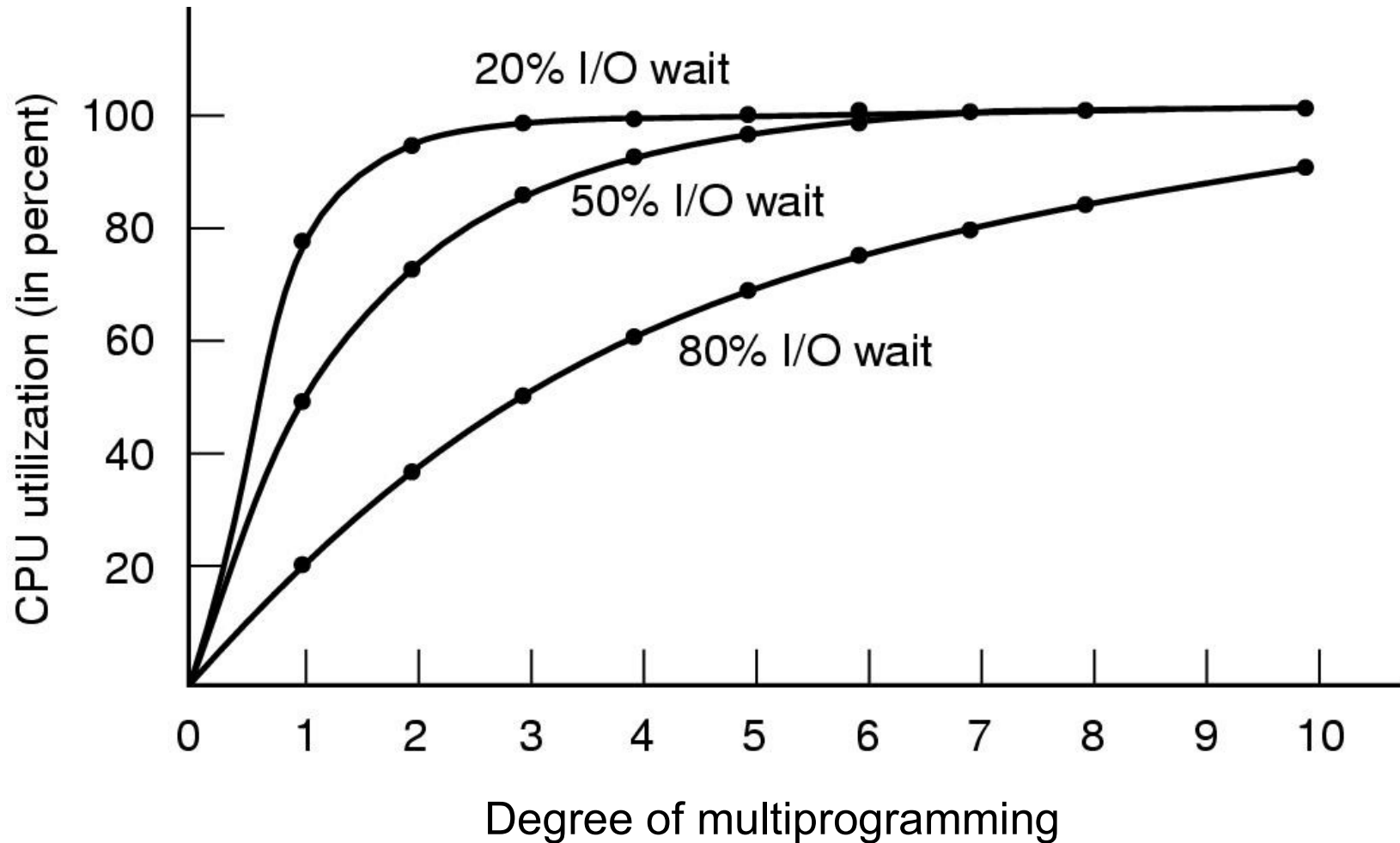

CPU utilization as a function of number of processes in memory

General problem: How to divide memory between processes?

- Given a workload, how to we
 - Keep track of free memory?
 - Locate free memory for a new process?
- Overview of evolution of simple memory management
 - Static (fixed partitioning) approaches
 - Simple, predicable workloads of early computing
 - Dynamic (partitioning) approaches
 - More flexible computing as compute power and complexity increased.
- Introduce virtual memory
 - ~~Segmentation~~ and paging

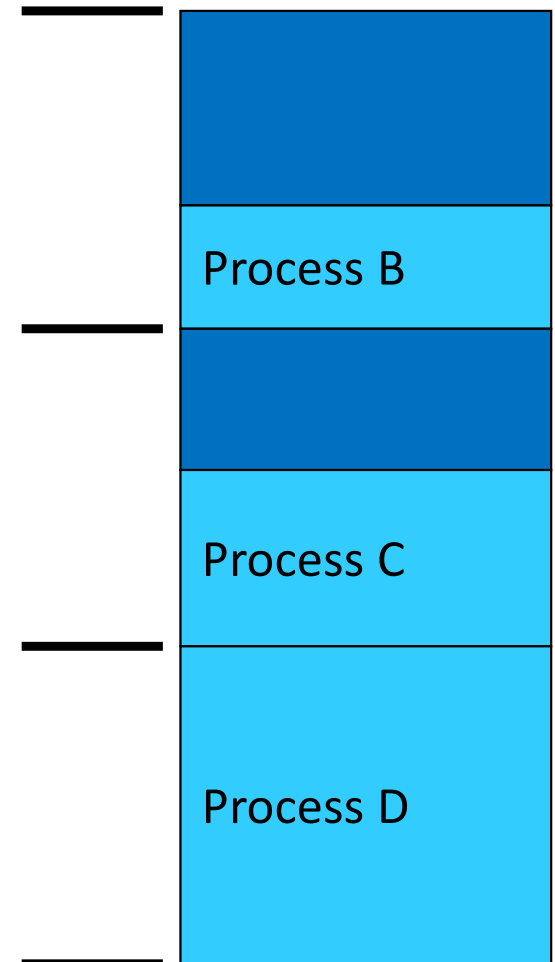

Problem: How to divide memory

- One approach
 - divide memory into fixed equal-sized partitions
 - Any process \leq partition size can be loaded into any partition
 - Partitions are free or busy

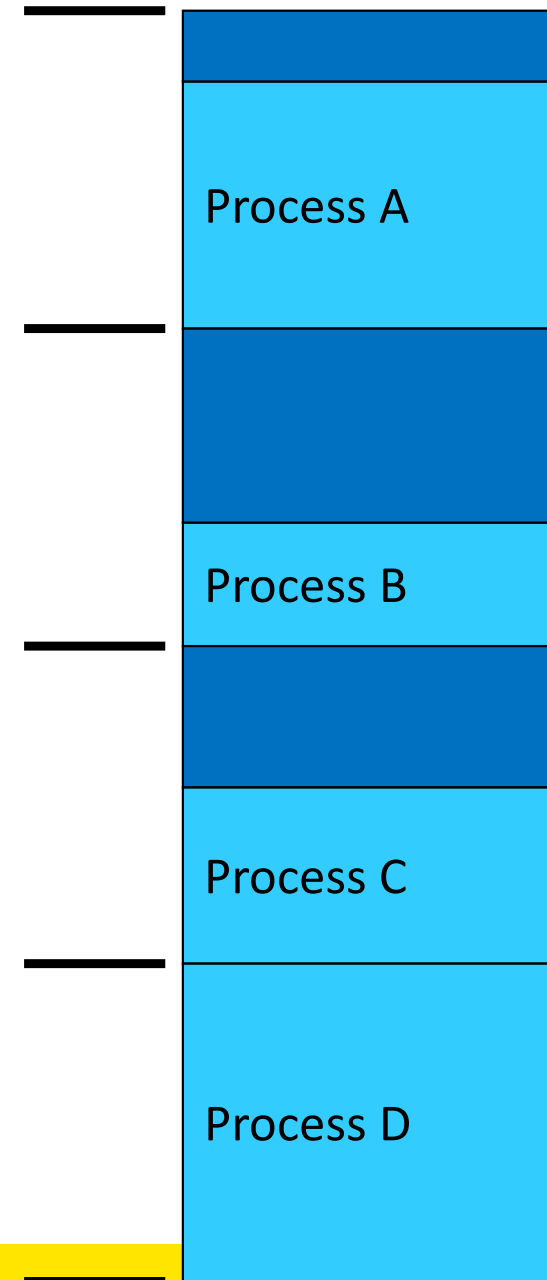

Simple MM: Fixed, equal-sized partitions

- Any unused space in the partition is wasted
 - Called internal fragmentation
- Processes smaller than main memory, but larger than a partition cannot run.

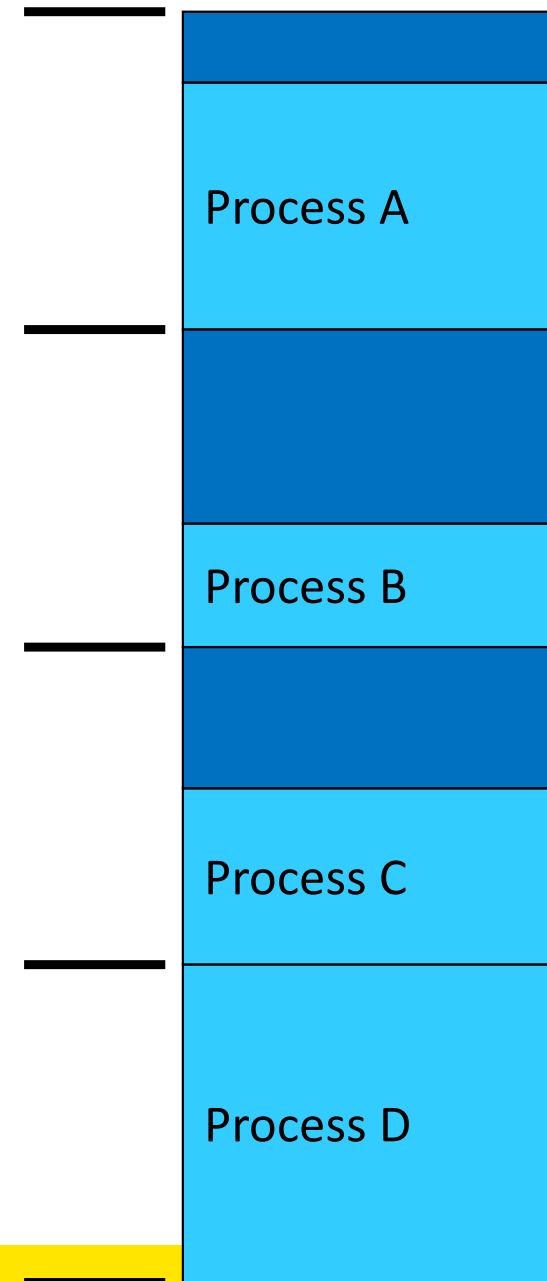

Simple MM: Fixed, variable-sized partitions

- Divide memory at boot time into a selection of different sized partitions
 - Can base sizes on expected workload
- Each partition has queue:
 - Place process in queue for smallest partition that it fits in.
 - Processes wait for when assigned partition is empty to start

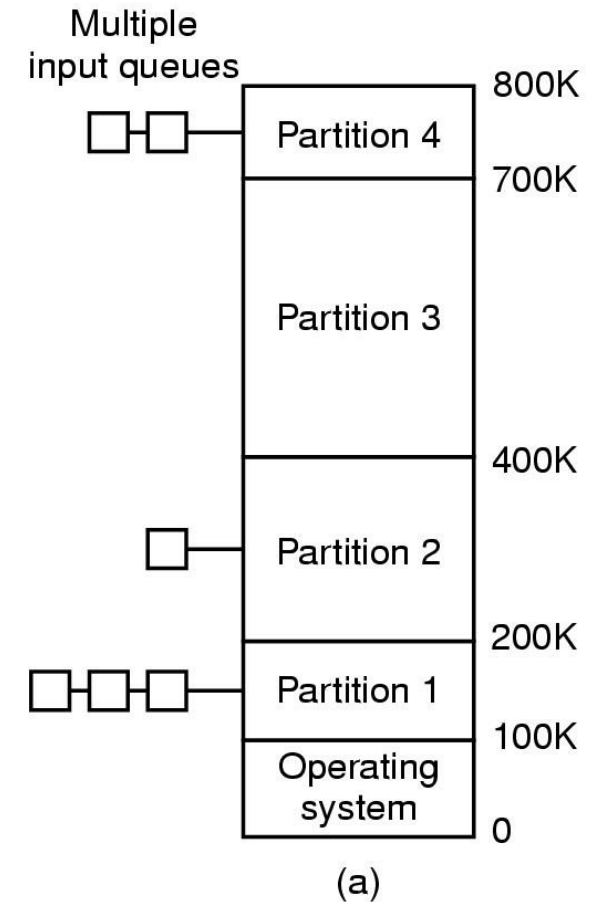

- Issue

- Some partitions may be idle
 - Small jobs available, but only large partition free
 - Workload could be unpredictable

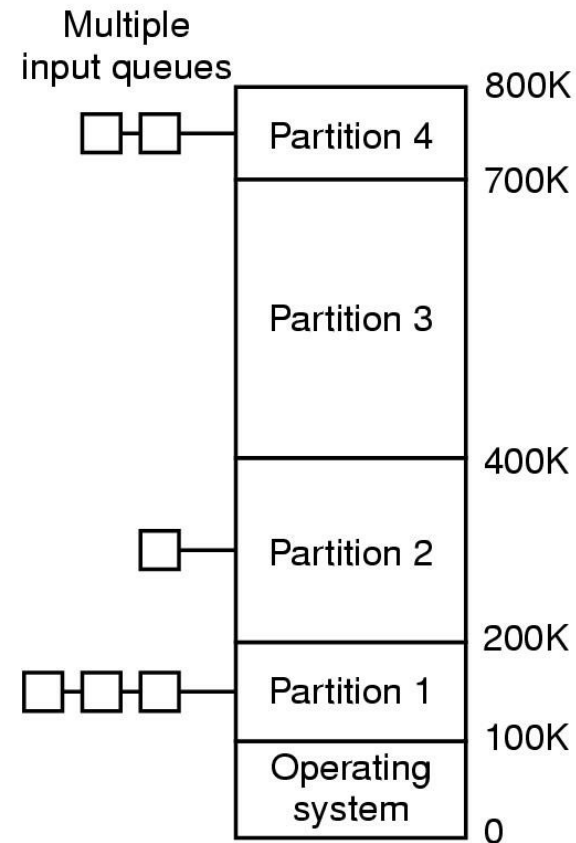

(a)

Alternative queue strategy

- Single queue, search for any jobs that fit
 - Small jobs in large partition if necessary
- Increases internal memory fragmentation

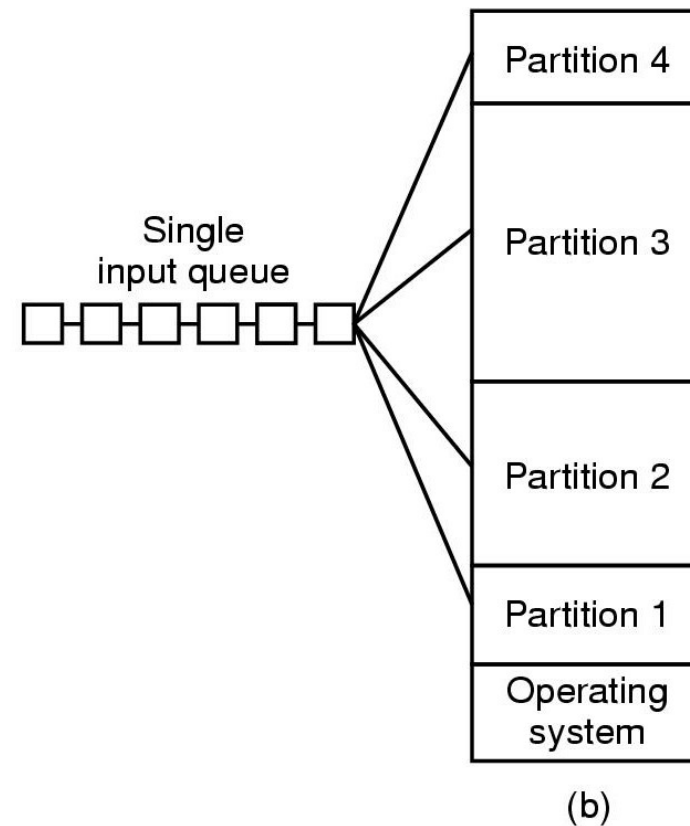

Fixed Partition Summary

- Simple
- Easy to implement
- Can result in poor memory utilisation
 - Due to internal fragmentation
- Used on IBM System 360 operating system (OS/MFT)
 - Announced 6 April, 1964
- Still applicable for simple embedded systems
 - Static workload known in advance

Dynamic Partitioning

- Partitions are of variable length
 - Allocated on-demand from ranges of free memory
- Process is allocated exactly what it needs
 - Assumes a process knows what it needs

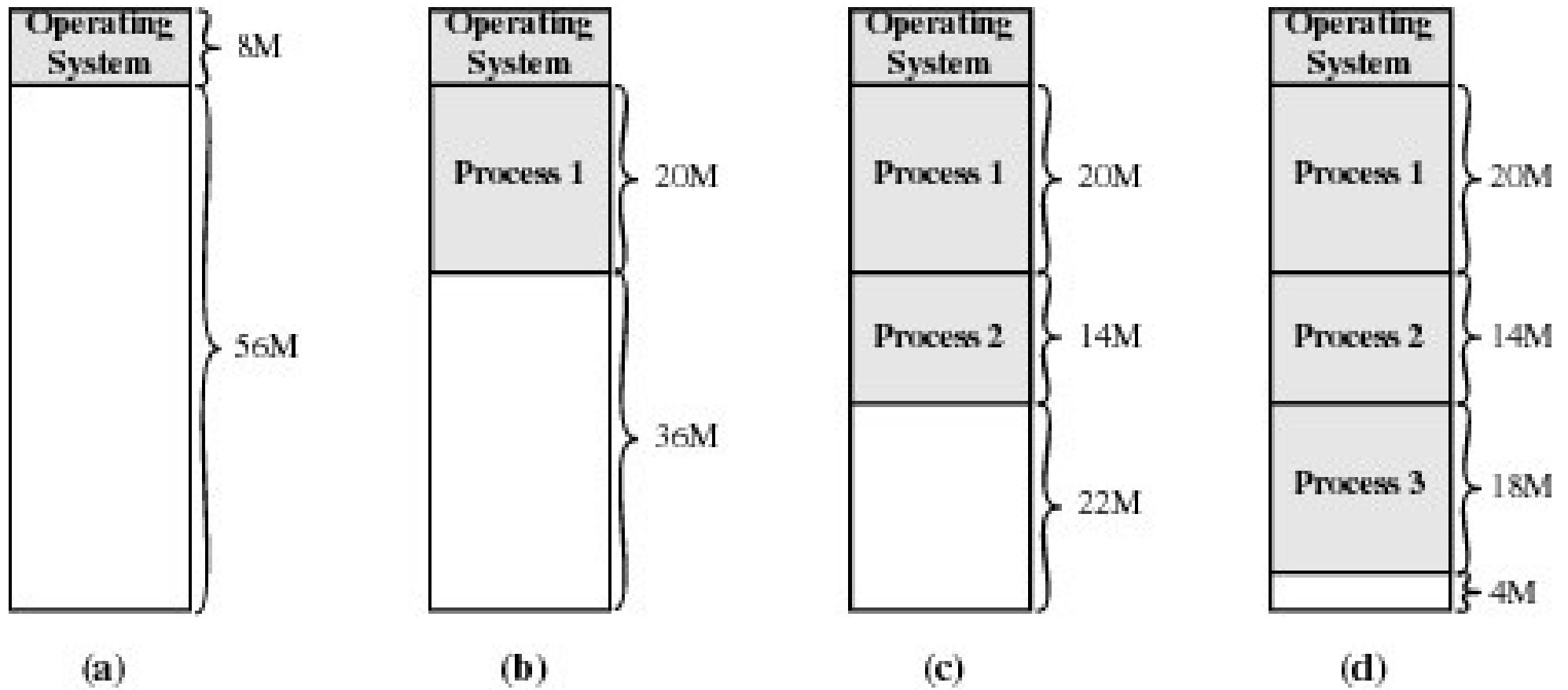

Figure 7.4 The Effect of Dynamic Partitioning

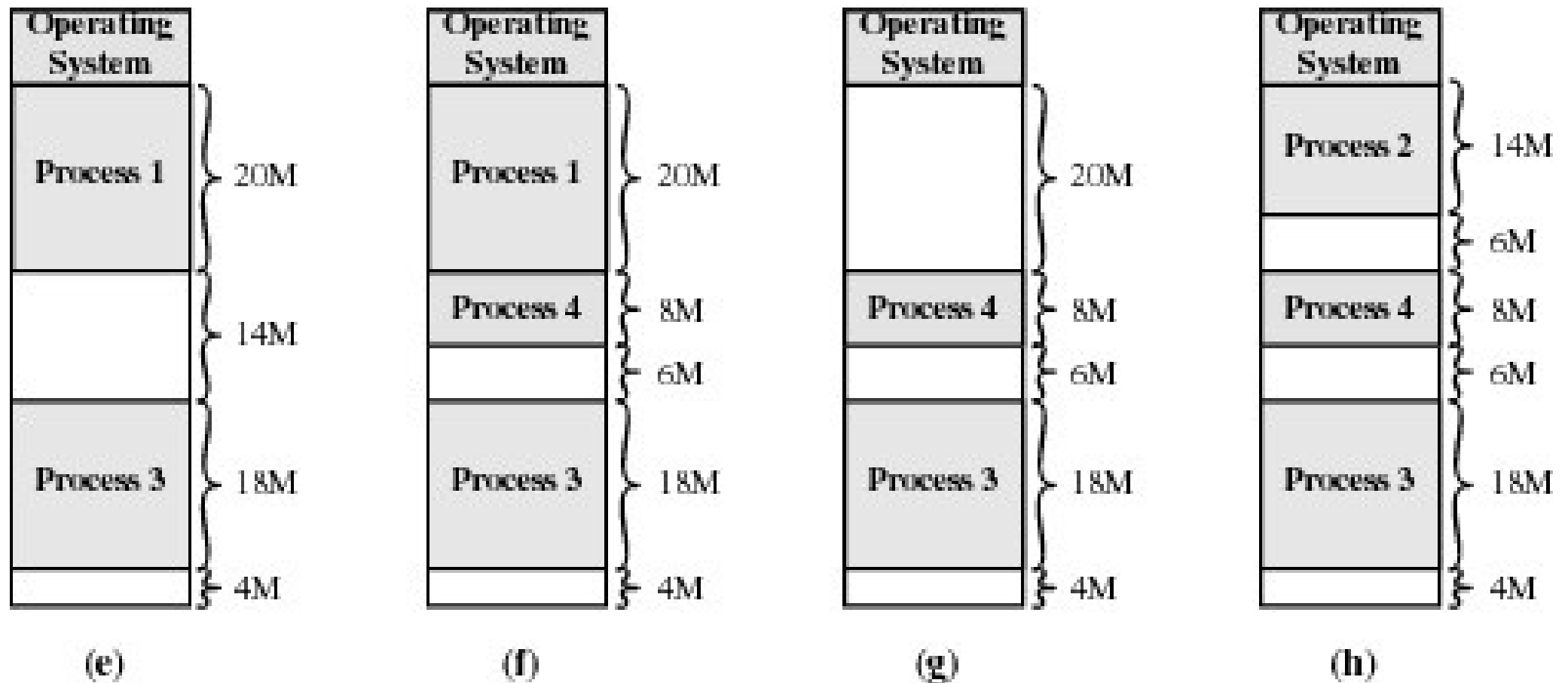

Figure 7.4 The Effect of Dynamic Partitioning

Dynamic Partitioning

- In previous diagram
 - We have 16 meg free in total, but it can't be used to run any more processes requiring > 6 meg as it is fragmented
 - Called *external fragmentation*
- We end up with unusable holes

Recap: Fragmentation

- **External Fragmentation:**

- The space wasted external to the allocated memory regions.
- Memory space exists to satisfy a request, but it is unusable as it is not contiguous.

- **Internal Fragmentation:**

- The space wasted internal to the allocated memory regions.
- allocated memory may be slightly larger than requested memory; this size difference is wasted memory internal to a partition.

Dynamic Partition Allocation Algorithms

- Also applicable to `malloc()`-like in-application allocators
- Given a region of memory, basic requirements are:
 - Quickly locate a free partition satisfying the request
 - Minimise CPU time search
 - Minimise external fragmentation
 - Minimise memory overhead of bookkeeping
 - Efficiently support merging two adjacent free partitions into a larger partition

Classic Approach

- Represent available memory as a linked list of available “holes” (free memory ranges).
 - Base, size
 - Kept in order of increasing address
 - Simplifies merging of adjacent holes into larger holes.
 - List nodes be stored in the “holes” themselves

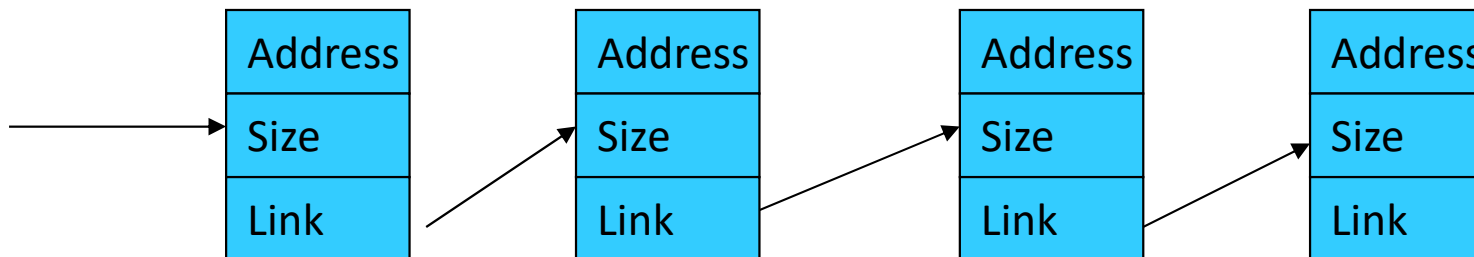

Coalescing Free Partitions with Linked Lists

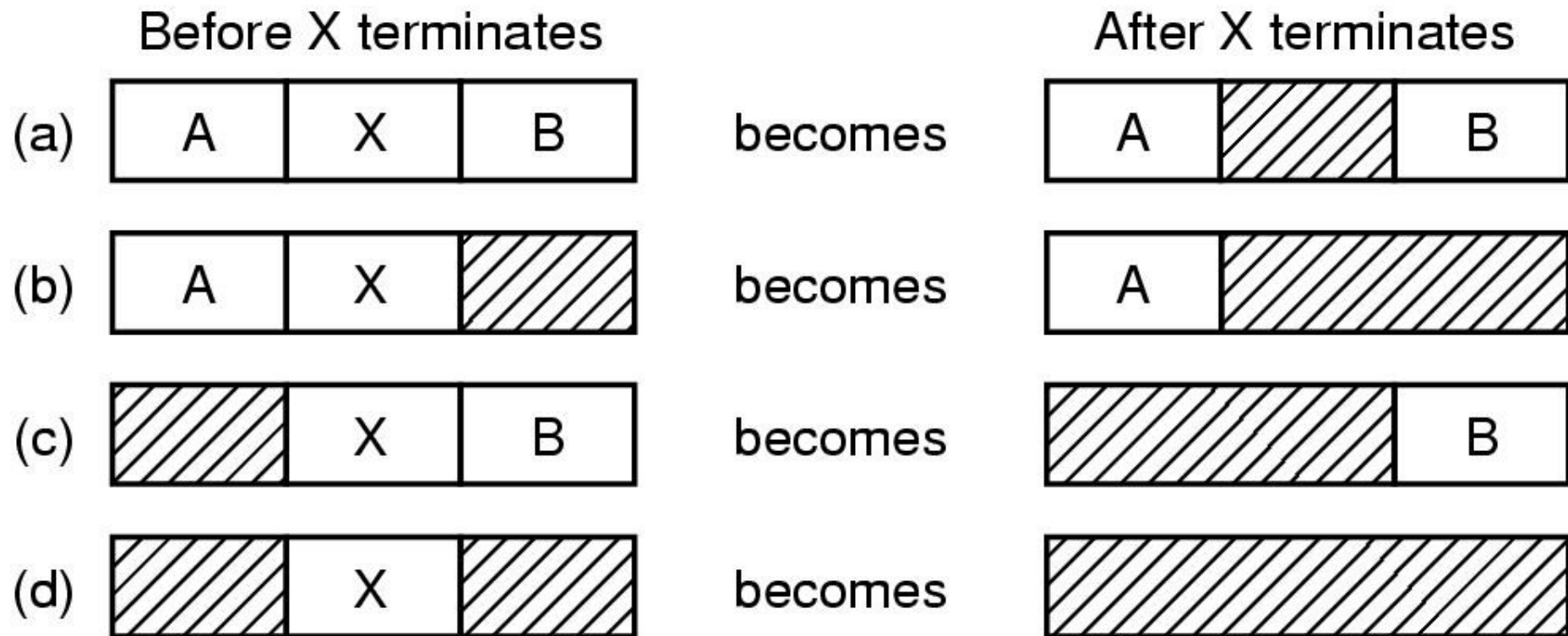

Four neighbor combinations for the terminating process X

Dynamic Partitioning Placement Algorithm

- First-fit algorithm
 - Scan the list for the first entry that fits
 - If greater in size, break it into an allocated and free part
 - Intent: Minimise amount of searching performed
 - Aims to find a match quickly
 - Biases allocation to one end of memory
 - Tends to preserve larger blocks at the end of memory

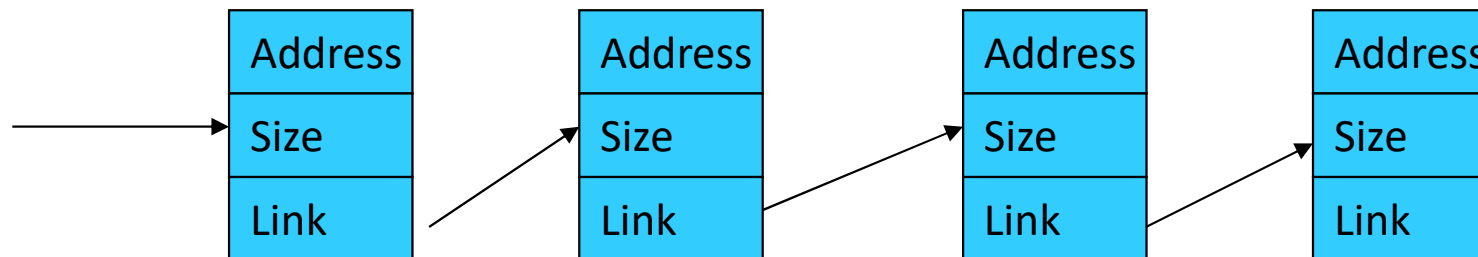

Dynamic Partitioning Placement Algorithm

- Next-fit

- Like first-fit, except it begins its search from the point in list where the last request succeeded instead of at the beginning.
 - (Flawed) Intuition: spread allocation more uniformly over entire memory to avoid skipping over small holes at start of memory
 - Performs worse than first-fit as it breaks up the large free space at end of memory.

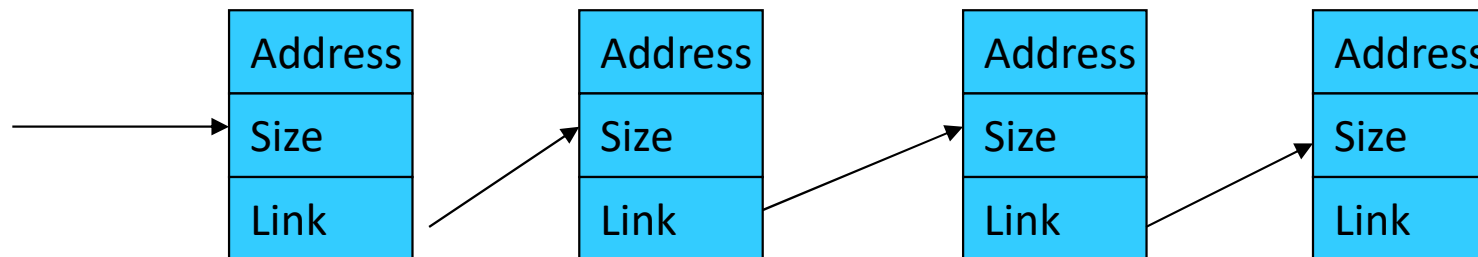

Dynamic Partitioning Placement Algorithm

- Best-fit algorithm

- Chooses the block that is closest in size to the request
- Performs worse than first-fit
 - Has to search complete list
 - does more work than first-fit
 - Since smallest block is chosen for a process, the smallest amount of external fragmentation is left
 - Create lots of unusable holes

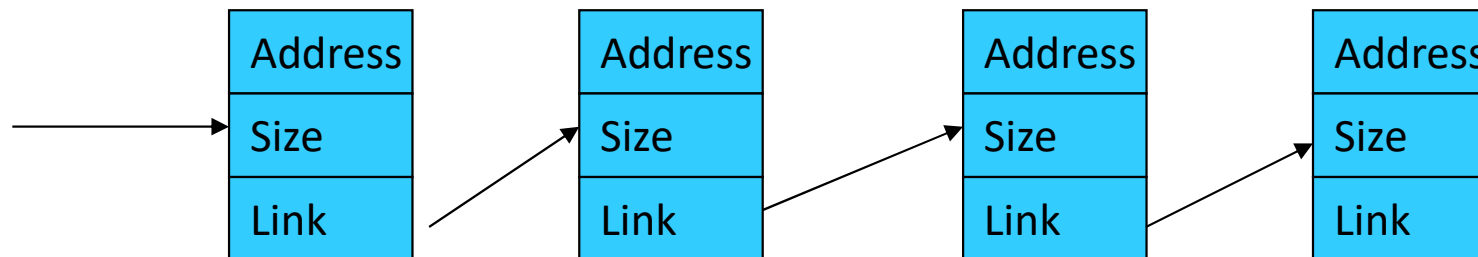

Dynamic Partitioning Placement Algorithm

- **Worst-fit algorithm**

- Chooses the block that is largest in size (worst-fit)
 - (whimsical) idea is to leave a usable fragment left over
- Poor performer
 - Has to do more work (like best fit) to search complete list
 - Does not result in significantly less fragmentation

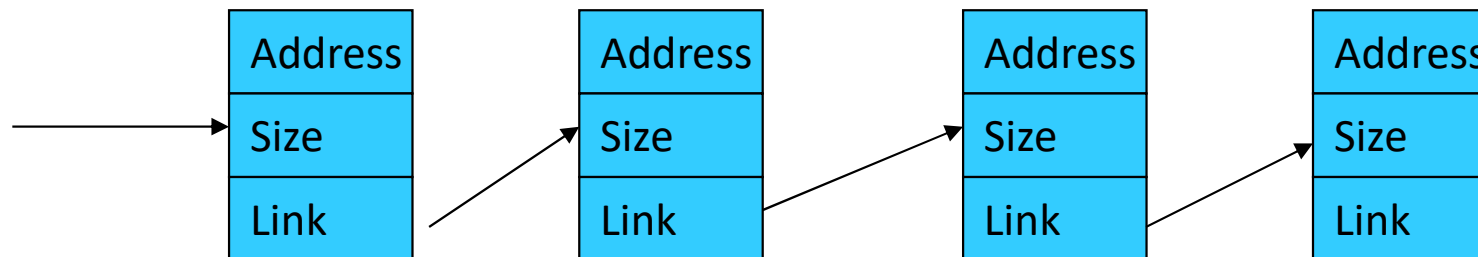

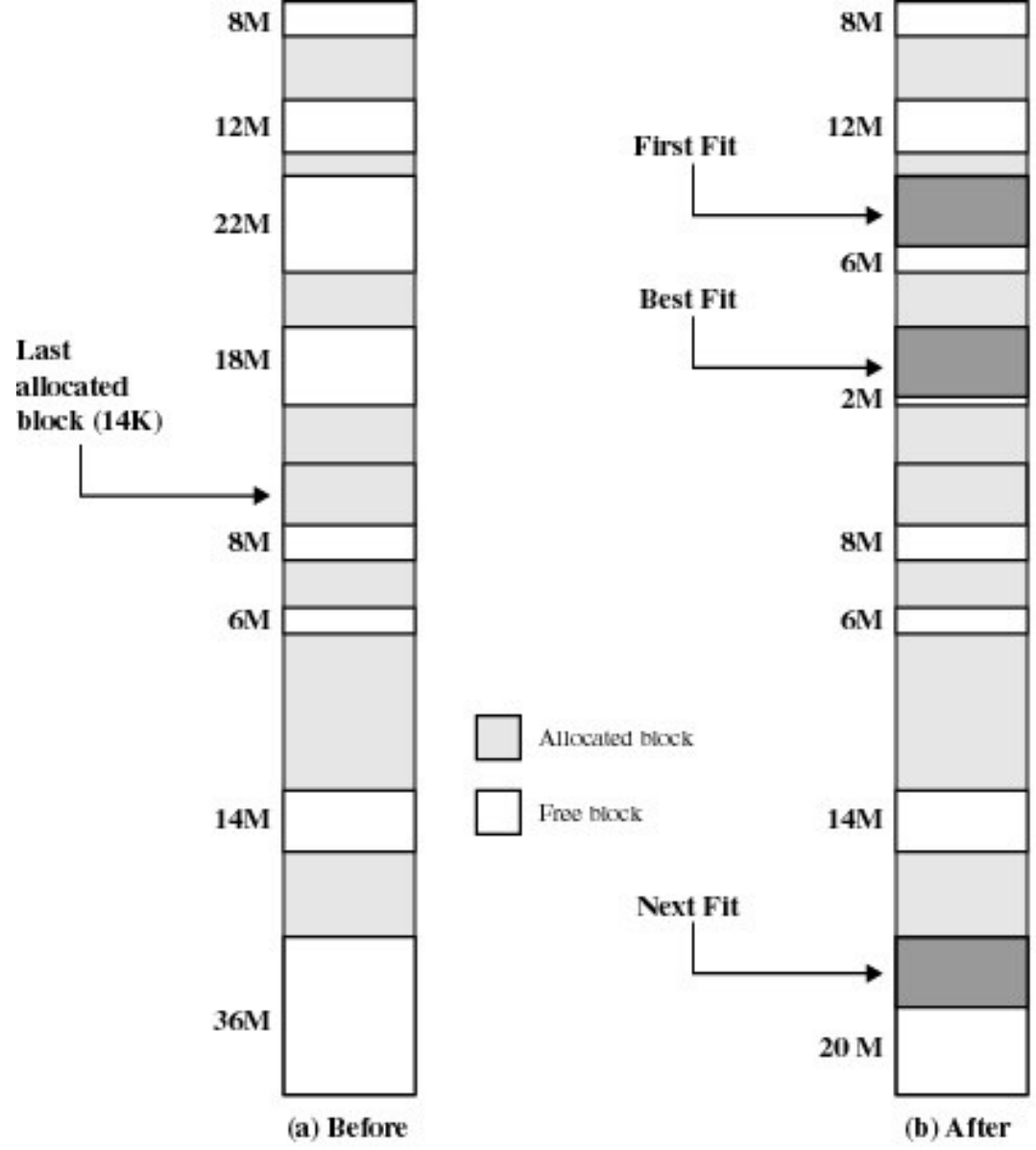

Figure 7.5 Example Memory Configuration Before and After Allocation of 16 Mbyte Block

Dynamic Partition Allocation Algorithm

- Summary
 - First-fit generally better than the others and easiest to implement
- You should be aware of them
 - They are simple solutions to a still-existing OS or application service/function – memory allocation.
- Note: Largely have been superseded by more complex and specific allocation strategies
 - Typical in-kernel allocators used are *lazy buddy*, and *slab* allocators

Compaction

- We can reduce external fragmentation by compaction
 - Shuffle memory contents to place all free memory together in one large block.
 - Only if we can relocate running programs?
 - Pointers?
 - Generally requires hardware support

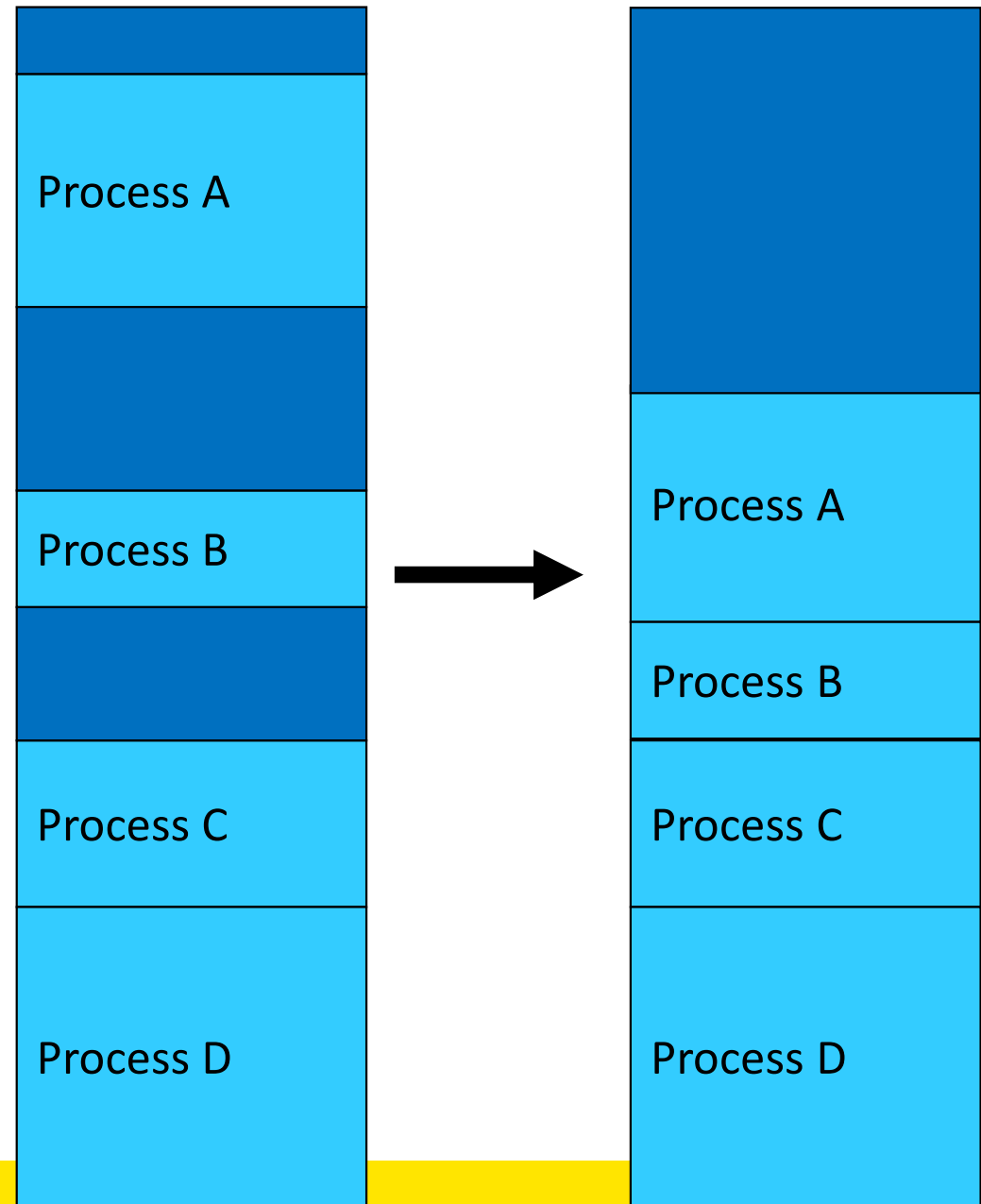

Some Remaining Issues with Dynamic Partitioning

- We have ignored
 - Relocation
 - How does a process run in different locations in memory?
 - Protection
 - How do we prevent processes interfering with each other

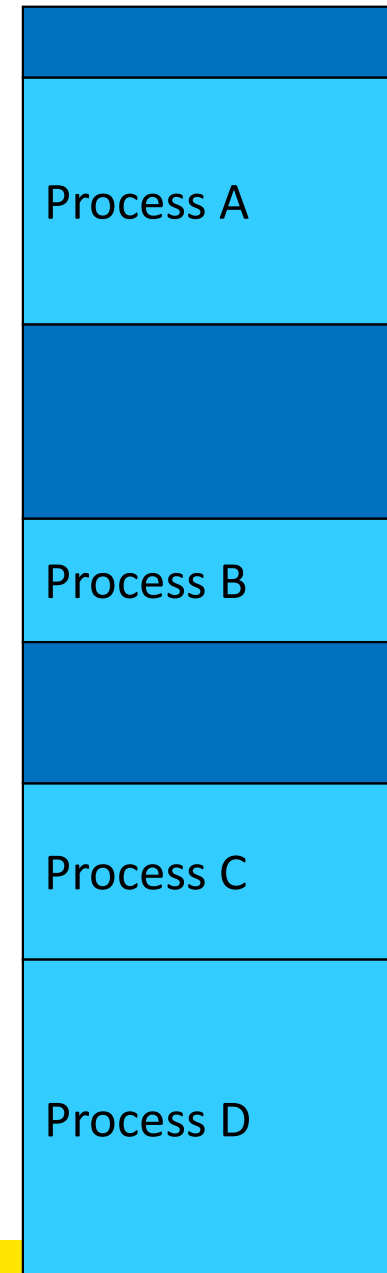

Example Logical Address-Space Layout

- Logical addresses refer to specific locations within the program
- Once running, these address must refer to real physical memory
- When are logical addresses bound to physical?

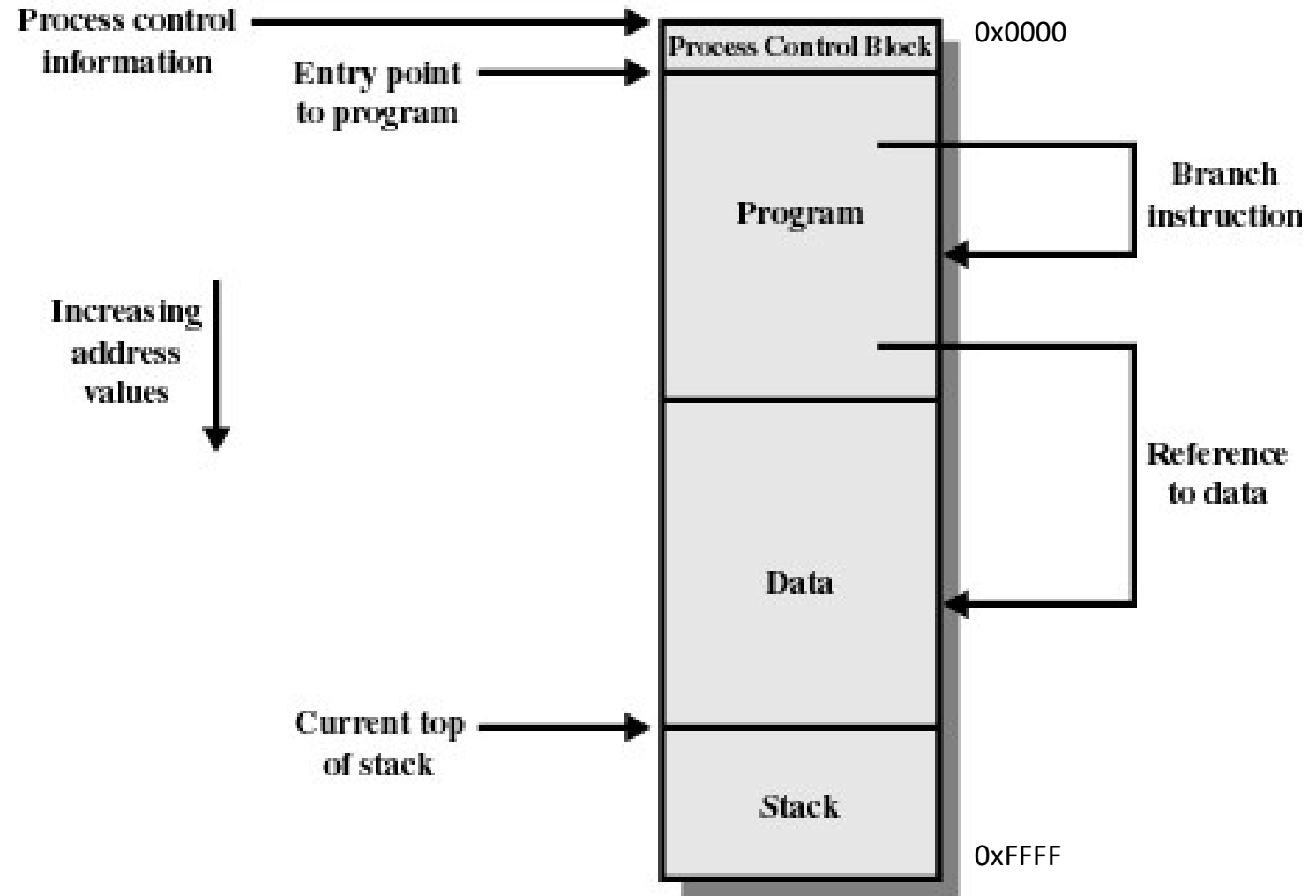
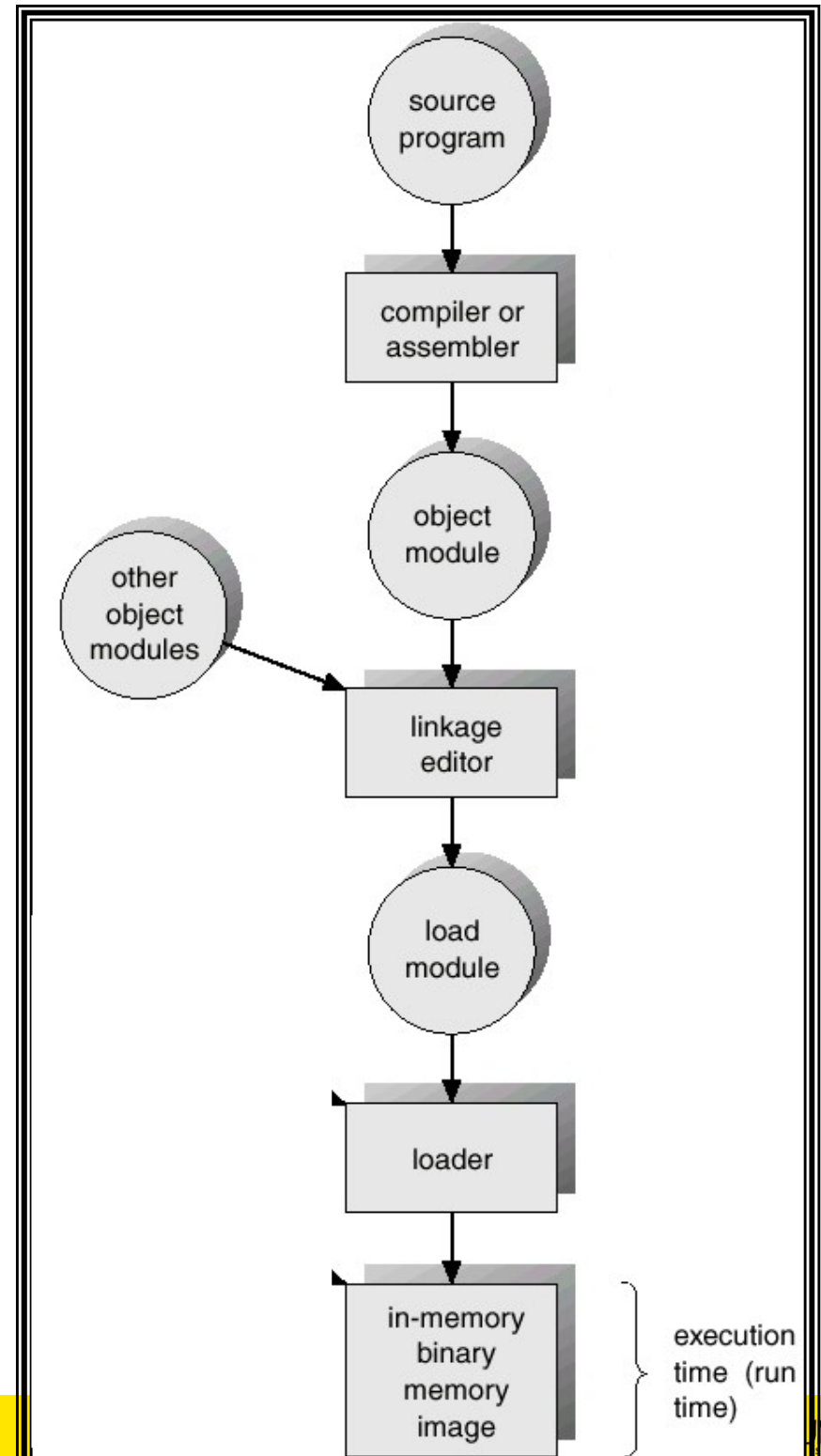

Figure 7.1 Addressing Requirements for a Process

When are memory addresses bound?

- Compile/link time
 - Compiler/Linker binds the addresses
 - Must know “run” location at compile time
 - Recompile if location changes
- Load time
 - Compiler generates *relocatable* code
 - Loader binds the addresses at load time
- Run time
 - Logical compile-time addresses translated to physical addresses by *special hardware*.



Hardware Support for Runtime Binding and Protection

- For process B to run using logical addresses
 - Process B expects to access addresses from zero to some limit of memory size

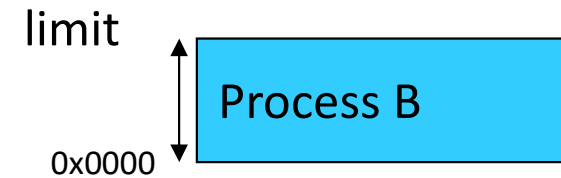

Hardware Support for Runtime Binding and Protection

- For process B to run using logical addresses
 - Need to add an appropriate offset to its logical addresses
 - Achieve relocation
 - Protect memory “lower” than B
 - Must limit the maximum logical address B can generate
 - Protect memory “higher” than B

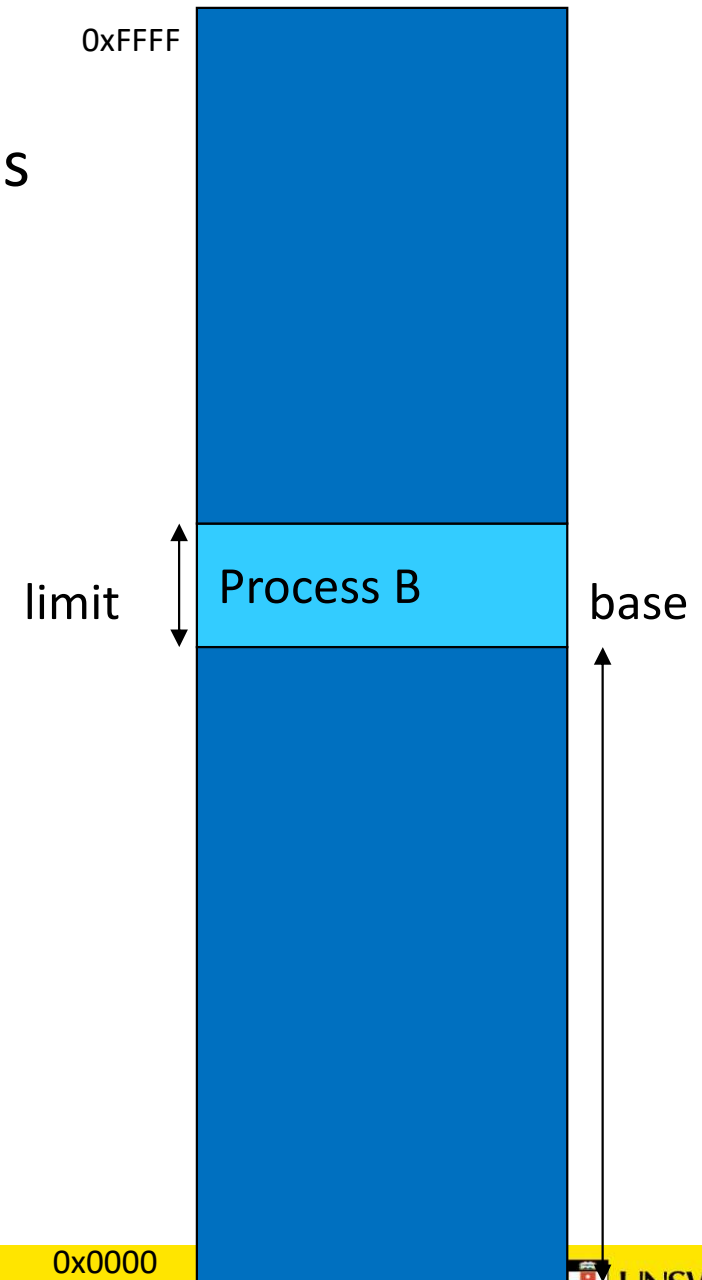

Hardware Support for Relocation and Limit Registers

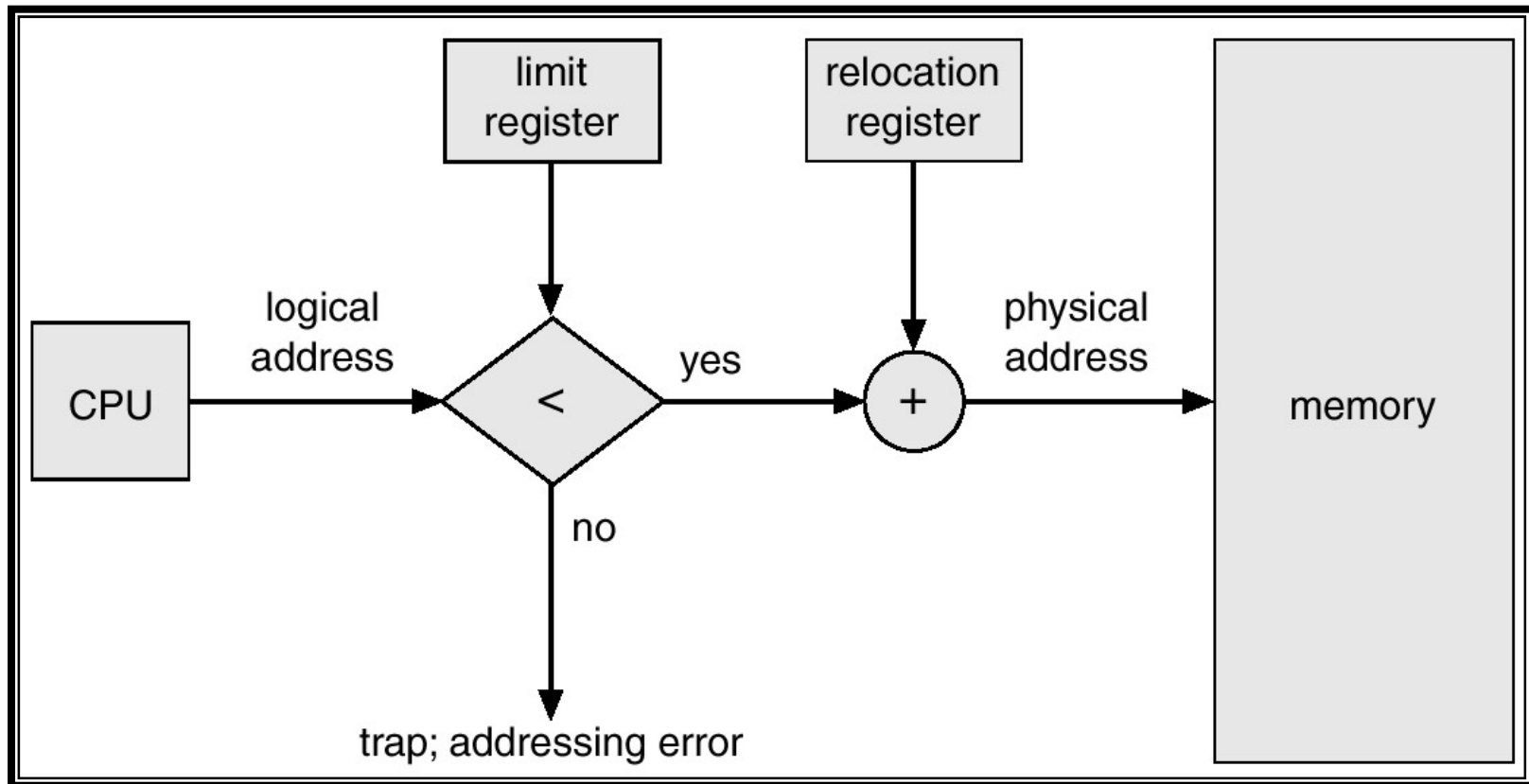

Base and Limit Registers

- Also called
 - Base and bound registers
 - Relocation and limit registers
- Base and limit registers
 - Restrict and relocate the currently active process
 - Base and limit registers must be changed at
 - Load time
 - Relocation (compaction time)
 - On a context switch

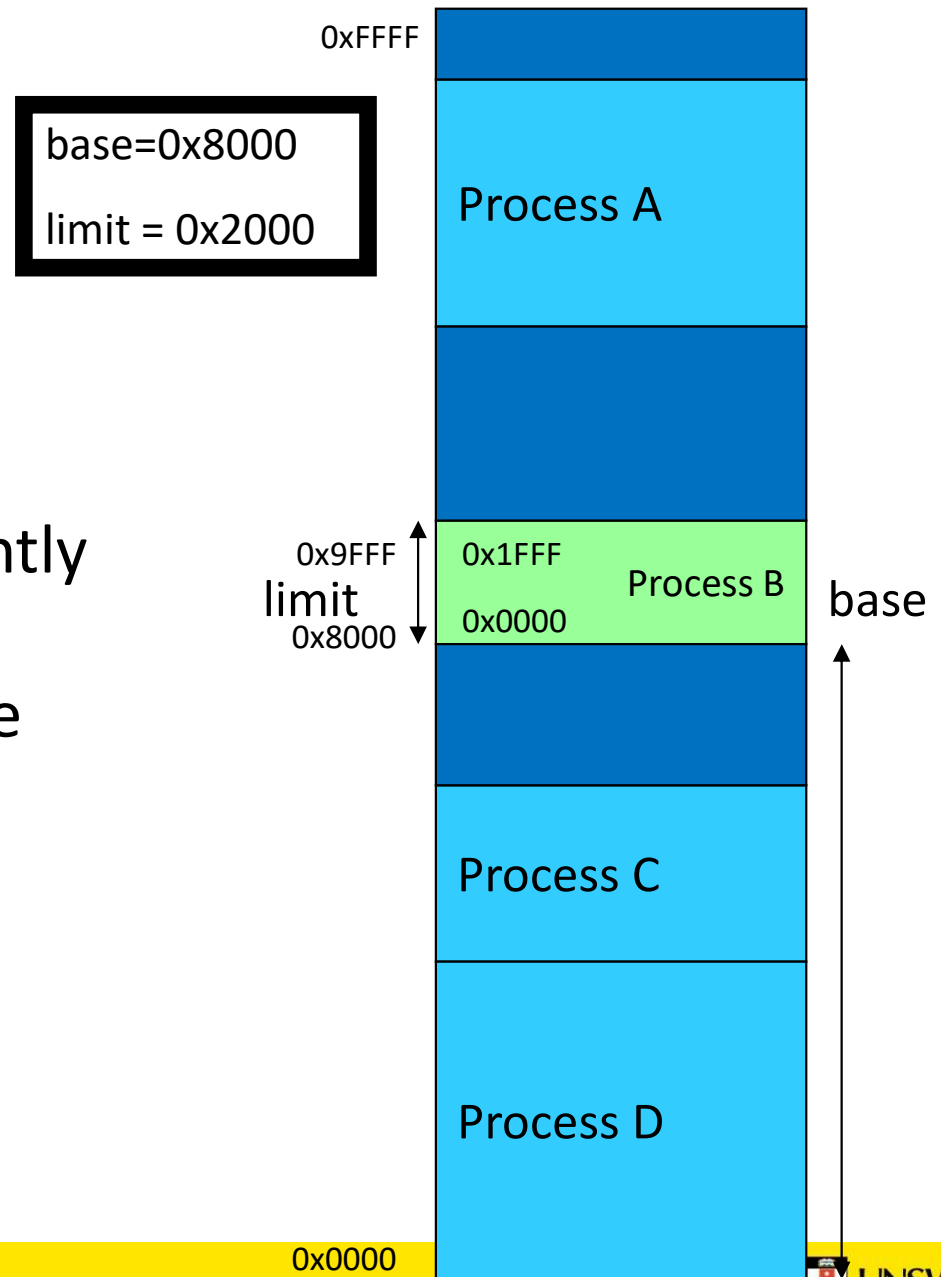

Base and Limit Registers

- Also called
 - Base and bound registers
 - Relocation and limit registers
- Base and limit registers
 - Restrict and relocate the currently active process
 - Base and limit registers must be changed at
 - Load time
 - Relocation (compaction time)
 - On a context switch

base=0x4000
limit = 0x3000

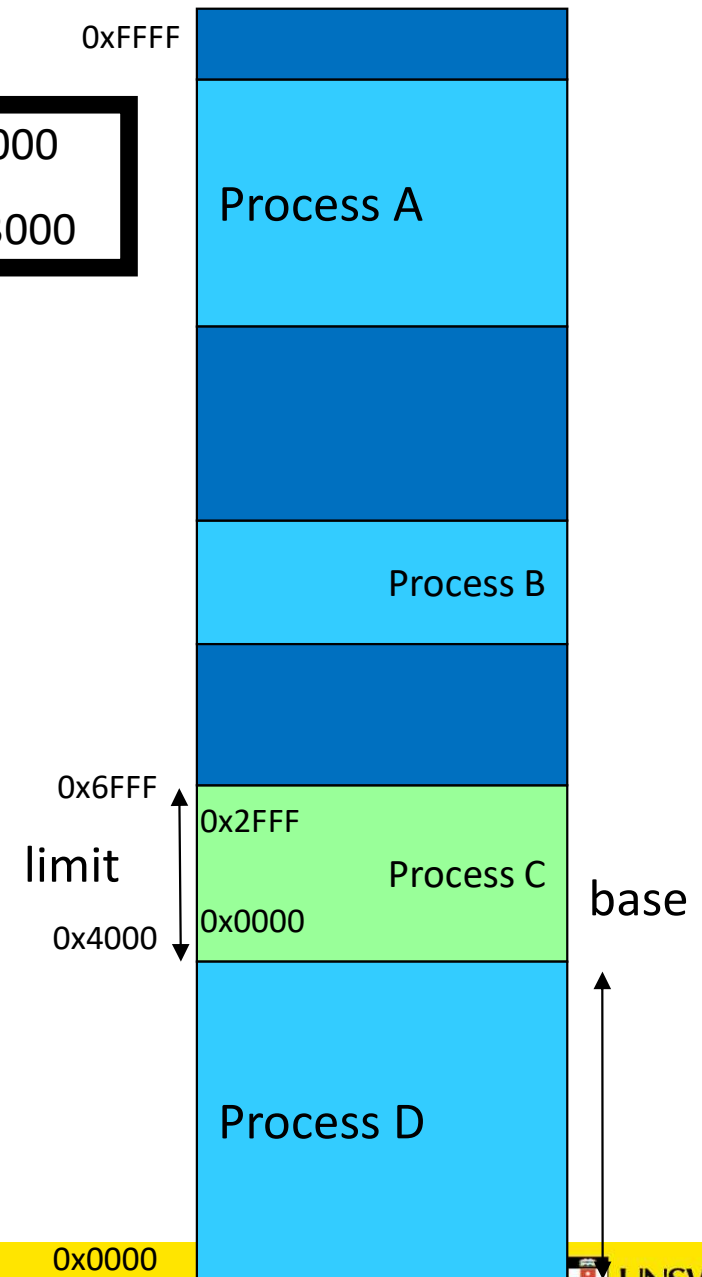

Base and Limit Registers

- Pro
 - Supports protected multi-processing (-tasking)
- Cons
 - Physical memory allocation must still be contiguous
 - The entire process must be in memory
 - Do not support partial sharing of address spaces
 - No shared code, libraries, or data structures between processes

Timesharing

- Thus far, we have a system suitable for a batch system
 - Limited number of dynamically allocated processes
 - Enough to keep CPU utilised
 - Relocated at runtime
 - Protected from each other
- But what about timesharing?
 - We need more than just a small number of processes running at once
 - Need to support a mix of active and inactive processes, of varying longevity

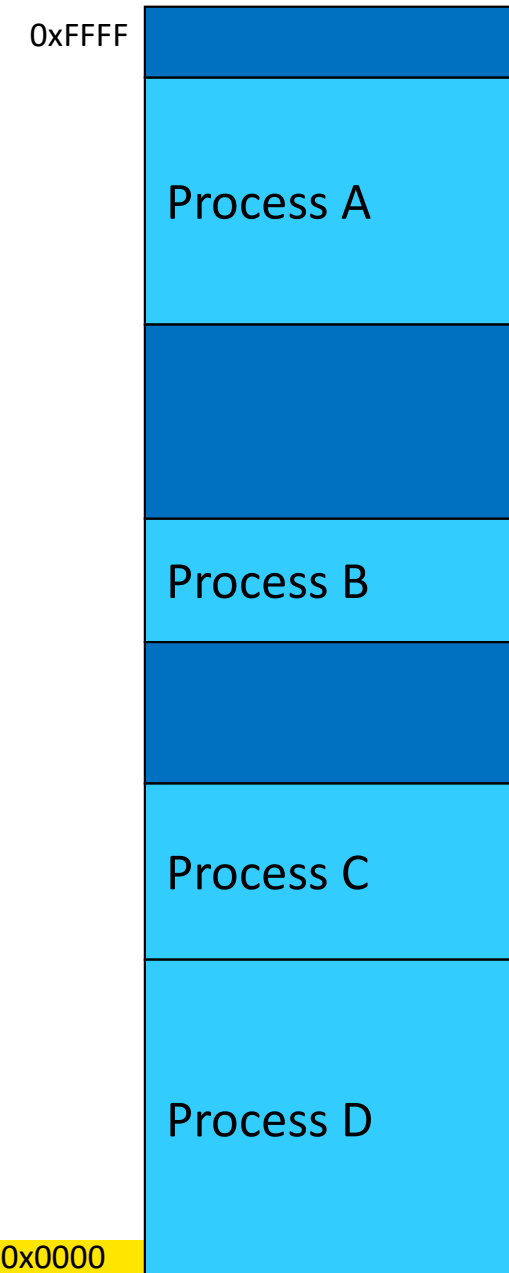

Swapping

- A process can be *swapped* temporarily out of memory to a *backing store*, and then brought back into memory for continued execution.
- Swapping involves transferring the whole process
- Backing store – fast disk large enough to accommodate copies of all memory images for all users; must provide direct access to these memory images.
- Can prioritize – lower-priority process is swapped out so higher-priority process can be loaded and executed.
- Major part of swap time is transfer time; total transfer time is directly proportional to the *amount* of memory swapped.
 - slow

Schematic View of Swapping

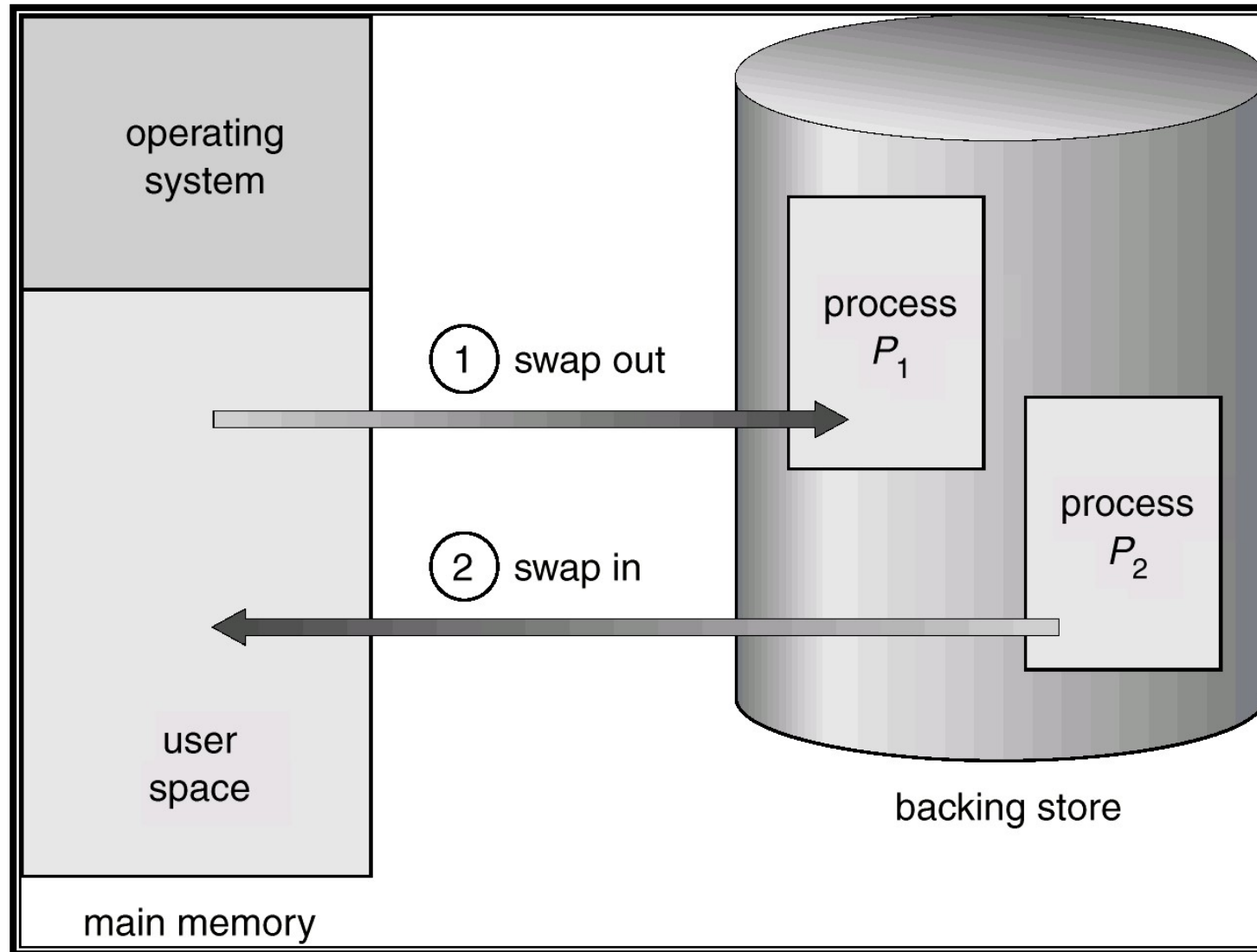

So far we have assumed a process is smaller than memory

- What can we do if a process is larger than main memory?

Virtual Memory

- Developed to address the issues identified with the simple schemes covered thus far.
- Two classic variants
 - Paging
 - Segmentation
 - (no longer covered in course, see textbook if interested)
- Paging is now the dominant one of the two
 - We'll focus on it
- Some architectures support hybrids of the two schemes
 - E.g. Intel IA-32 (32-bit x86)
 - Becoming less relevant

Virtual Memory – Paging Overview

- Partition physical memory into small equal sized chunks
 - Called *frames*
- Divide each process's virtual (logical) address space into same size chunks
 - Called *pages*
 - Virtual memory addresses consist of a *page number* and *offset* within the page
- OS maintains a *page table*
 - contains the frame location for each page
 - Used by *hardware* to translate each virtual address to physical address
 - The relation between virtual addresses and physical memory addresses is given by page table
- Process's physical memory does **not** have to be contiguous

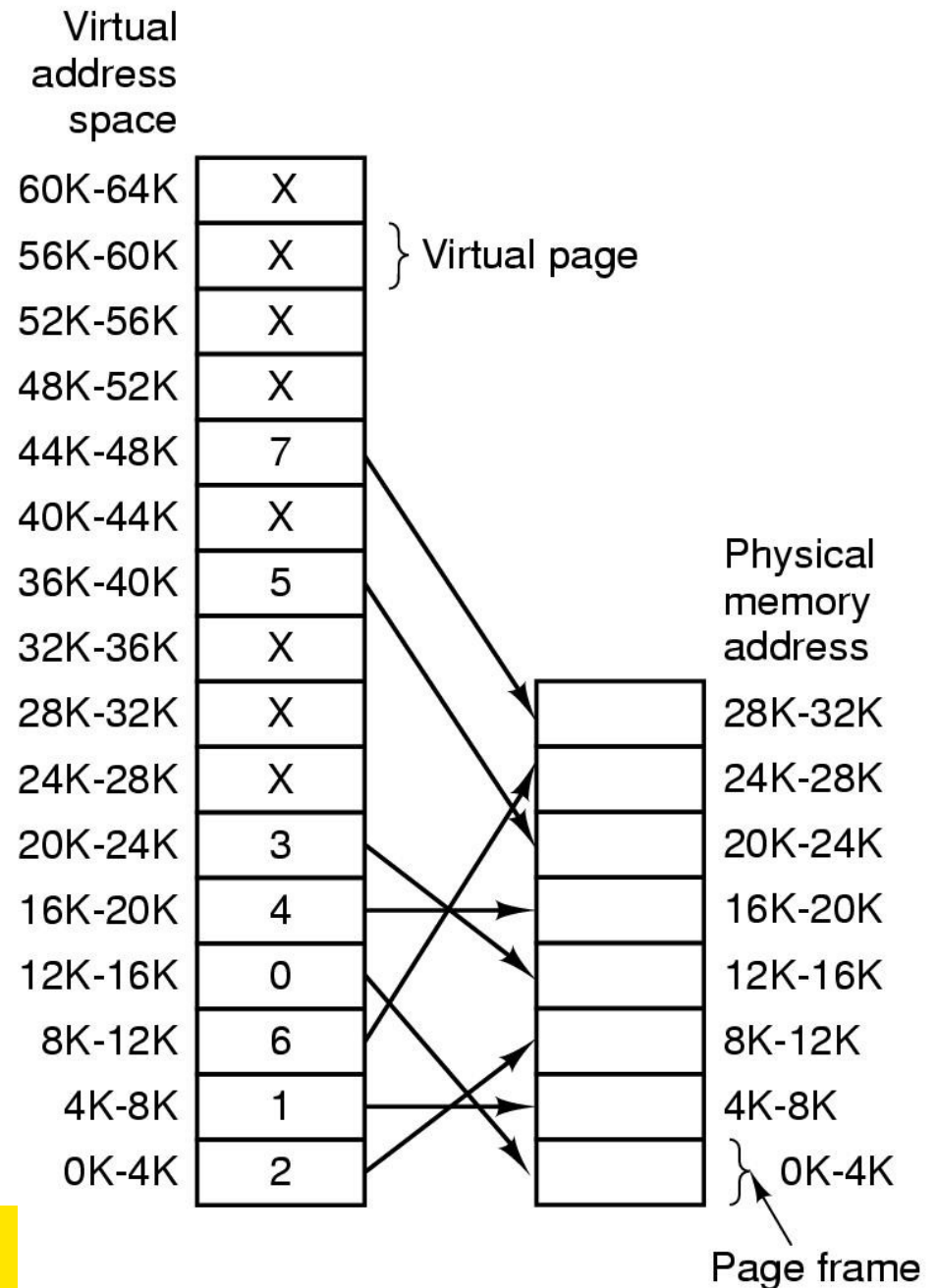

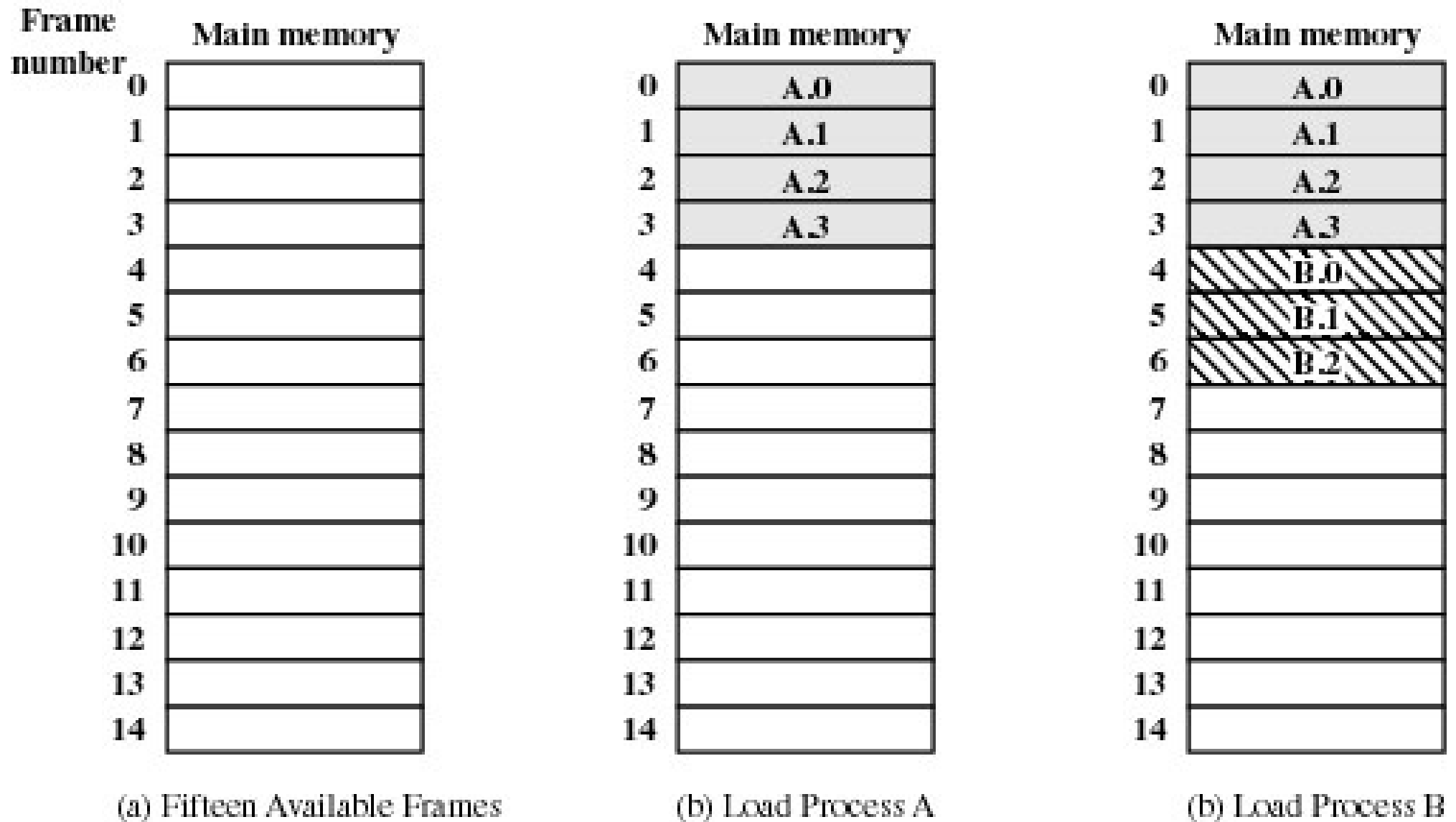
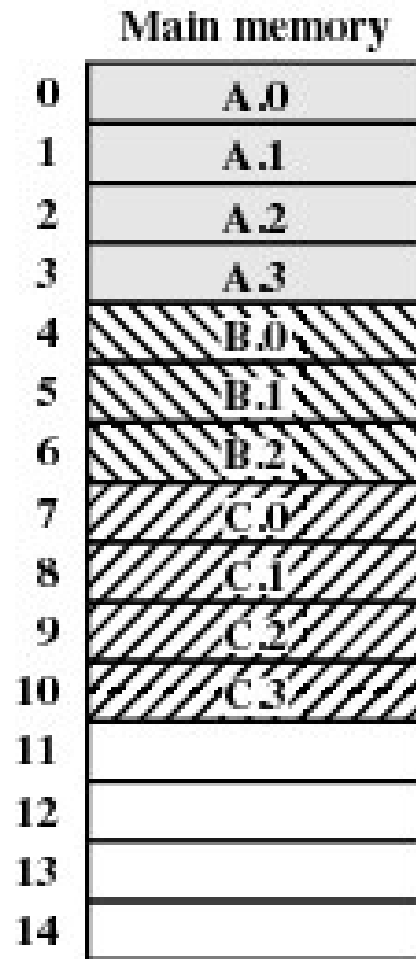
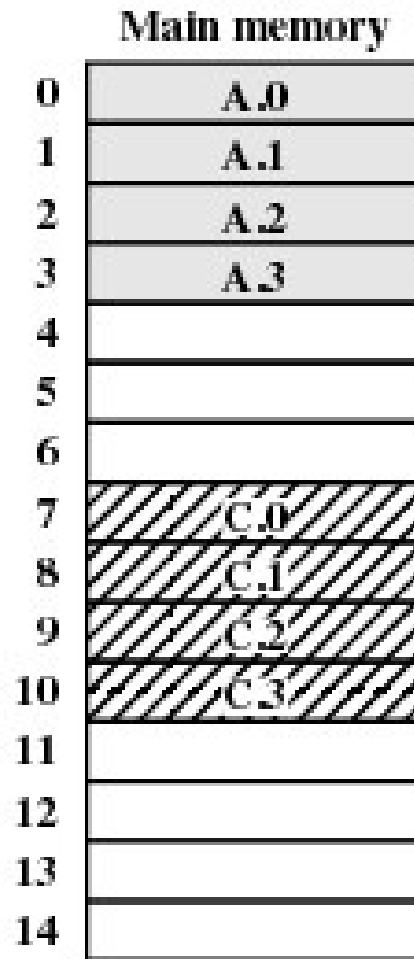

Figure 7.9 Assignment of Process Pages to Free Frames



(d) Load Process C



(e) Swap out B

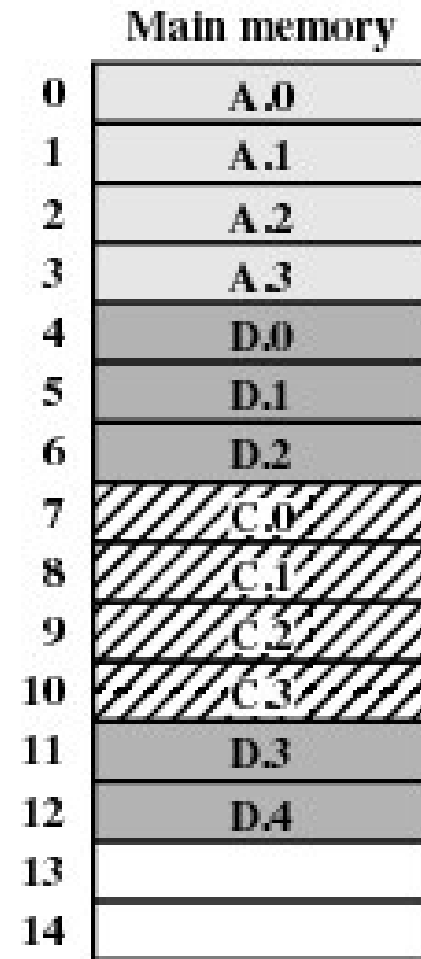

(f) Load Process D

0	0
1	1
2	2
3	3

Process A
page table

0	—
1	—
2	—

Process B
page table

0	7
1	8
2	9
3	10

Process C
page table

0	4
1	5
2	6
3	11
4	12

Process D
page table

13
14

Free frame
list

Paging

- No external fragmentation
- Small internal fragmentation (in last page)
- Allows sharing by *mapping* several pages to the same frame
- Abstracts physical organisation
 - Programmer only deal with virtual addresses
- Minimal support for logical organisation
 - Each unit is one or more pages

Memory Management Unit (also called Translation Look-aside Buffer – TLB)

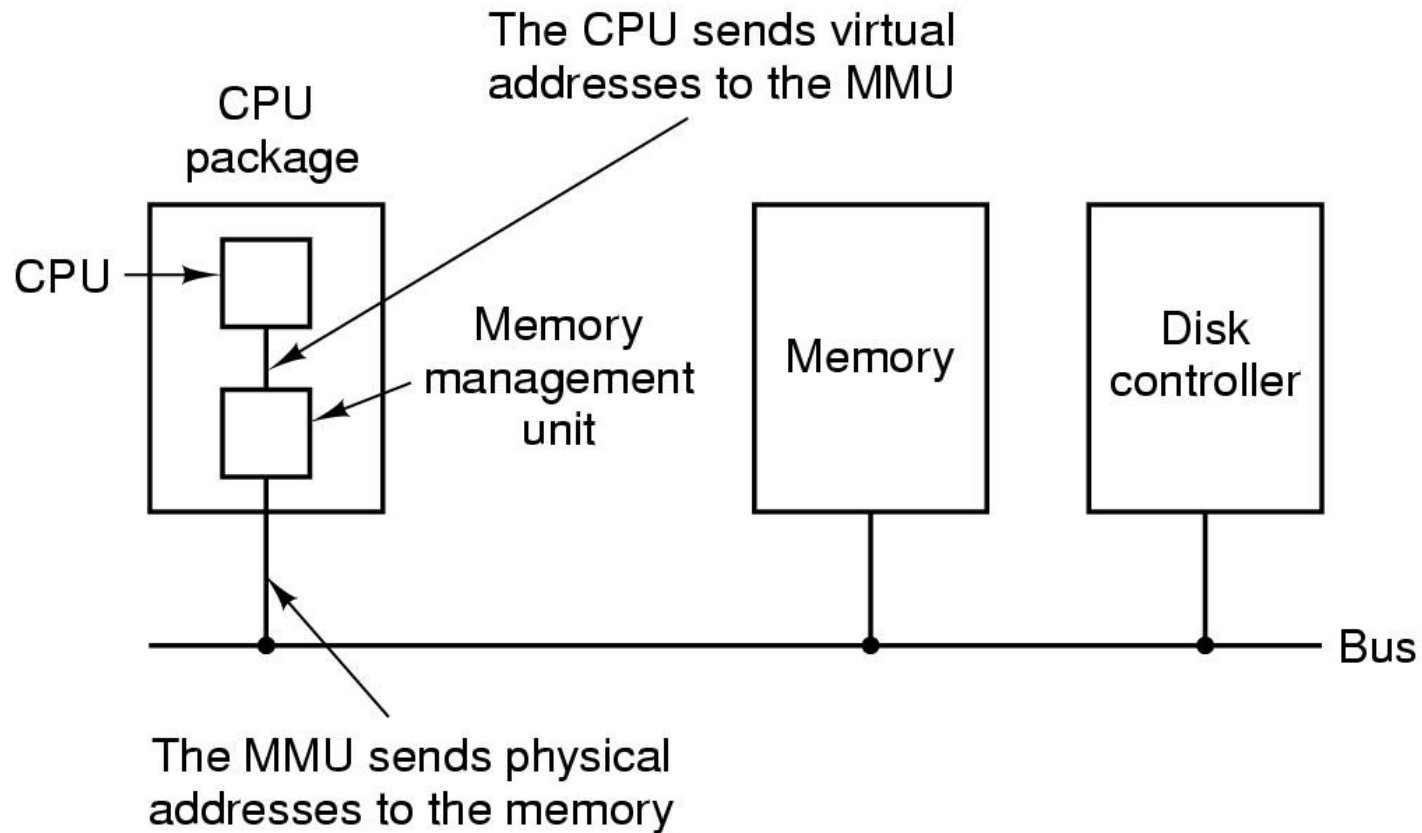

The position and function of the MMU

MMU Operation

Assume for now that the page table is contained wholly in registers within the MMU – in practice it is not

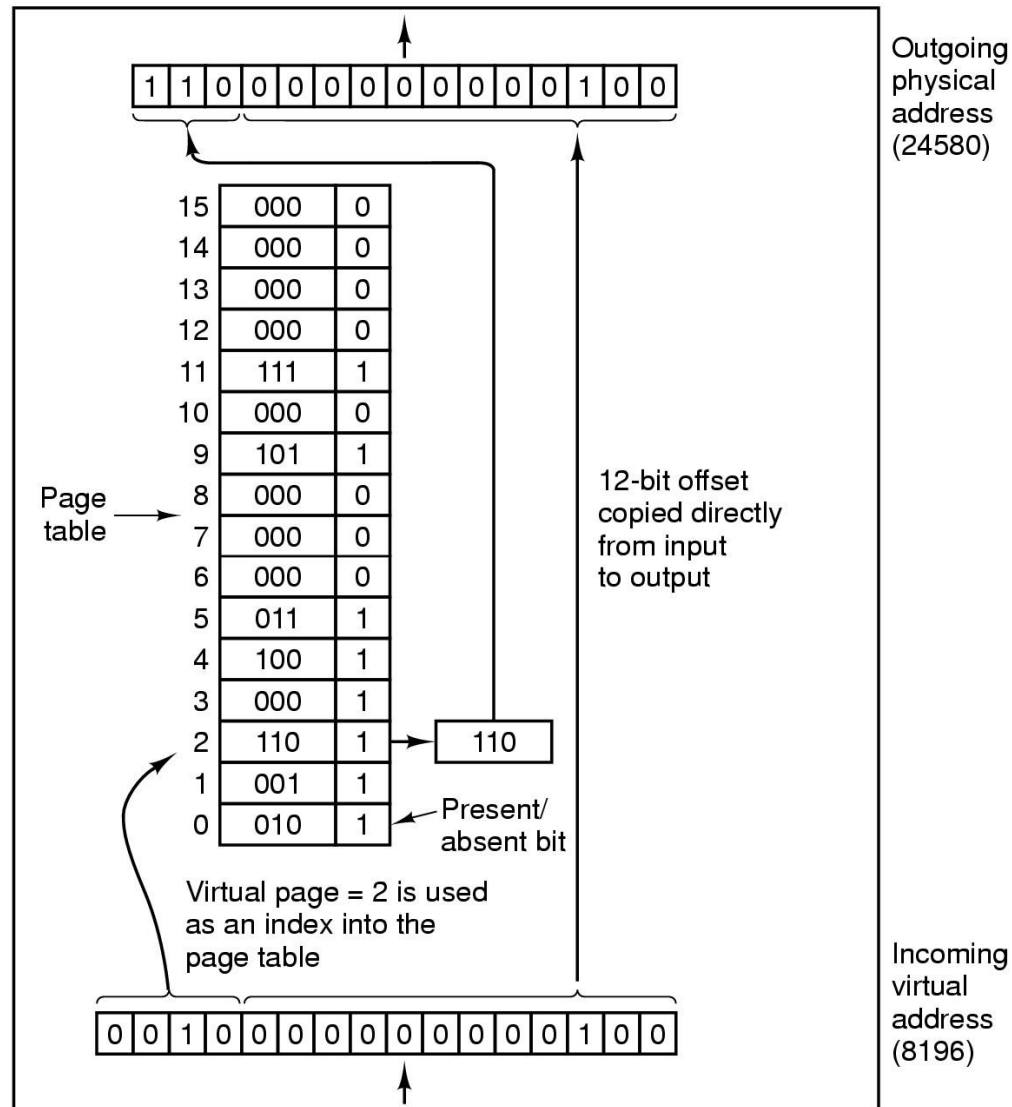

Internal operation of simplified MMU with 16 4 KB pages