

# Processes and Threads Implementation

# Learning Outcomes

- A basic understanding of the MIPS R3000 assembly and compiler generated code.
- An understanding of the typical implementation strategies of processes and threads
  - Including an appreciation of the trade-offs between the implementation approaches
    - Kernel-threads versus user-level threads
- A detailed understanding of “context switching”

# MIPS R3000

- Load/store architecture
  - No instructions that operate on memory except load and store
  - Simple load/stores to/from memory from/to registers
    - Store word: **sw r4, (r5)**
      - Store contents of r4 in memory using address contained in register r5
    - Load word: **lw r3, (r7)**
      - Load contents of memory into r3 using address contained in r7
      - Delay of one instruction after load before data available in destination register
        - Must always an instruction between a load from memory and the subsequent use of the register.
- **lw, sw, lb, sb, lh, sh,....**

# MIPS R3000

- Arithmetic and logical operations are register to register operations
  - E.g., `add r3, r2, r1`
  - No arithmetic operations on memory
- Example
  - `add r3, r2, r1`  $\Rightarrow r3 = r2 + r1$
- Some other instructions
  - `add, sub, and, or, xor, sll, srl`
  - `move r2, r1`  $\Rightarrow r2 = r1$

# MIPS R3000

- All instructions are encoded in 32-bit
- Some instructions have *immediate* operands
  - Immediate values are constants encoded in the instruction itself
  - Only 16-bit value
  - Examples
    - Add Immediate: `addi r2, r1, 2048`  
⇒  $r2 = r1 + 2048$
    - Load Immediate : `li r2, 1234`  
⇒  $r2 = 1234$

# Example code

Simple code example:  $a = a + 1$

```
lw  r4, 32(r29) // r29 = stack pointer  
li  r5, 1  
add r4, r4, r5  
sw  r4, 32(r29)
```



Offset(Address)

# MIPS Registers

- User-mode accessible registers
  - 32 general purpose registers
    - r0 hardwired to zero
    - r31 the *link* register for jump-and-link (JAL) instruction
  - HI/LO
    - 2 \* 32-bits for multiply and divide
  - PC
    - Not directly visible
    - Modified implicitly by jump and branch instructions

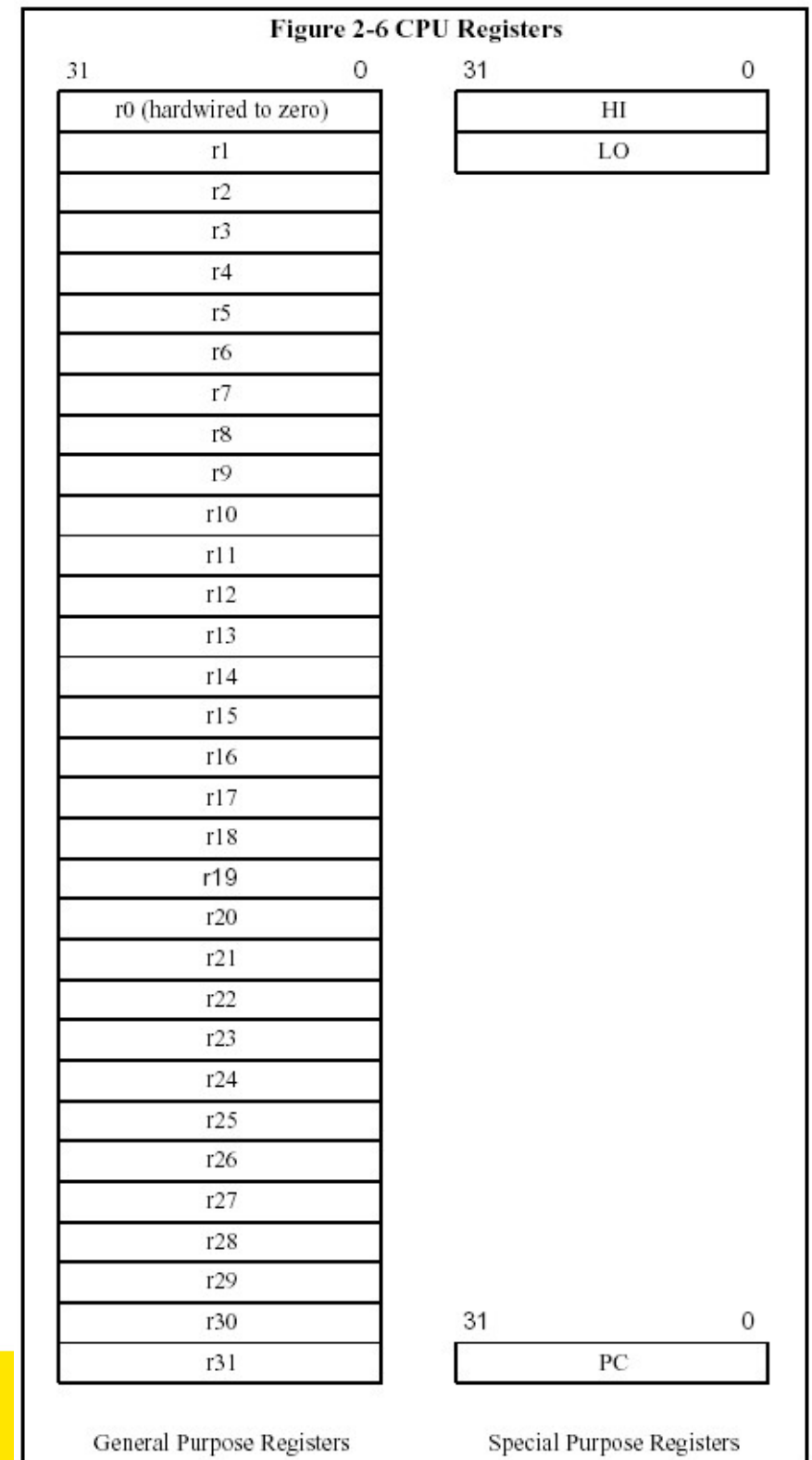

# Branching and Jumping

- Branching and jumping have a *branch delay slot*
  - The instruction following a branch or jump is always executed prior to destination of jump

```
li    r2, 1
```

```
sw   r0, (r3)
```

```
j    1f
```

```
li    r2, 2
```

```
li    r2, 3
```

```
1:   sw   r2, (r3)
```



# MIPS R3000

- RISC architecture – 5 stage pipeline
  - Instruction partially through pipeline prior to jmp having an effect

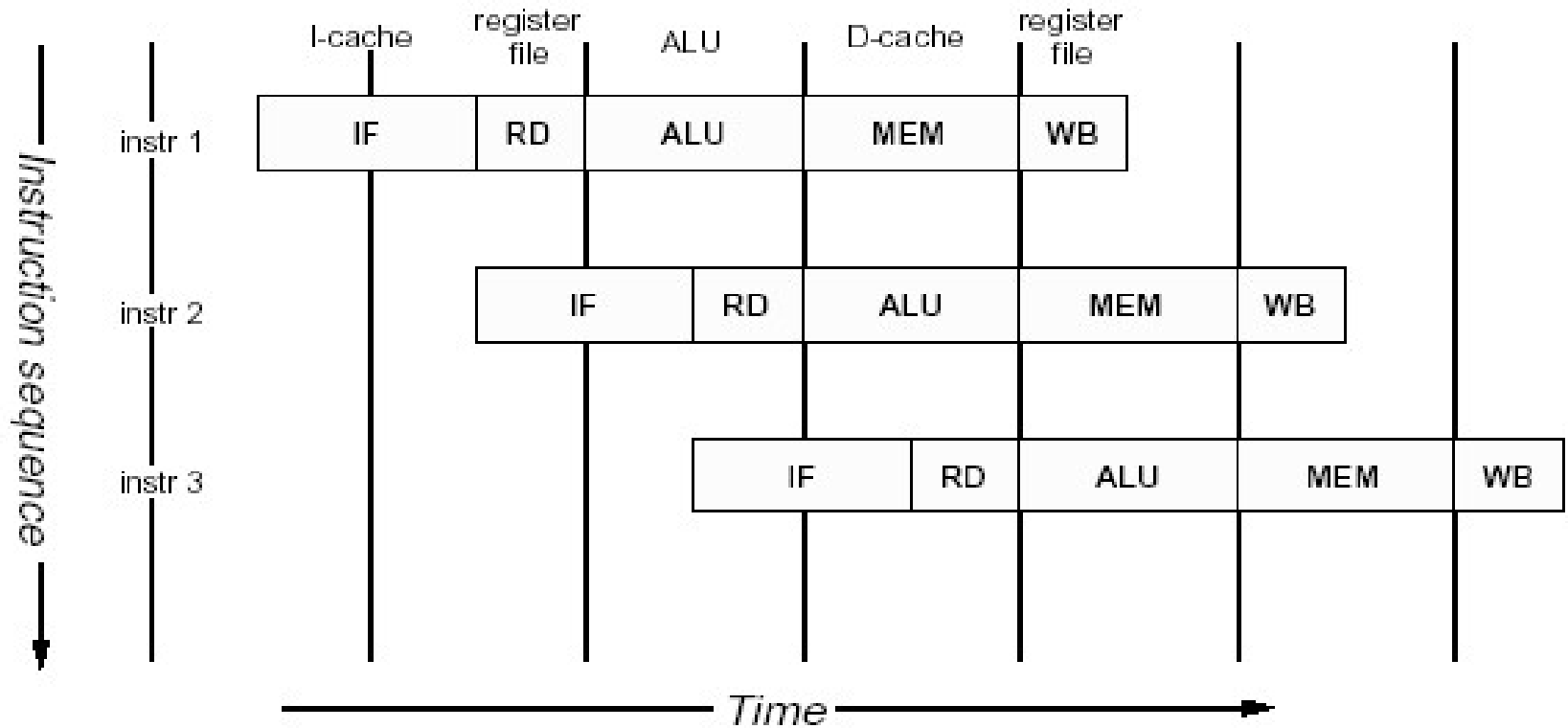
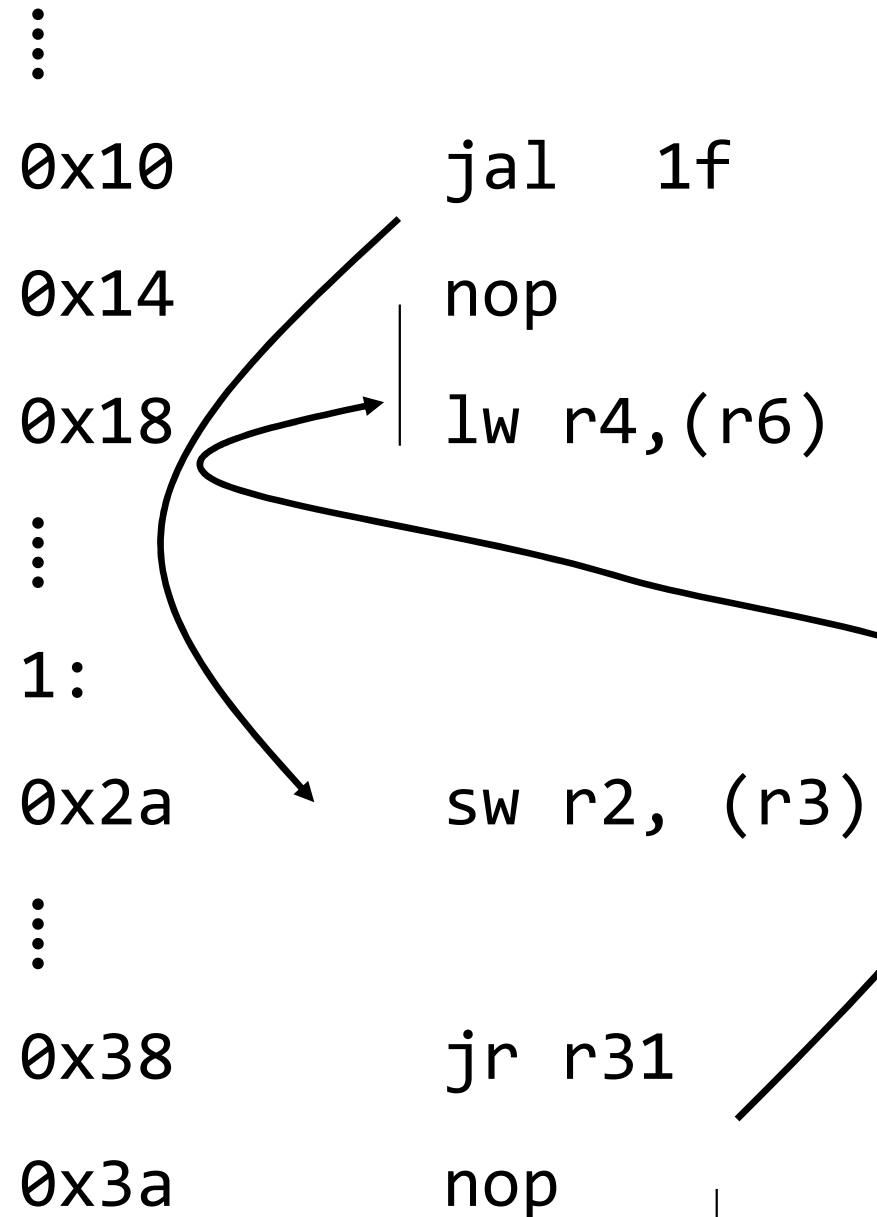

Figure 1.1. MIPS 5-stage pipeline

# Jump and Link Instruction

- JAL is used to implement function calls
  - $r31 = PC+8$
- Return Address register (RA) is used to return from function call



# Compiler Register Conventions

- Given 32 registers, which registers are used for
  - Local variables?
  - Argument passing?
  - Function call results?
  - Stack Pointer?

# Compiler Register Conventions

Reg No	Name	Used for
0	zero	Always returns 0
1	at	(assembler temporary) Reserved for use by assembler
2-3	v0-v1	Value (except FP) returned by subroutine
4-7	a0-a3	(arguments) First four parameters for a subroutine
8-15	t0-t7	(temporaries) subroutines may use without saving
24-25	t8-t9	
16-23	s0-s7	Subroutine "register variables"; a subroutine which will write one of these must save the old value and restore it before it exits, so the <i>calling</i> routine sees their values preserved.
26-27	k0-k1	Reserved for use by interrupt/trap handler - may change under your feet
28	gp	global pointer - some runtime systems maintain this to give easy access to (some) "static" or "extern" variables.
29	sp	stack pointer
30	s8/fp	9th register variable. Subroutines which need one can use this as a "frame pointer".
31	ra	Return address for subroutine

# Simple factorial

```
int fact(int n)                                0: 1880000b    blez    a0,30 <fact+0x30>
{
  int r = 1;                                   4: 24840001    addiu   a0,a0,1
  int i;                                       8: 24030001    li     v1,1
  for (i = 1; i < n+1; i++) {                c: 24020001    li     v0,1
    r = r * i;                                10: 00430018   mult   v0,v1
  }                                           14: 24630001   addiu   v1,v1,1
  return r;                                  18: 00001012   mflo   v0
}                                           1c: 00000000   nop
                                           20: 1464fffc   bne    v1,a0,14 <fact+0x14>
                                           24: 00430018   mult   v0,v1
                                           28: 03e00008   jr     ra
                                           2c: 00000000   nop
                                           30: 03e00008   jr     ra
                                           34: 24020001   li     v0,1
```

# Function Stack Frames

- Each function call allocates a new stack frame for local variables, the return address, previous frame pointer etc.
  - Frame pointer: start of current stack frame
  - Stack pointer: end of current stack frame
- Example: assume f1() calls f2(), which calls f3().

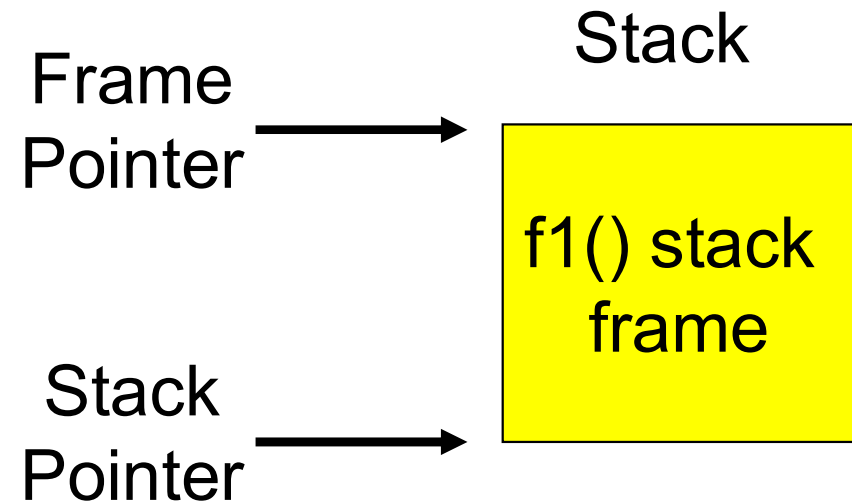

# Function Stack Frames

- Each function call allocates a new stack frame for local variables, the return address, previous frame pointer etc.
  - Frame pointer: start of current stack frame
  - Stack pointer: end of current stack frame
- Example: assume f1() calls f2(), which calls f3().

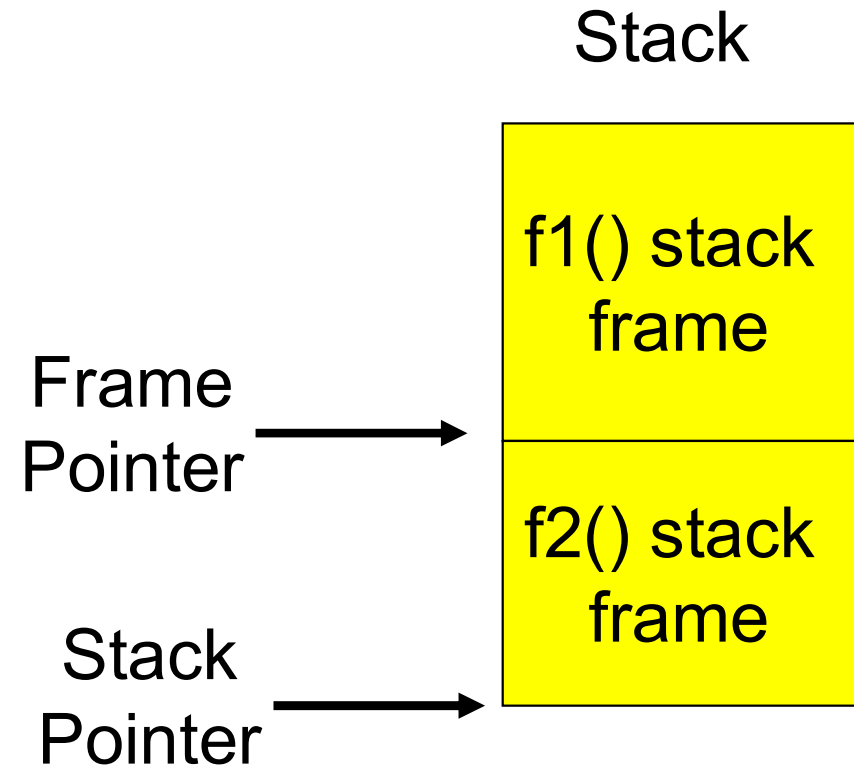

# Function Stack Frames

- Each function call allocates a new stack frame for local variables, the return address, previous frame pointer etc.
  - Frame pointer: start of current stack frame
  - Stack pointer: end of current stack frame
- Example: assume f1() calls f2(), which calls f3().

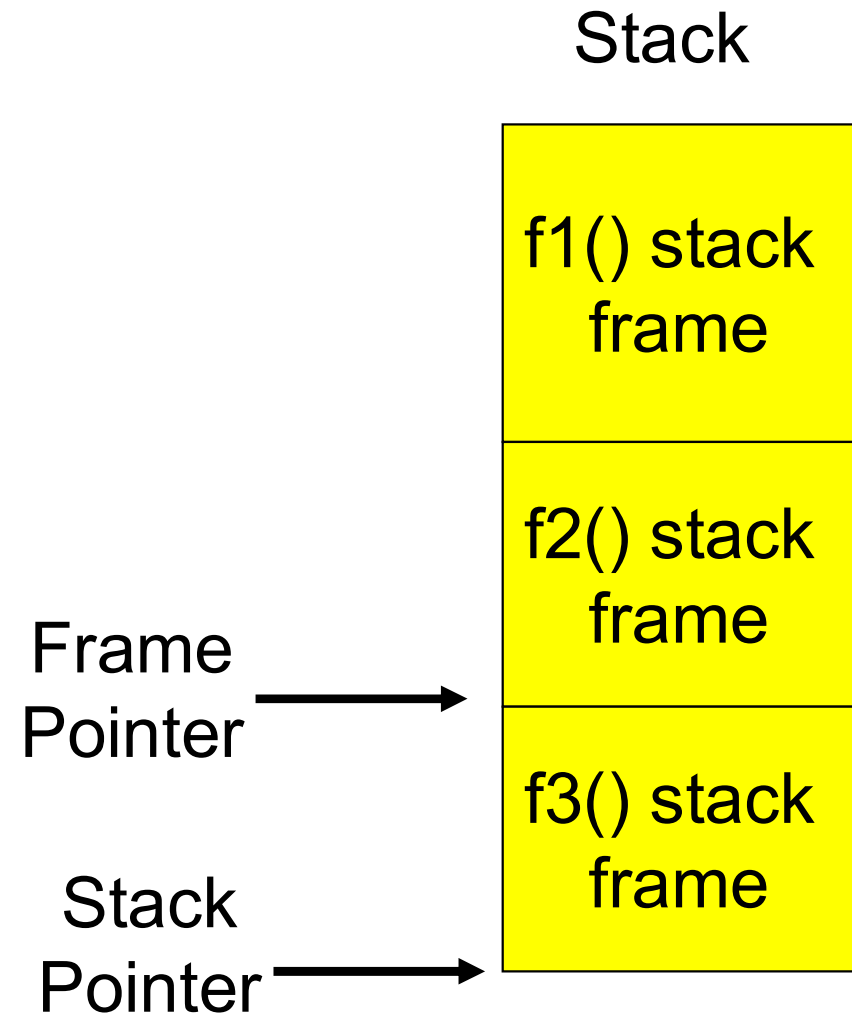



# Stack Frame

- MIPS calling convention for gcc
  - Args 1-4 have space reserved for them

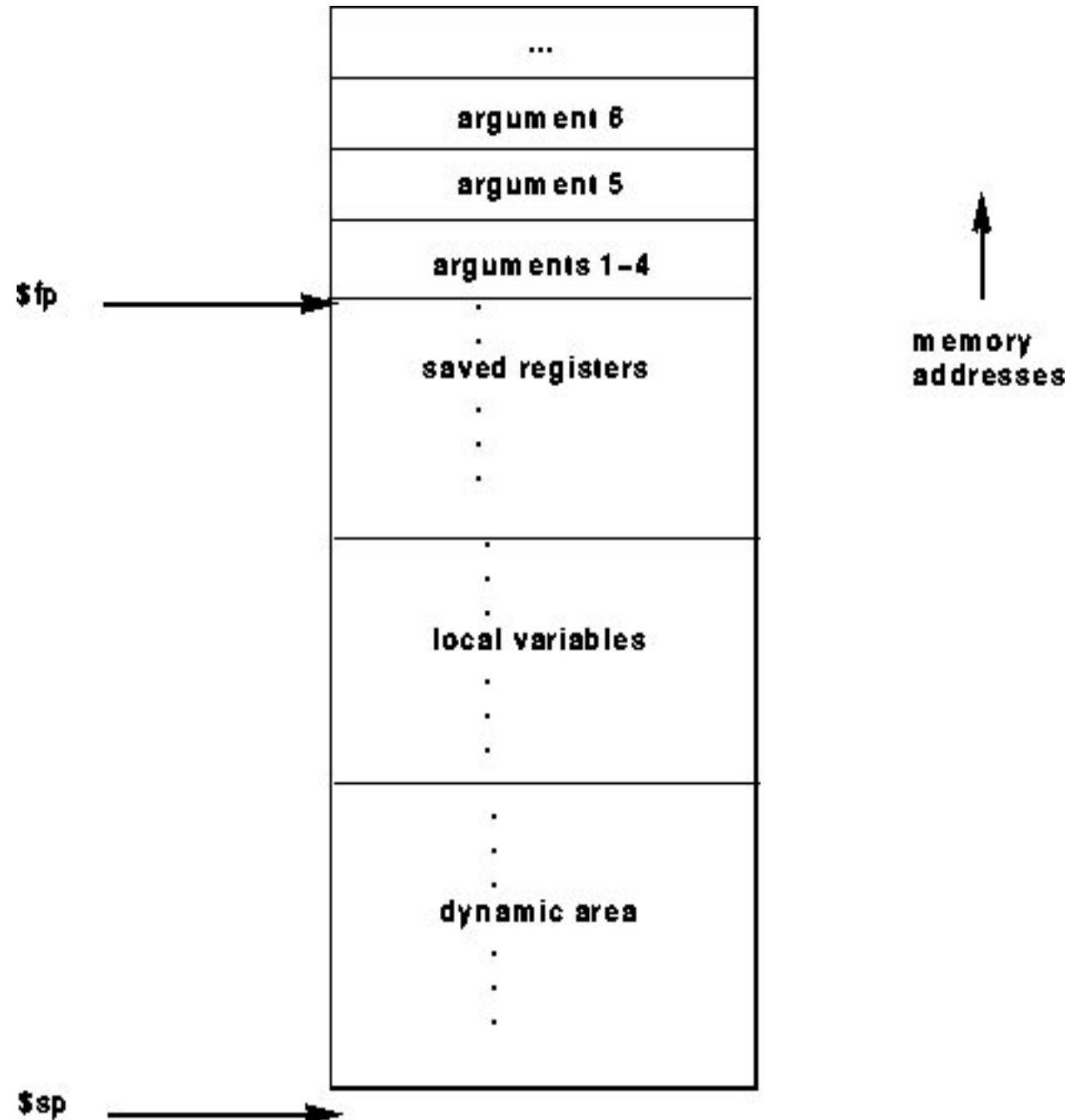

# Example Code

```
main ()
{
    int i;

    i =
    sixargs (1,2,3,4,5,6);
}
```

```
int sixargs(int a, int
            b, int c, int d, int e,
            int f)
{
    return a + b + c + d
           + e + f;
}
```

0040011c <main>:

```
40011c:    27bdf fd8      addiu  sp, sp, -40
400120:    afbf0024     sw    ra, 36(sp)
400124:    afbe0020     sw    s8, 32(sp)
400128:    03a0f021     move  s8, sp
40012c:    24020005     li    v0, 5
400130:    afa20010     sw    v0, 16(sp)
400134:    24020006     li    v0, 6
400138:    afa20014     sw    v0, 20(sp)
40013c:    24040001     li    a0, 1
400140:    24050002     li    a1, 2
400144:    24060003     li    a2, 3
400148:    0c10002c     jal   4000b0 <sixargs>
40014c:    24070004     li    a3, 4
400150:    afc20018     sw    v0, 24(s8)
400154:    03c0e821     move  sp, s8
400158:    8fbf0024     lw    ra, 36(sp)
40015c:    8fbe0020     lw    s8, 32(sp)
400160:    03e00008     jr    ra
400164:    27bd0028     addiu sp, sp, 40
```

...

004000b0 <sixargs>:

4000b0:	27bdfff8	addiu	sp, sp, -8
4000b4:	afbe0000	sw	s8, 0 (sp)
4000b8:	03a0f021	move	s8, sp
4000bc:	afc40008	sw	a0, 8 (s8)
4000c0:	afc5000c	sw	a1, 12 (s8)
4000c4:	afc60010	sw	a2, 16 (s8)
4000c8:	afc70014	sw	a3, 20 (s8)
4000cc:	8fc30008	lw	v1, 8 (s8)
4000d0:	8fc2000c	lw	v0, 12 (s8)
4000d4:	00000000	nop	
4000d8:	00621021	addu	v0, v1, v0
4000dc:	8fc30010	lw	v1, 16 (s8)
4000e0:	00000000	nop	
4000e4:	00431021	addu	v0, v0, v1
4000e8:	8fc30014	lw	v1, 20 (s8)
4000ec:	00000000	nop	
4000f0:	00431021	addu	v0, v0, v1
4000f4:	8fc30018	lw	v1, 24 (s8)
4000f8:	00000000	nop	

```
4000fc: 00431021  addu v0 ,v0 ,v1
400100: 8fc3001c  lw    v1 ,28 (s8)
400104: 00000000  nop
400108: 00431021  addu v0 ,v0 ,v1
40010c: 03c0e821  move sp ,s8
400110: 8fbe0000  lw    s8 ,0 (sp)
400114: 03e00008  jr    ra
400118: 27bd0008  addi sp ,sp ,8
```

# The Process Model

- Multiprogramming of four programs

One program counter

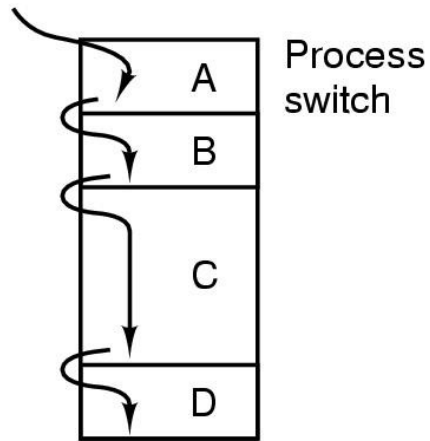

(a)

Four program counters

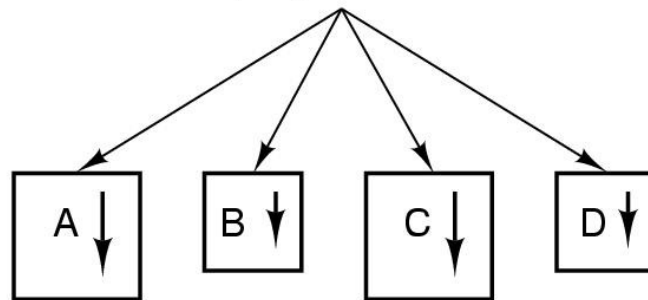

(b)

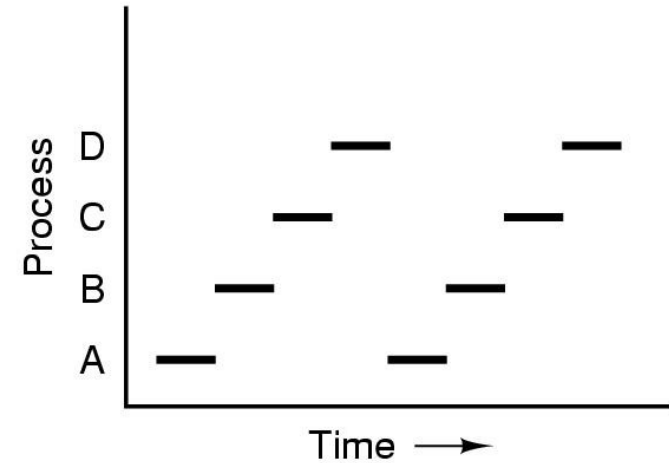

(c)

# Process

- Minimally consist of three segments
  - Text
    - contains the code (instructions)
  - Data
    - Global variables
  - Stack
    - Activation records of procedure/function/method
    - Local variables
- Note:
  - data can dynamically grow up
    - E.g., malloc()-ing
  - The stack can dynamically grow down
    - E.g., increasing function call depth or recursion

# Process Memory Layout

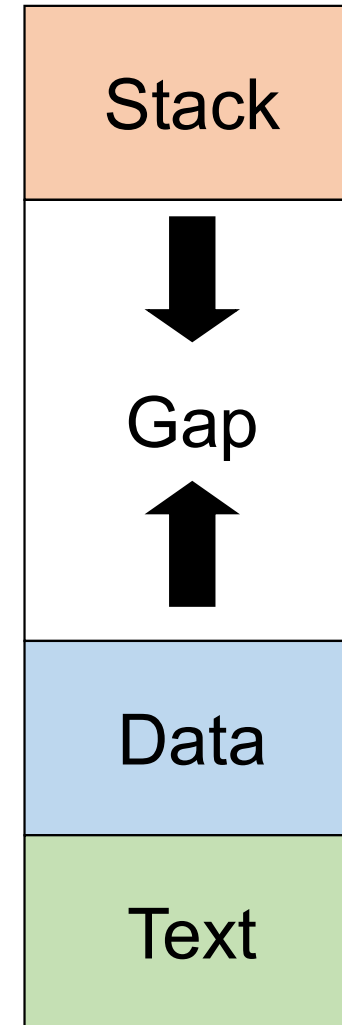

# Processes

Process's user-level stack and execution state

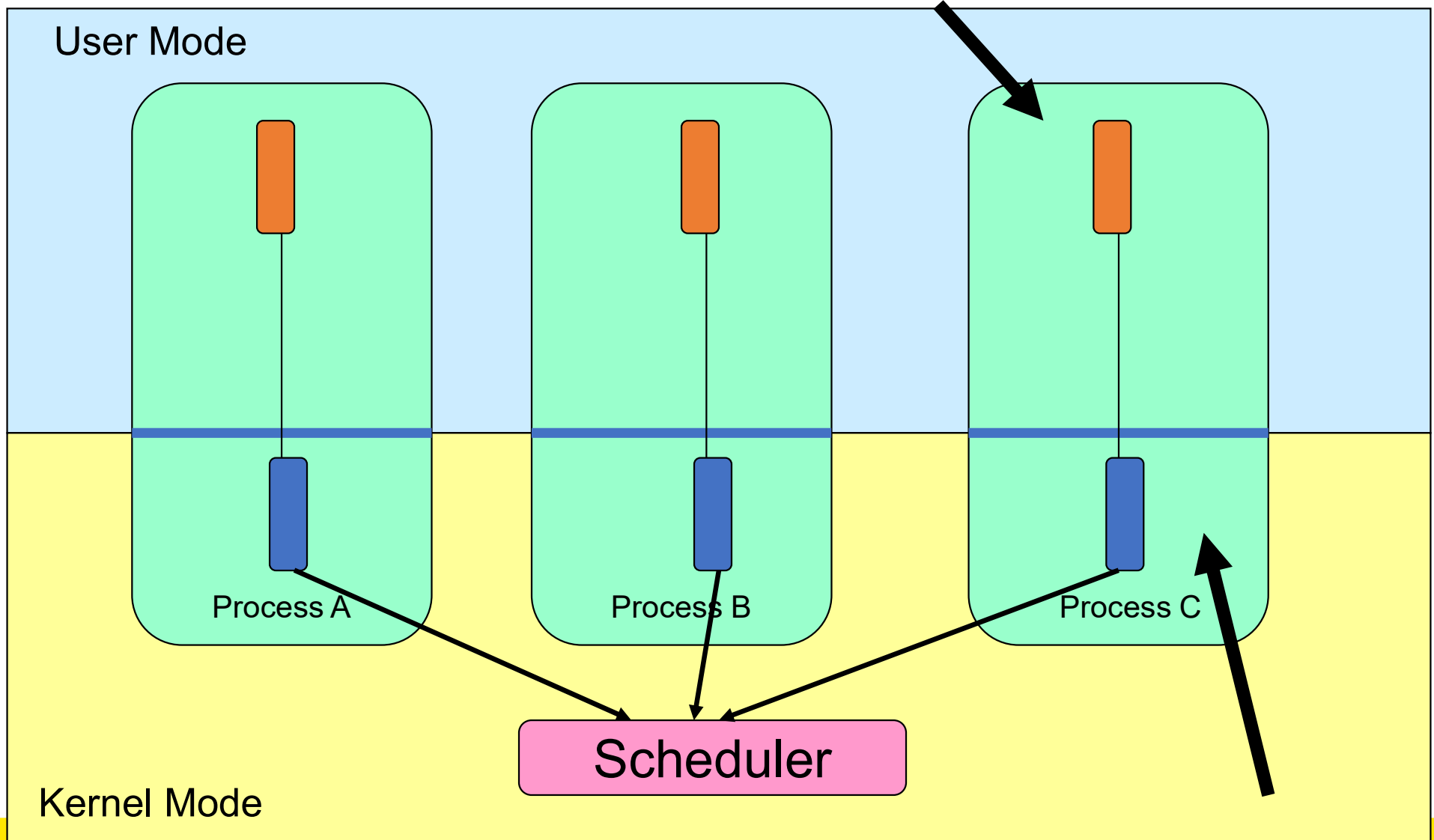

Process's in-kernel stack and execution state



# Processes

- User-mode
  - Processes (programs) scheduled by the kernel
  - Isolated from each other
  - No concurrency issues between each other
- System-calls transition into and return from the kernel
- Kernel-mode
  - Nearly all activities still associated with a process
  - Kernel memory shared between all processes
  - Concurrency issues exist between processes concurrently executing in a system call

# Threads

## The Thread Model

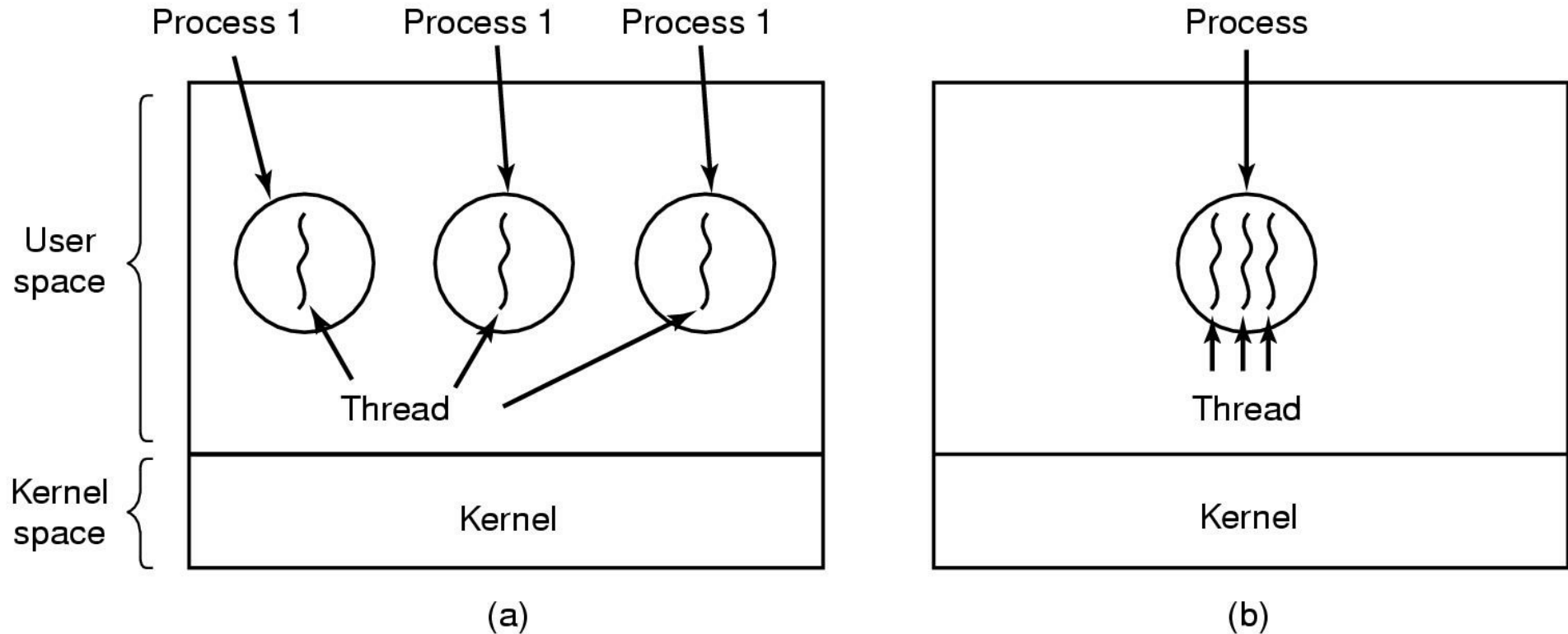

- (a) Three processes each with one thread
- (b) One process with three threads

# The Thread Model

<b>Per process items</b>	<b>Per thread items</b>
Address space	Program counter
Global variables	Registers
Open files	Stack
Child processes	State
Pending alarms	
Signals and signal handlers	
Accounting information	

- Items shared by all threads in a process
- Items that exist per thread

# The Thread Model

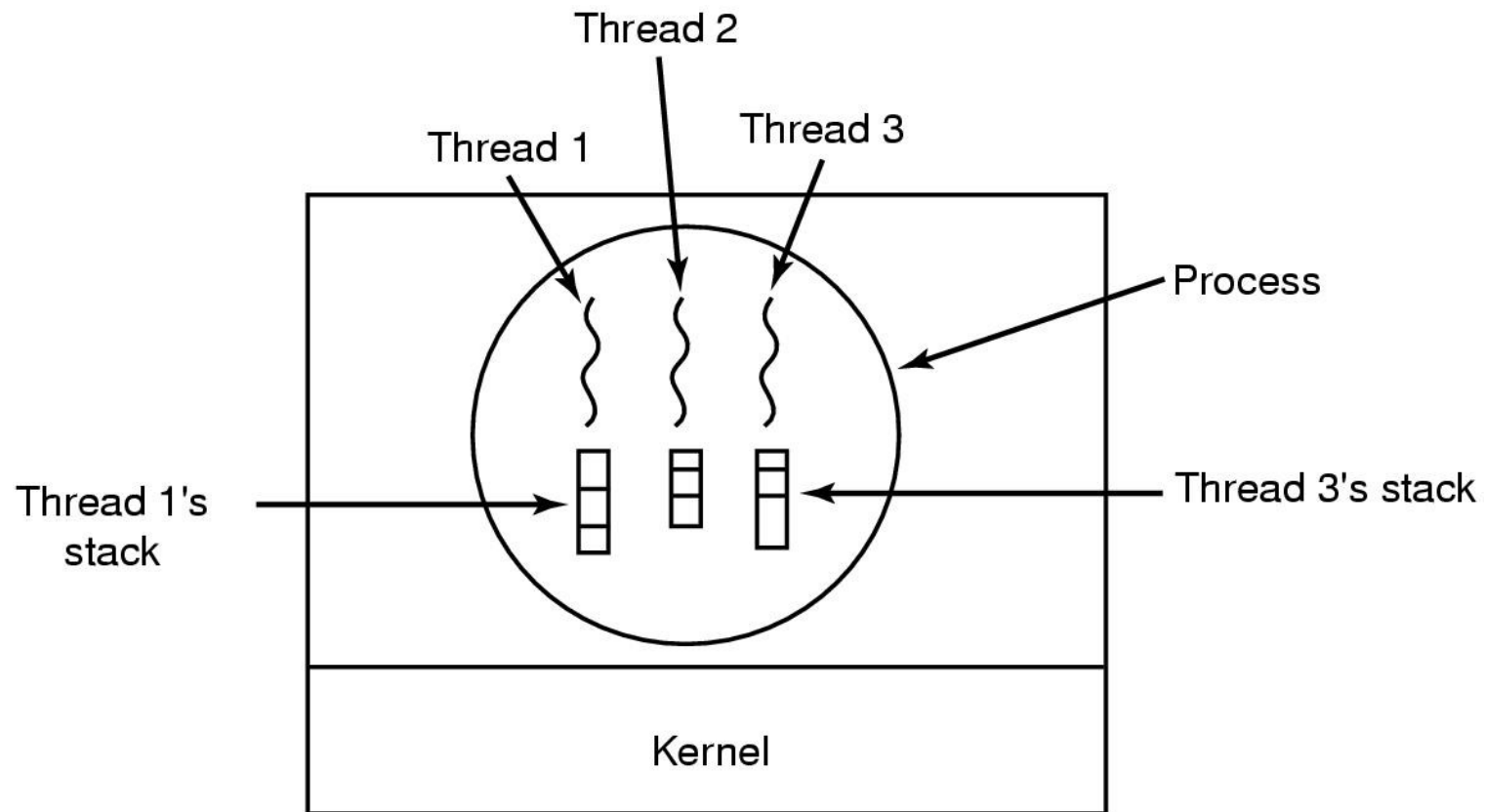

Each thread has its own stack

# A Subset of POSIX threads API

```
int  pthread_create(pthread_t *, const pthread_attr_t *,
                   void *(*)(void *), void *);
```

```
void pthread_exit(void *);
```

```
int  pthread_mutex_init(pthread_mutex_t *, const pthread_mutexattr_t *);
```

```
int  pthread_mutex_destroy(pthread_mutex_t *);
```

```
int  pthread_mutex_lock(pthread_mutex_t *);
```

```
int  pthread_mutex_unlock(pthread_mutex_t *);
```

```
int  pthread_rwlock_init(pthread_rwlock_t *,
                        const pthread_rwlockattr_t *);
```

```
int  pthread_rwlock_destroy(pthread_rwlock_t *);
```

```
int  pthread_rwlock_rdlock(pthread_rwlock_t *);
```

```
int  pthread_rwlock_wrlock(pthread_rwlock_t *);
```

```
int  pthread_rwlock_unlock(pthread_rwlock_t *);
```

# Where to Implement Application

## Threads?

Note: Thread API similar in both cases

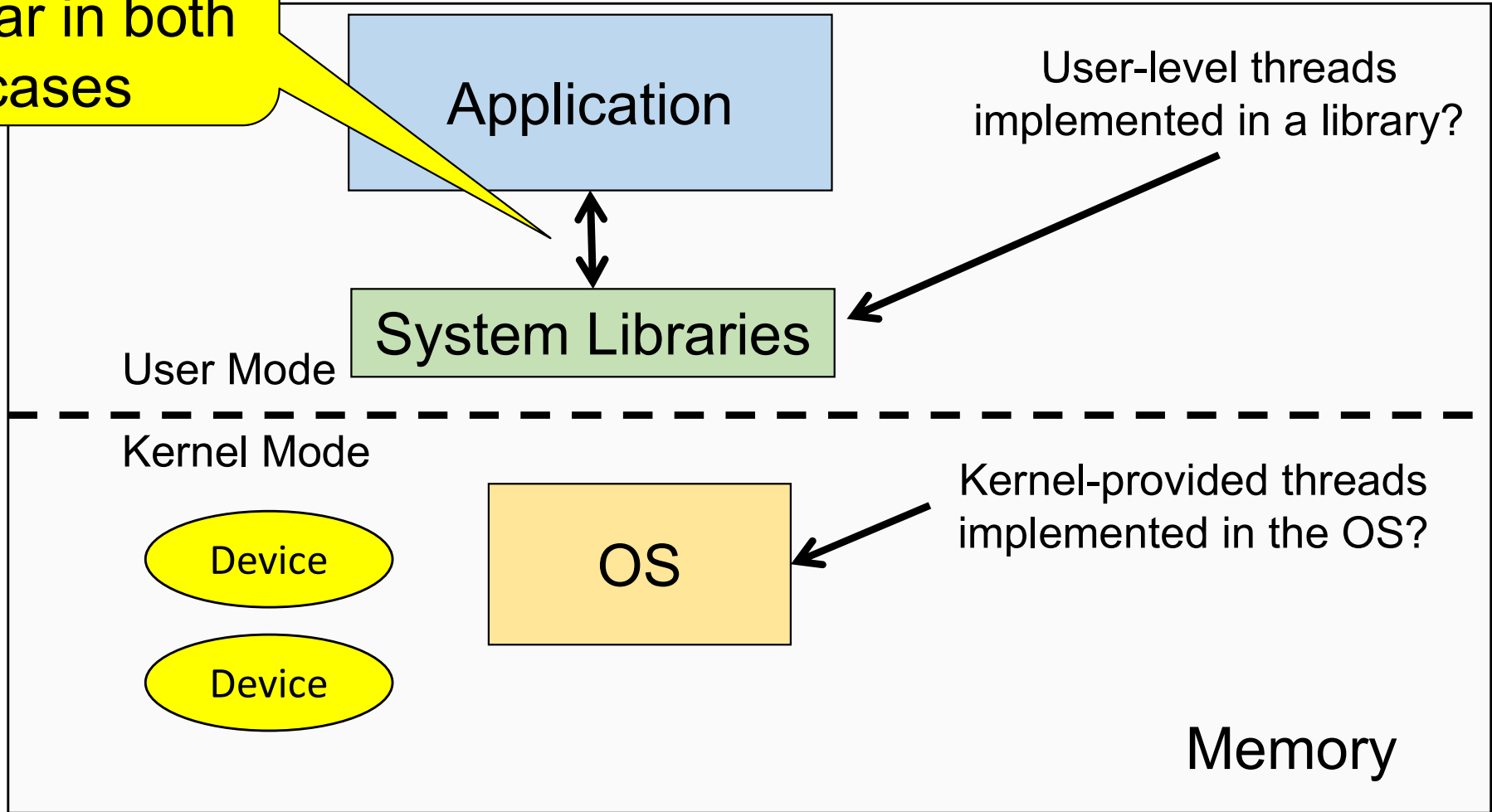

# Implementing Threads in User Space

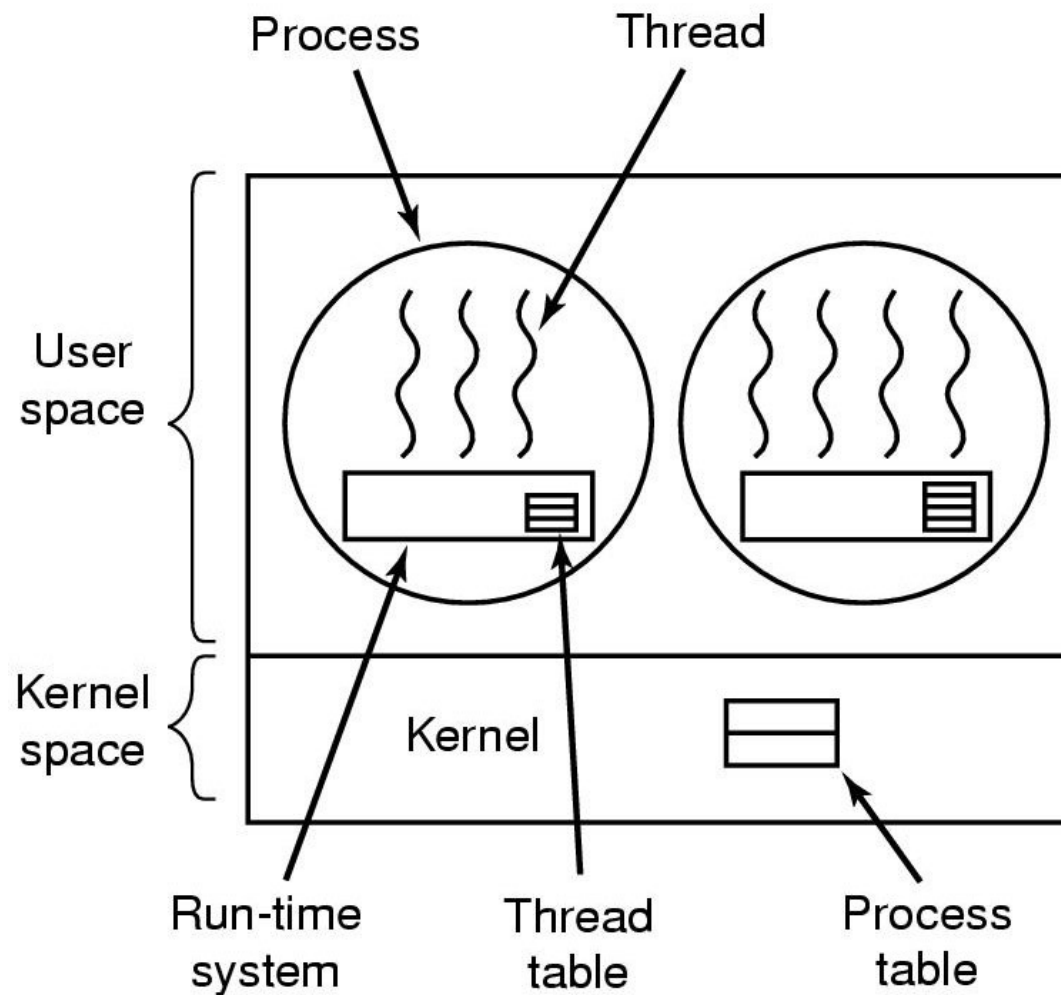

A user-level threads library

# User-level Threads

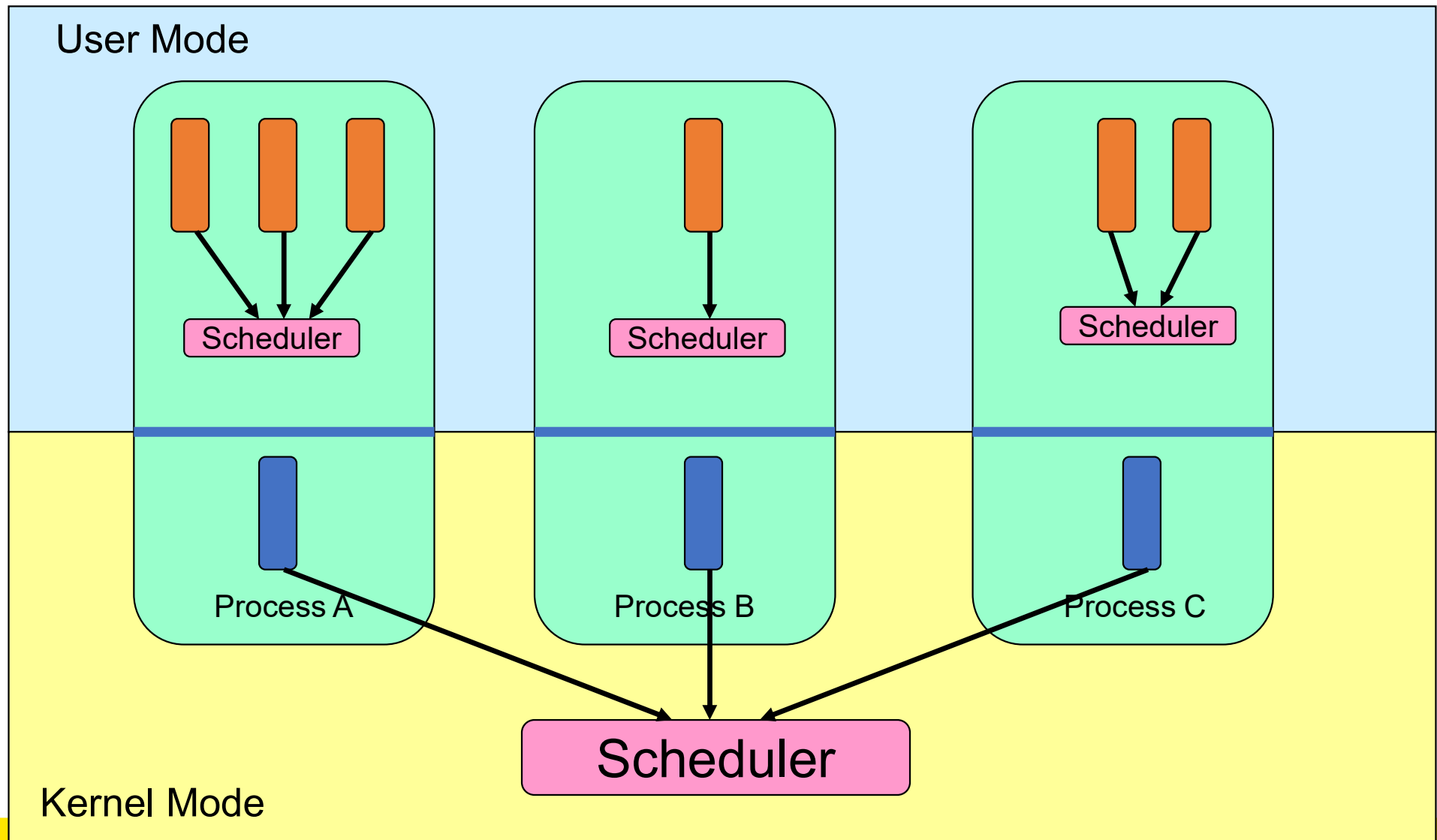



# User-level Threads

- Implementation at user-level
  - User-level Thread Control Block (TCB), ready queue, blocked queue, and dispatcher
  - Kernel has no knowledge of the threads (it only sees a single process)
  - If a thread blocks waiting for a resource held by another thread inside the same process, its state is saved and the dispatcher switches to another ready thread
  - Thread management (create, exit, yield, wait) are implemented in a runtime support library

# User-Level Threads

- Pros

- Thread management and switching at user level is much faster than doing it in kernel level
  - No need to trap (take syscall exception) into kernel and back to switch
- Dispatcher algorithm can be tuned to the application
  - E.g. use priorities
- Can be implemented on any OS (thread or non-thread aware)
- Can easily support massive numbers of threads on a per-application basis
  - Use normal application virtual memory
  - Kernel memory more constrained. Difficult to efficiently support wildly differing numbers of threads for different applications.

# User-level Threads

- Cons

- Threads have to yield() manually (no timer interrupt delivery to user-level)
  - **Co-operative multithreading**
    - A single poorly design/implemented thread can monopolise the available CPU time
    - There are work-arounds (e.g. a timer signal per second to enable pre-emptive multithreading), they are coarse grain and a kludge.
- Does not take advantage of multiple CPUs (in reality, we still have a single threaded process as far as the kernel is concerned)

# User-Level Threads

- Cons

- If a thread makes a blocking system call (or takes a page fault), the process (and all the internal threads) blocks
  - Can't overlap I/O with computation

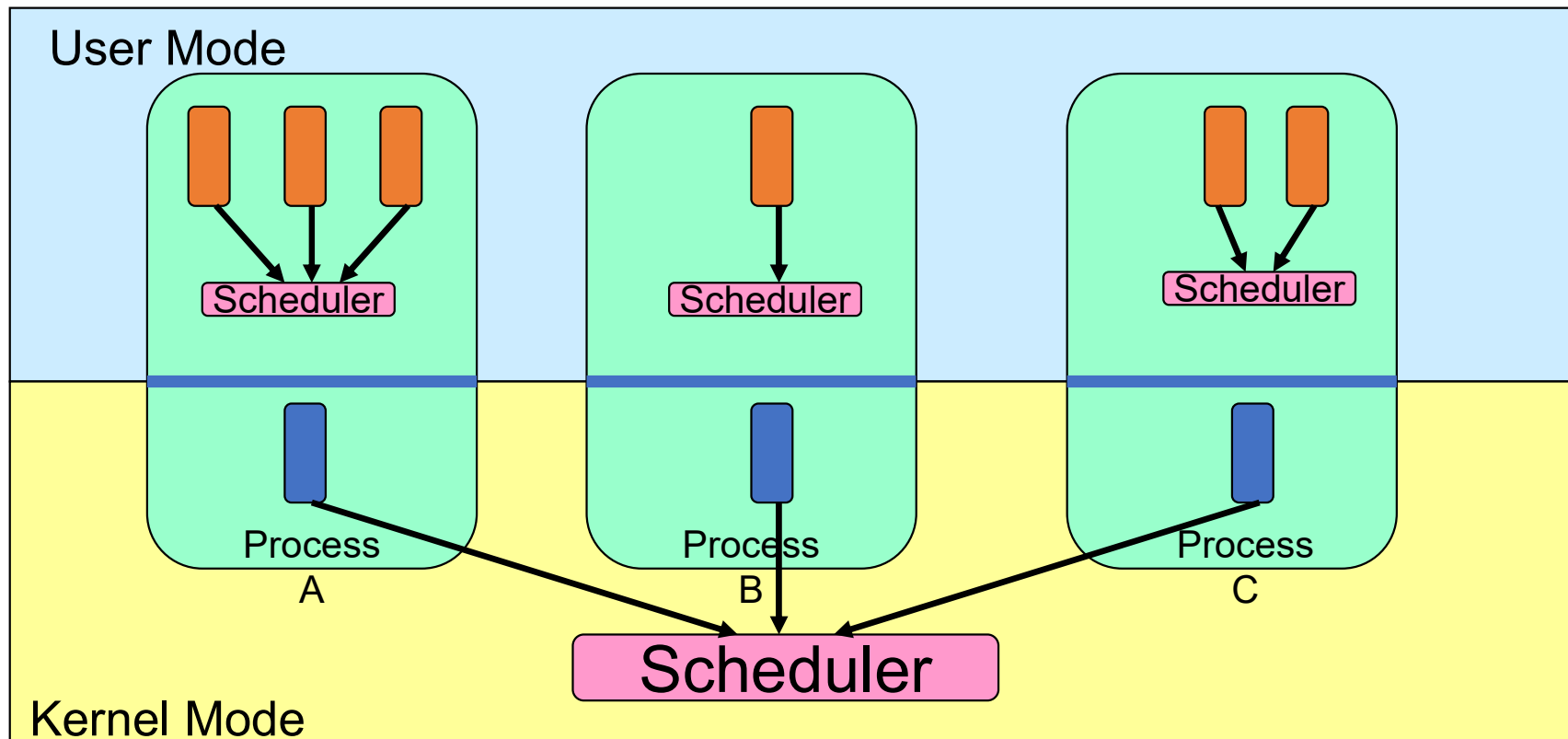

# Implementing Threads in the Kernel

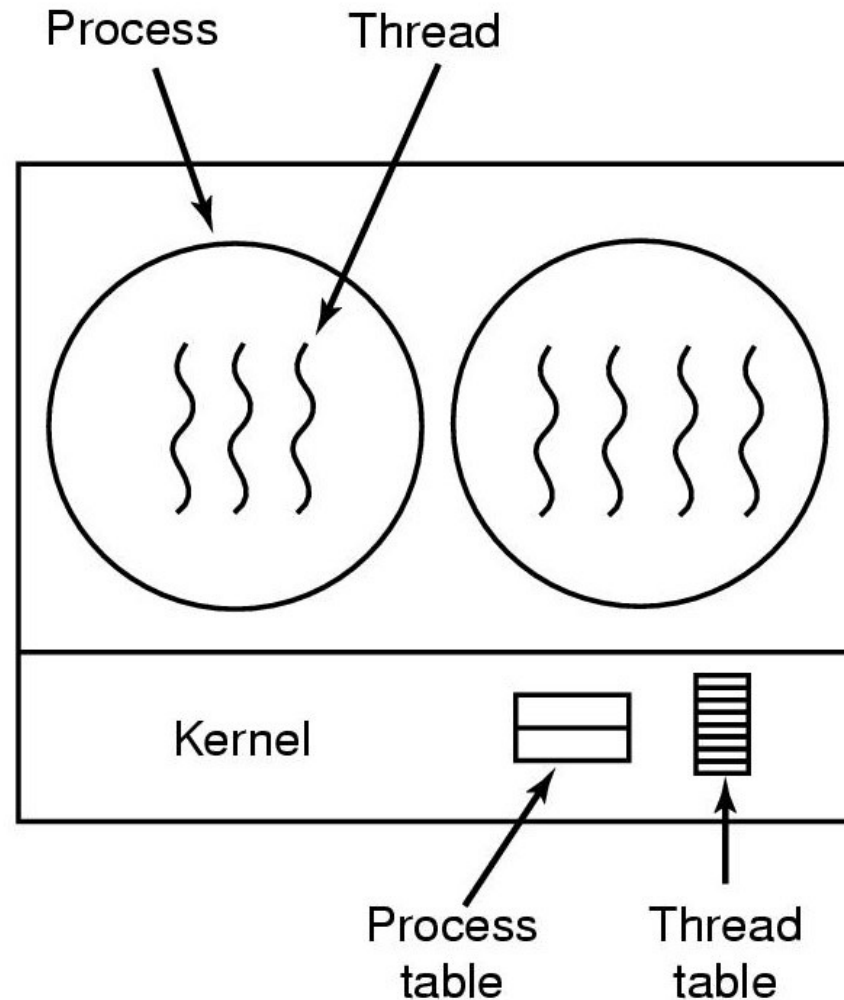

A threads package managed by the kernel

# Kernel-provided Threads

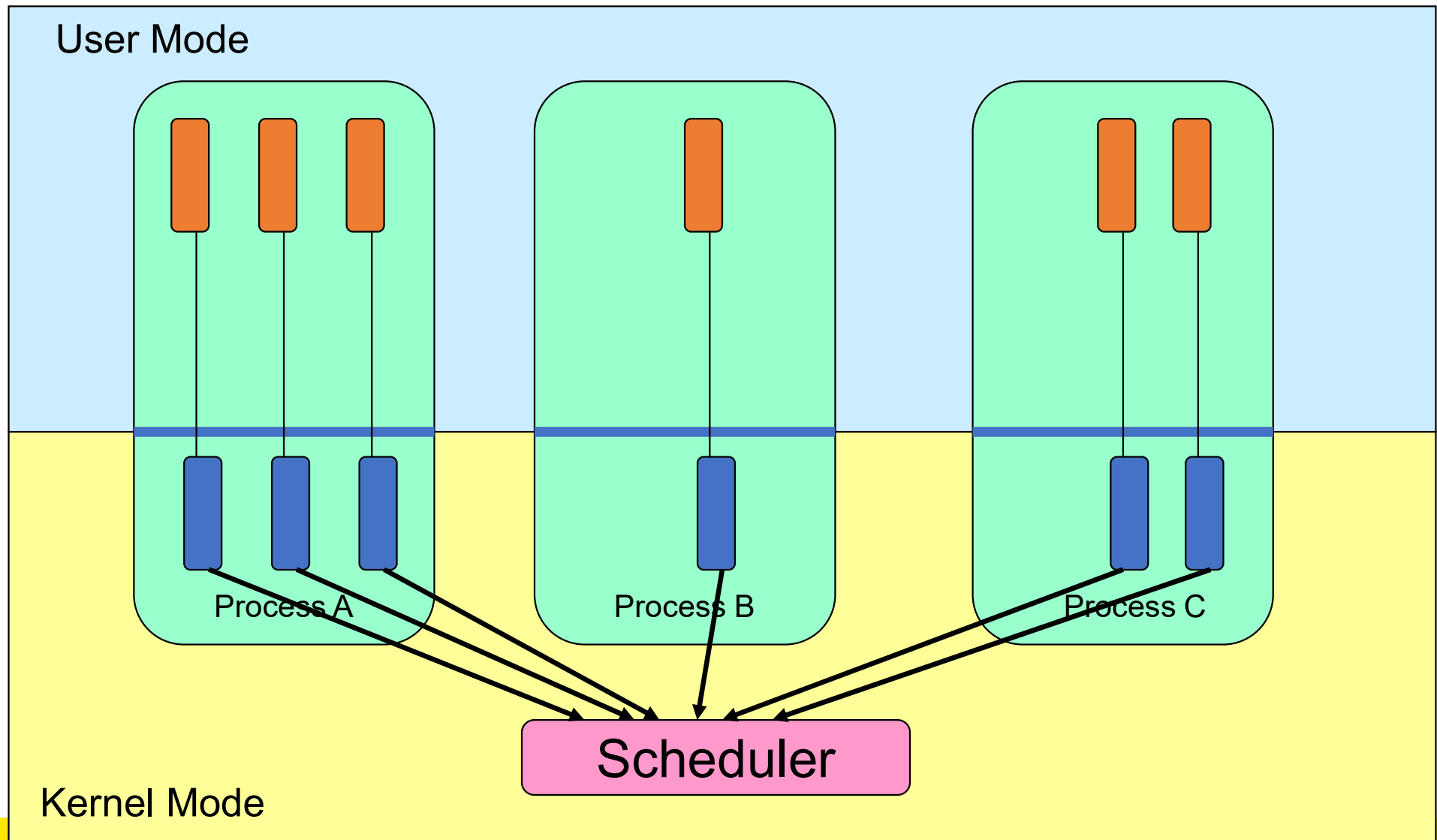

# Kernel-provided Threads

- Also called kernel-level threads
  - Even though they provide threads to applications
- Threads are implemented by the kernel
  - TCBs are stored in the kernel
    - A subset of information in a traditional PCB
      - The subset related to execution context
    - TCBs have a PCB associated with them
      - Resources associated with the group of threads (the process)
  - Thread management calls are implemented as system calls
    - E.g. create, wait, exit

# Kernel-provided Threads

- Cons
  - Thread creation and destruction, and blocking and unblocking threads requires kernel entry and exit.
    - More expensive than user-level equivalent



# Kernel-provided Threads

- Pros
  - **Preemptive** multithreading
  - Parallelism
    - Can overlap blocking I/O with computation
    - Can take advantage of a multiprocessor

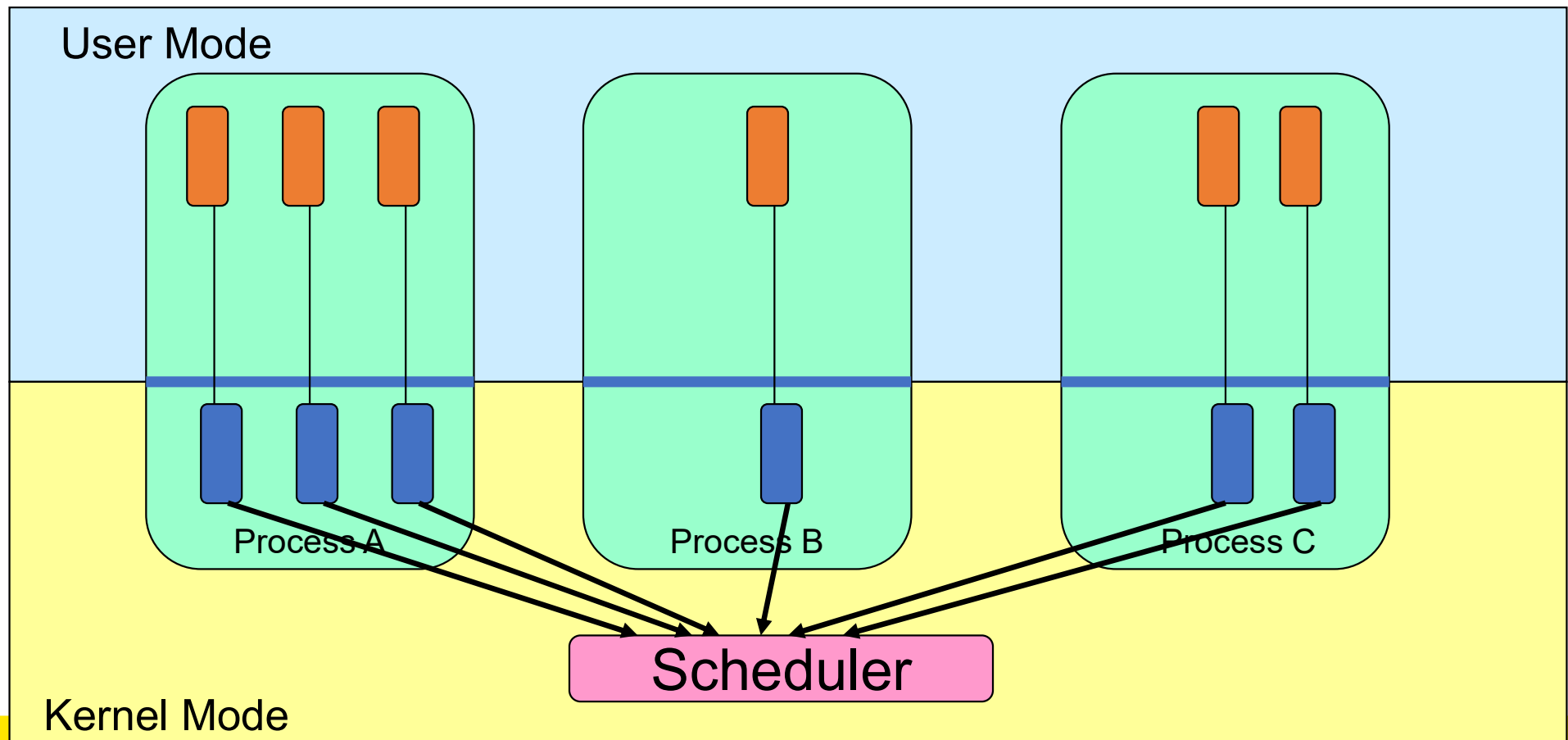

# Multiprogramming Implementation

1. Hardware stacks program counter, etc.
2. Hardware loads new program counter from interrupt vector.
3. Assembly language procedure saves registers.
4. Assembly language procedure sets up new stack.
5. C interrupt service runs (typically reads and buffers input).
6. Scheduler decides which process is to run next.
7. C procedure returns to the assembly code.
8. Assembly language procedure starts up new current process.

Skeleton of what lowest level of OS does when an interrupt occurs – a context switch

# *Context Switch* Terminology

- A context switch can refer to
  - A switch between threads
    - Involving saving and restoring of state associated with a thread
  - A switch between processes
    - Involving the above, plus extra state associated with a process.
      - E.g. memory maps

# Context Switch Occurrence

- A switch between process/threads can happen any time the OS is invoked
  - On a system call
    - Mandatory if system call blocks or on `exit()`;
  - On an exception
    - Mandatory if offender is killed
  - On an interrupt
    - Triggering a dispatch is the main purpose of the *timer interrupt*

A thread switch can happen between any two instructions

Note instructions do not equal program statements

# Context Switch

- Context switch must be *transparent* for processes/threads
  - When dispatched again, process/thread should not notice that something else was running in the meantime (except for elapsed time)

⇒ OS must save all state that affects the thread

- This state is called the *process/thread context*
- Switching between process/threads consequently results in a *context switch*.

# Simplified Explicit Thread Switch

# Assume Kernel-Level Threads

Lets focus on user->kernel – switch – kernel -> user

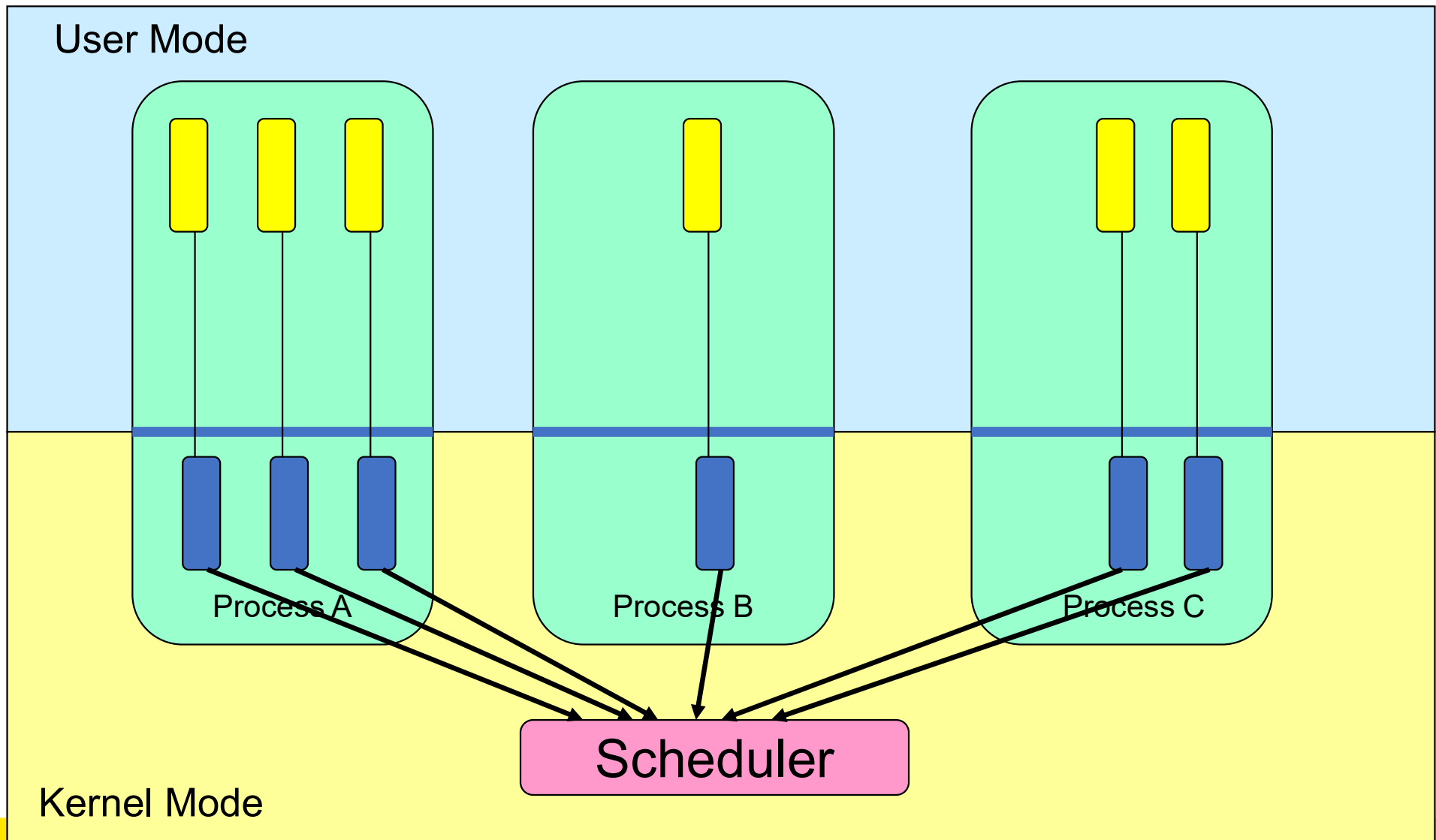

# Example Context Switch

- Running in user mode, SP points to user-level stack (not shown on slide)

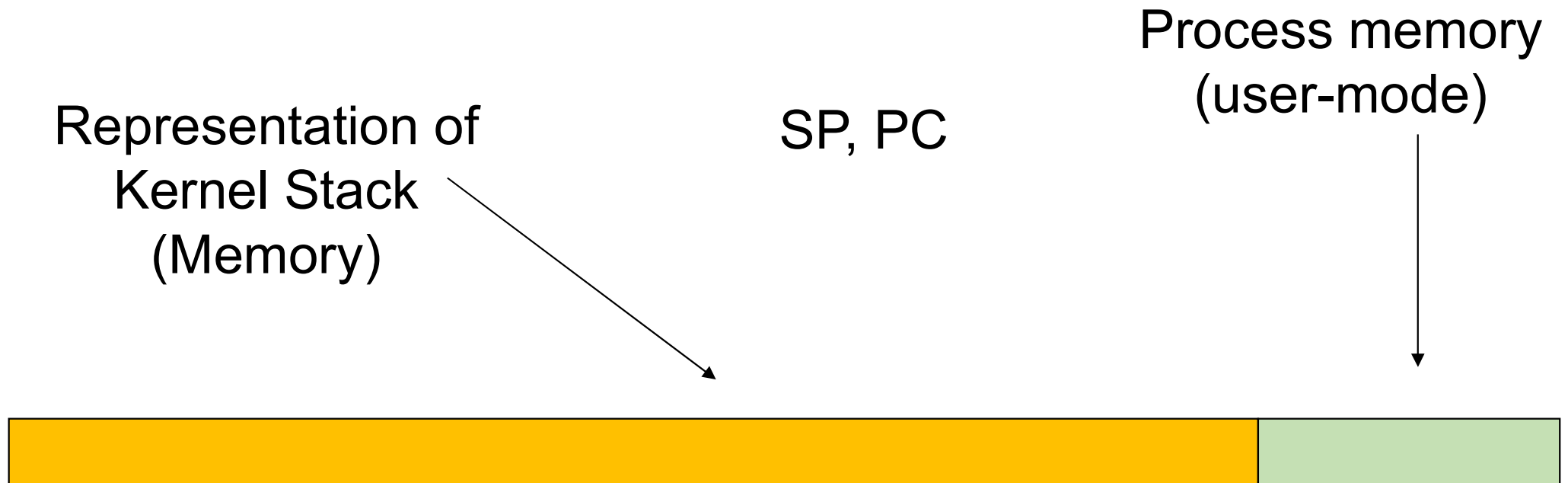



# Example Context Switch

- Take an exception, syscall, or interrupt, and we switch to the kernel stack



# Example Context Switch

- We push a *trapframe* on the stack
  - Also called *exception frame, user-level context....*
  - Includes the user-level PC and SP

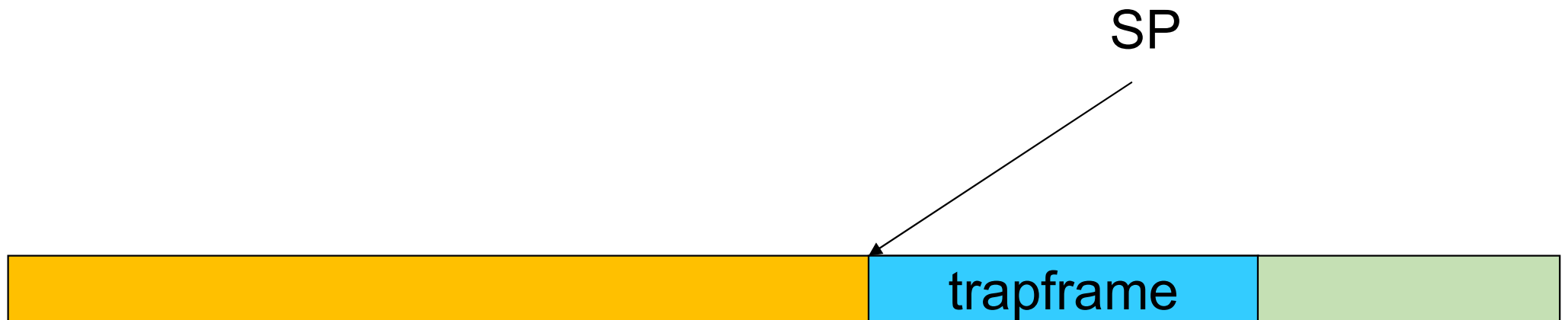

# Example Context Switch

- Call 'C' code to process syscall, exception, or interrupt
  - Results in a 'C' activation stack building up

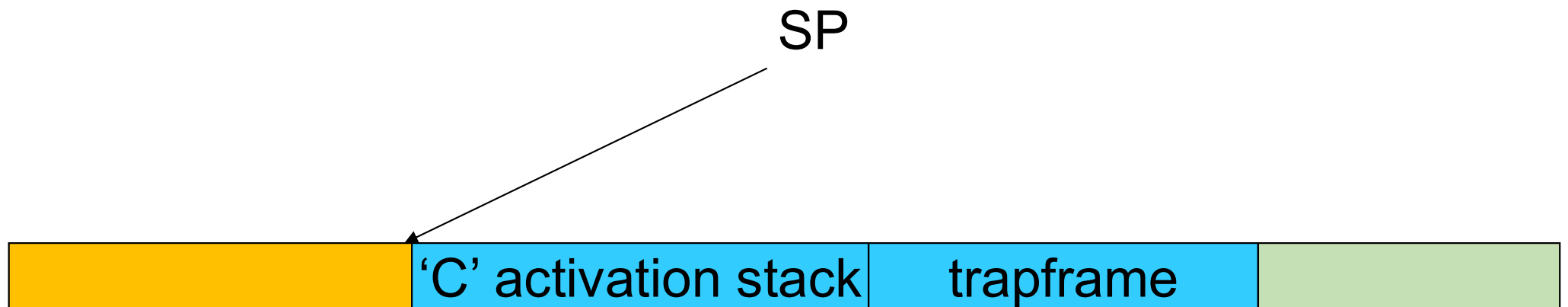

# Example Context Switch

- The kernel decides to perform a context switch
  - It chooses a target thread (or process)
  - It pushes remaining kernel context onto the stack

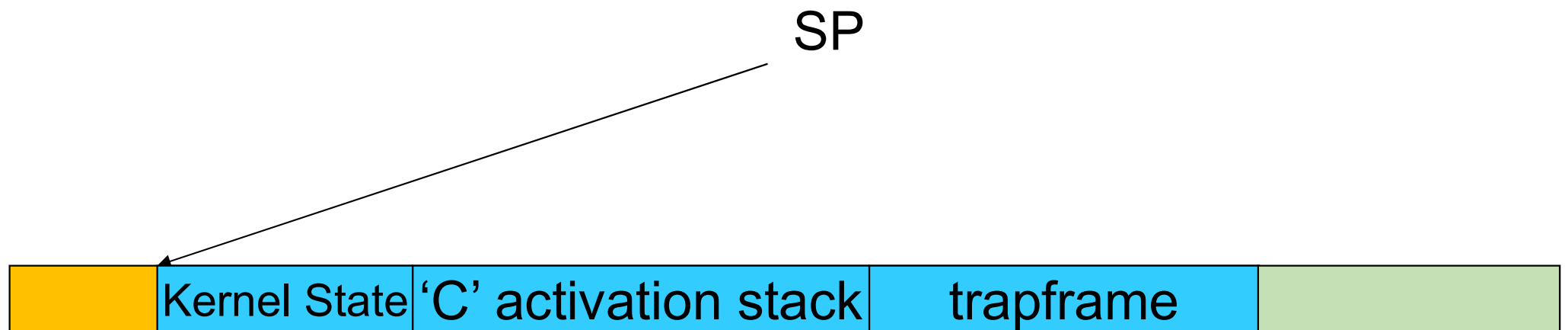

# Example Context Switch

- Any other existing thread must
  - be in kernel mode (on a uni processor),
  - and have a similar stack layout to the stack we are currently using

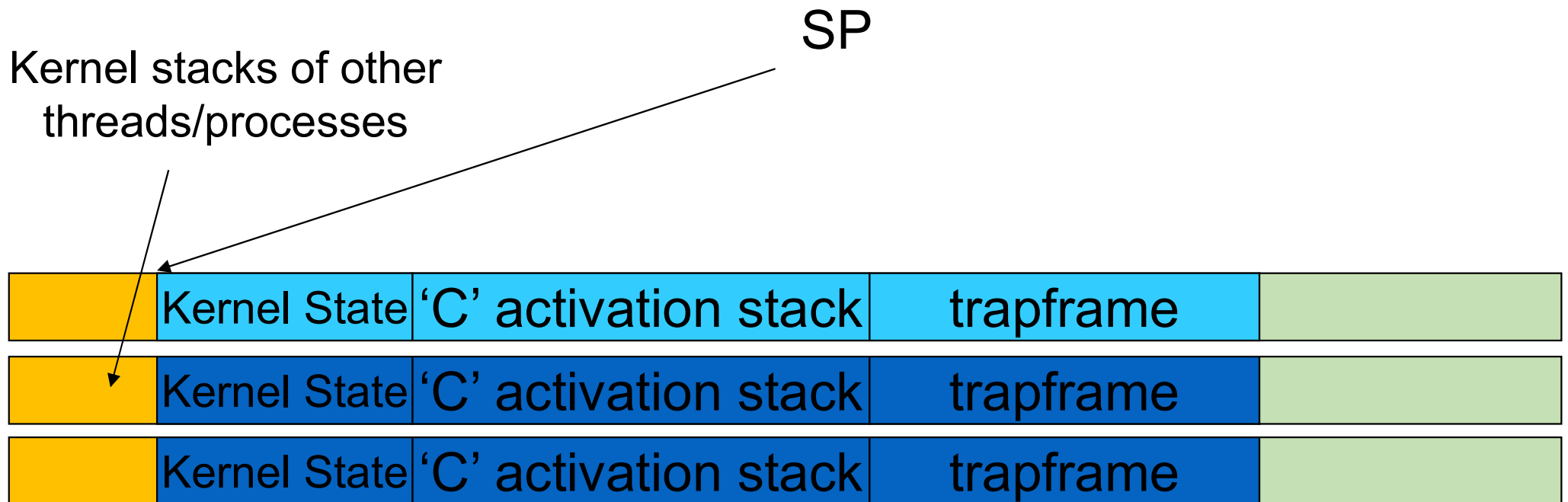

# Example Context Switch

- We save the current SP in the PCB (or TCB), and load the SP of the target thread.
  - Thus we have *switched contexts*

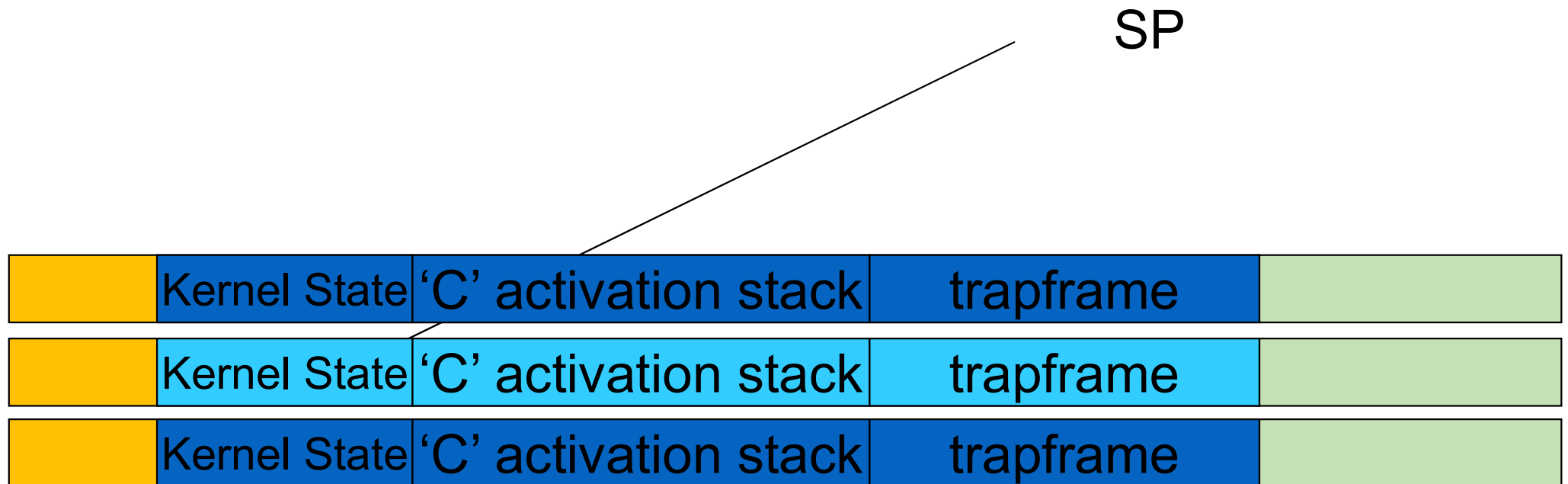

# Example Context Switch

- Load the target thread's previous context, and return to C

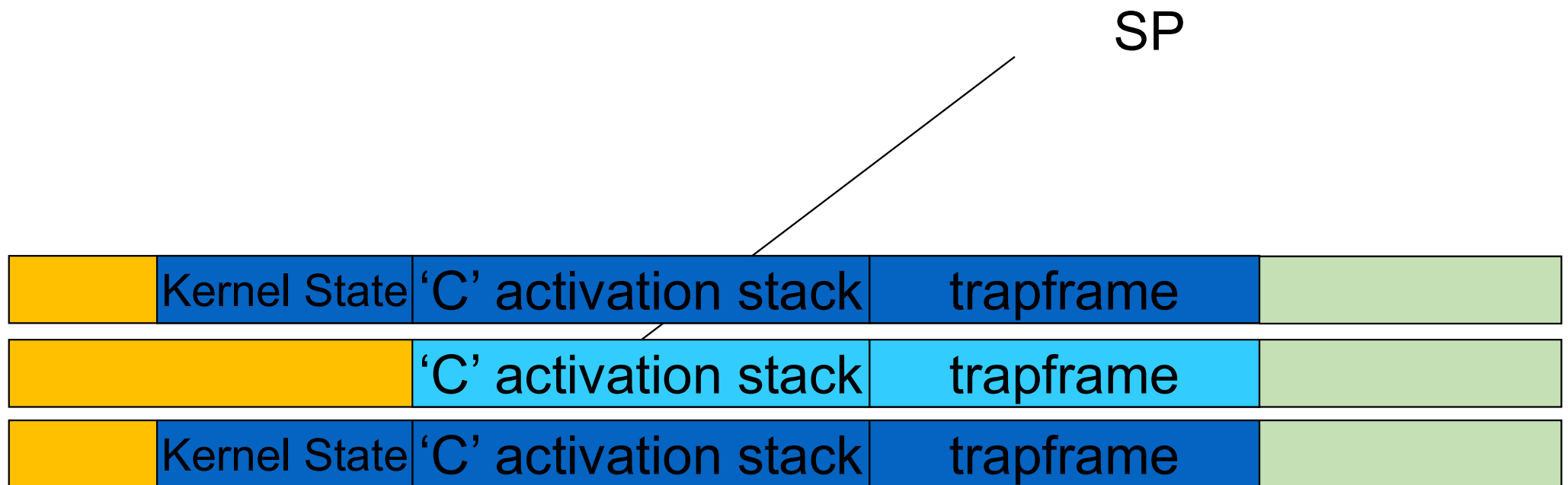

# Example Context Switch

- The C continues and (in this example) returns to user mode.

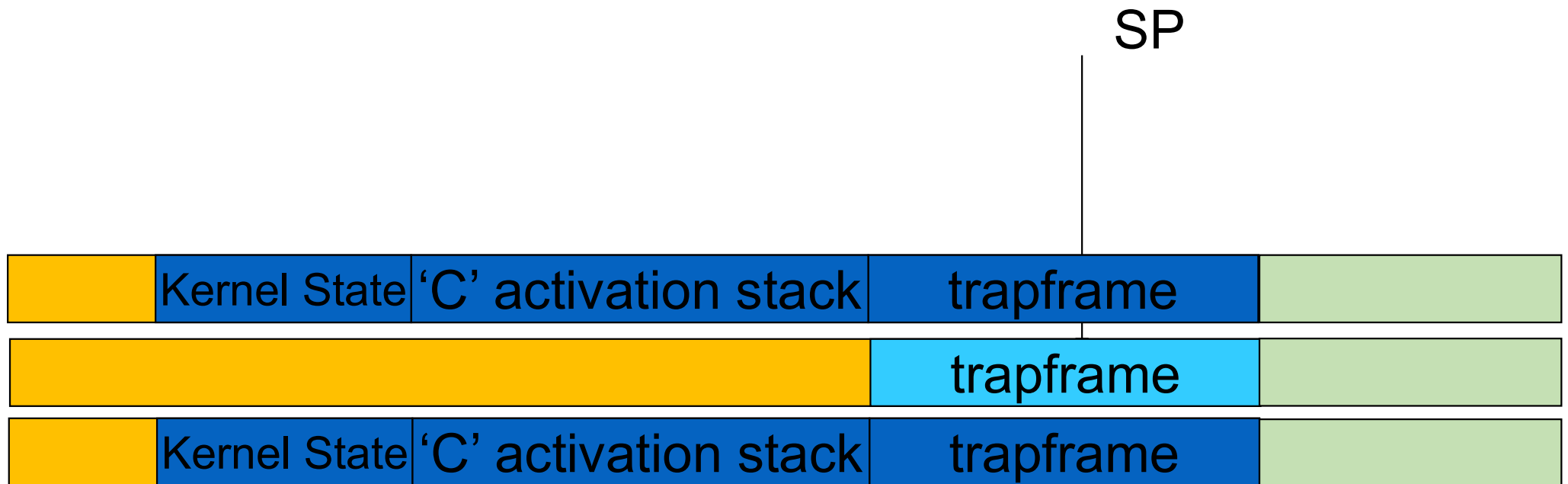



# Example Context Switch

- The user-level context is restored
  - The registers load with that processes previous content

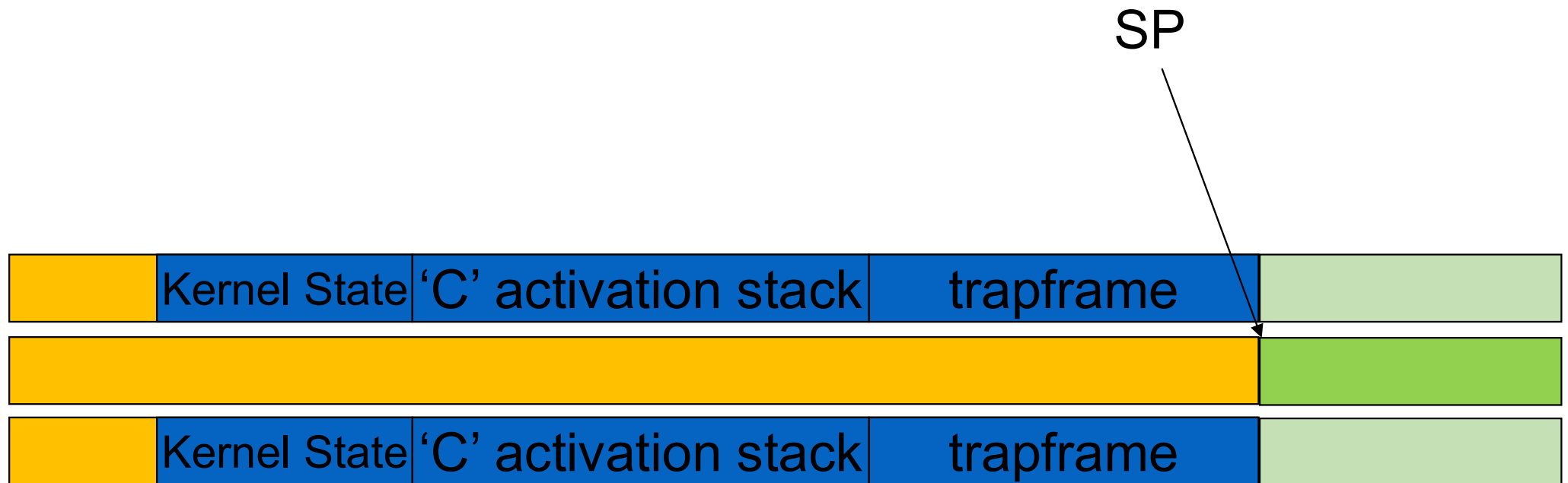

# Example Context Switch

- The user-level SP and PC is restored

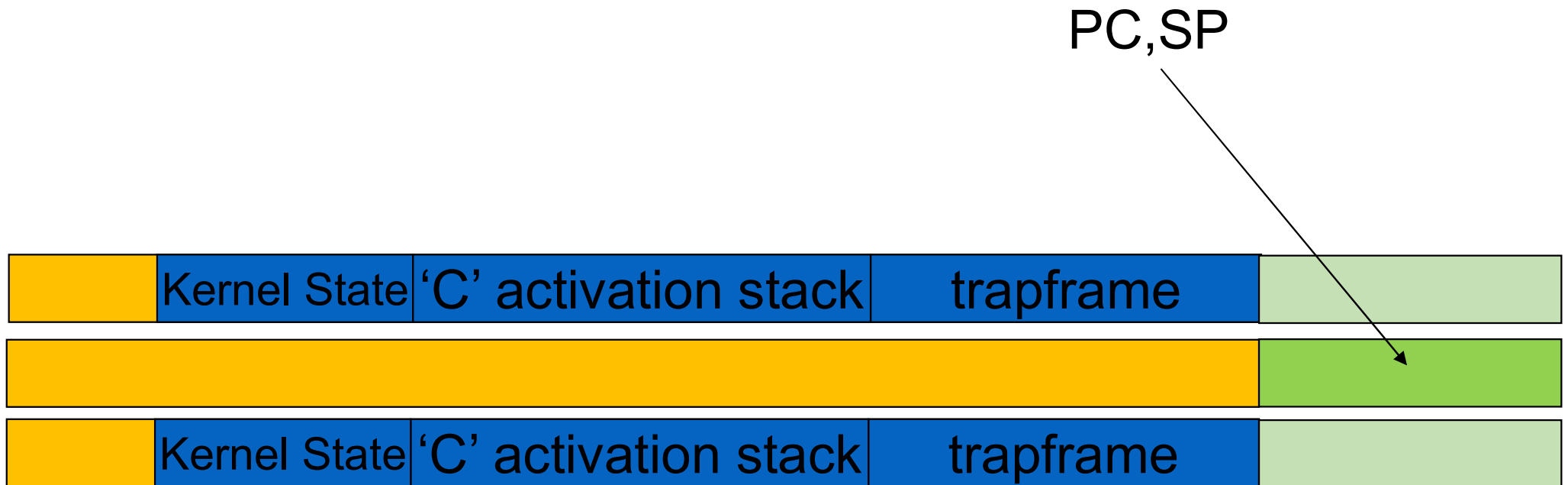

# The Interesting Part of a Thread Switch

- What does the “push kernel state” part do???

SP

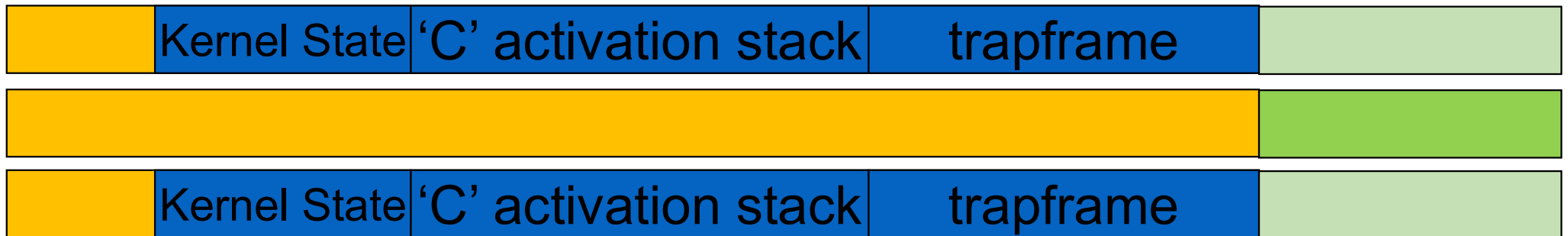

# Simplified OS/161 thread\_switch

```
static
void
thread_switch(threadstate_t newstate, struct wchan *wc)
{
    struct thread *cur, *next;

    cur = curthread;
    do {
        next = threadlist_remhead(&curcpu->c_runqueue);
        if (next == NULL) {
            cpu_idle();
        }
    } while (next == NULL);

    /* do the switch (in assembler in switch.S) */
    switchframe_switch(&cur->t_context, &next->t_context);
}
```

Lots of code removed – only basics of pick next thread and switch to it remain

# OS/161 switchframe\_switch

## switchframe\_switch:

```
/*
 * a0 contains the address of the switchframe pointer in the old thread.
 * a1 contains the address of the switchframe pointer in the new thread.
 *
 * The switchframe pointer is really the stack pointer. The other
 * registers get saved on the stack, namely:
 *
 *   s0-s6, s8
 *   gp, ra
 *
 * The order must match <mips/switchframe.h>.
 *
 * Note that while we'd ordinarily need to save s7 too, because we
 * use it to hold curthread saving it would interfere with the way
 * curthread is managed by thread.c. So we'll just let thread.c
 * manage it.
 */
```

# OS/161 switchframe\_switch

```
/* Allocate stack space for saving 10 registers. 10*4 = 40 */
```

```
addi sp, sp, -40
```

```
/* Save the registers */
```

```
sw ra, 36(sp)
```

```
sw gp, 32(sp)
```

```
sw s8, 28(sp)
```

```
sw s6, 24(sp)
```

```
sw s5, 20(sp)
```

```
sw s4, 16(sp)
```

```
sw s3, 12(sp)
```

```
sw s2, 8(sp)
```

```
sw s1, 4(sp)
```

```
sw s0, 0(sp)
```

```
/* Store the old stack pointer in the old thread */
```

```
sw sp, 0(a0)
```

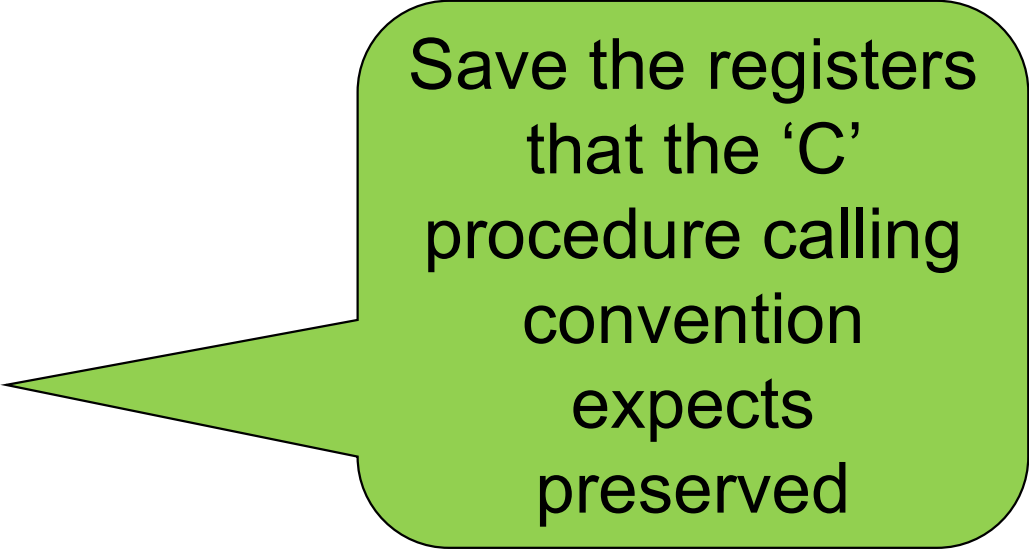

Save the registers  
that the 'C'  
procedure calling  
convention  
expects  
preserved

# OS/161 switchframe\_switch

```
/* Get the new stack pointer from the new thread */
```

```
lw sp, 0(a1)
```

```
nop      /* delay slot for load */
```

```
/* Now, restore the registers */
```

```
lw s0, 0(sp)
```

```
lw s1, 4(sp)
```

```
lw s2, 8(sp)
```

```
lw s3, 12(sp)
```

```
lw s4, 16(sp)
```

```
lw s5, 20(sp)
```

```
lw s6, 24(sp)
```

```
lw s8, 28(sp)
```

```
lw gp, 32(sp)
```

```
lw ra, 36(sp)
```

```
nop      /* delay slot for load */
```

# OS/161 switchframe\_switch

```
/* and return. */
```

```
j ra
```

```
addi sp, sp, 40 /* in delay slot */
```



Thread a

Thread b

# Revisiting Thread Switch

