

# Welcome to OS @ UNSW

COMP3231/9201/3891/9283  
(Extended) Operating Systems  
Dr. Kevin Elphinstone

# Q & A

# Back to Operating Systems

Chapter 1 – 1.3

Chapter 1.5 – 1.9

# Learning Outcomes

- High-level understand what is an operating system and the role it plays
- A high-level understanding of the structure of operating systems, applications, and the relationship between them.

# What is an Operating System?

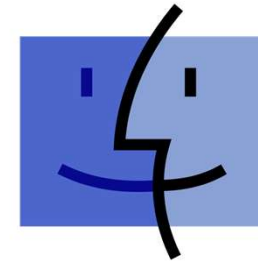
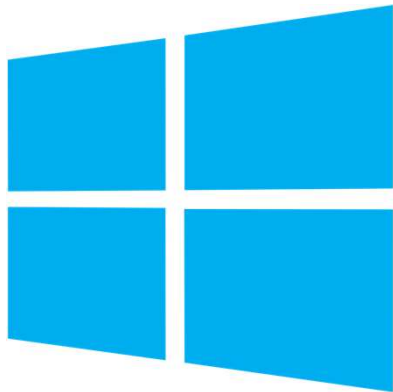

Mac OS

# What is a traffic light?

- A signalling device that controls the flow of traffic
  - Defined in terms of the **role** it plays
- A signalling device consisting of three lights mounted at an intersection
  - Defined in terms of what it **is**

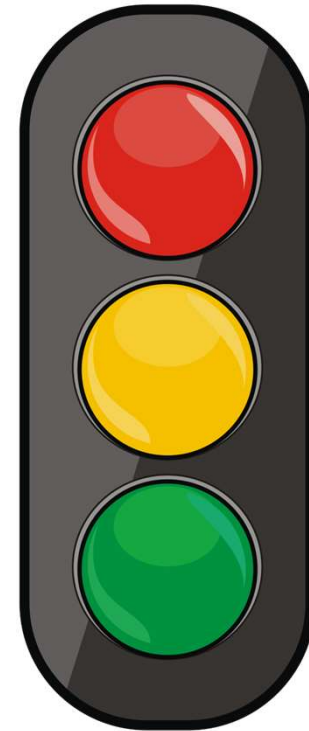

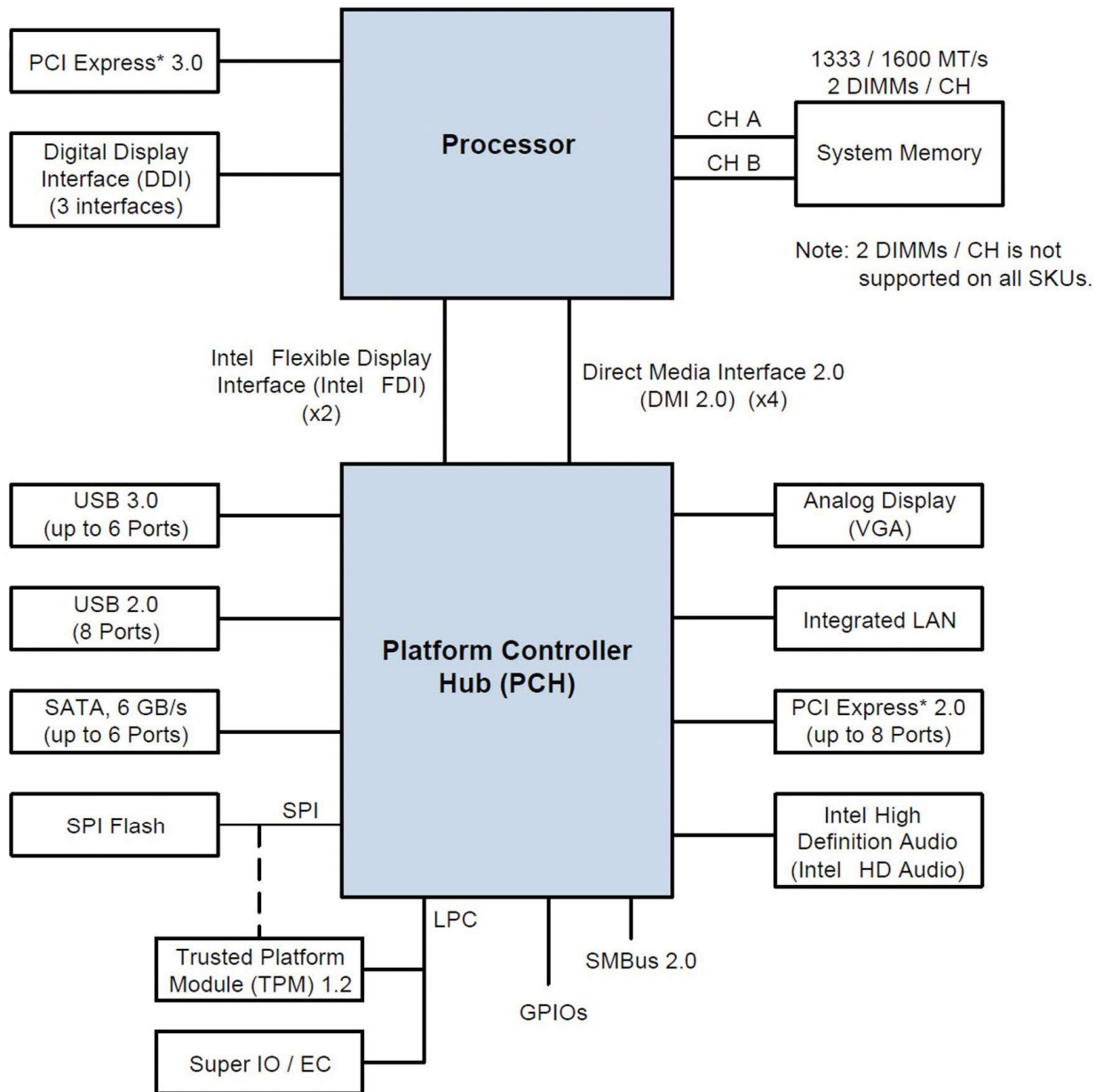

# *Role 1:* The Operating System is an Abstract Machine

- Extends the basic hardware with added functionality
- Provides high-level abstractions
  - More programmer friendly
  - Common core for all applications
    - E.g. Filesystem instead of just registers on a disk controller
- It hides the details of the hardware
  - Makes application code portable



Disk

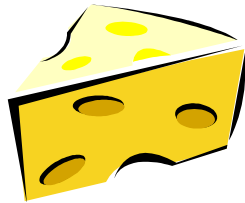

Memory

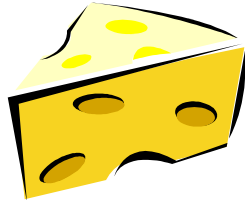

CPU

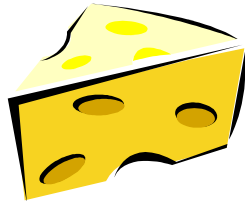

Network

Bandwidth

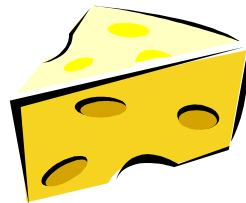

Users



## *Role 2: The Operating System is a Resource Manager*

- Responsible for allocating resources to users and processes
- Must ensure
  - No Starvation
  - Progress
  - Allocation is according to some desired policy
    - First-come, first-served; Fair share; Weighted fair share; limits (quotas), etc...
  - Overall, that the system is efficiently used

Structural (Implementation) View: the Operating System *is* the software *Privileged* mode.

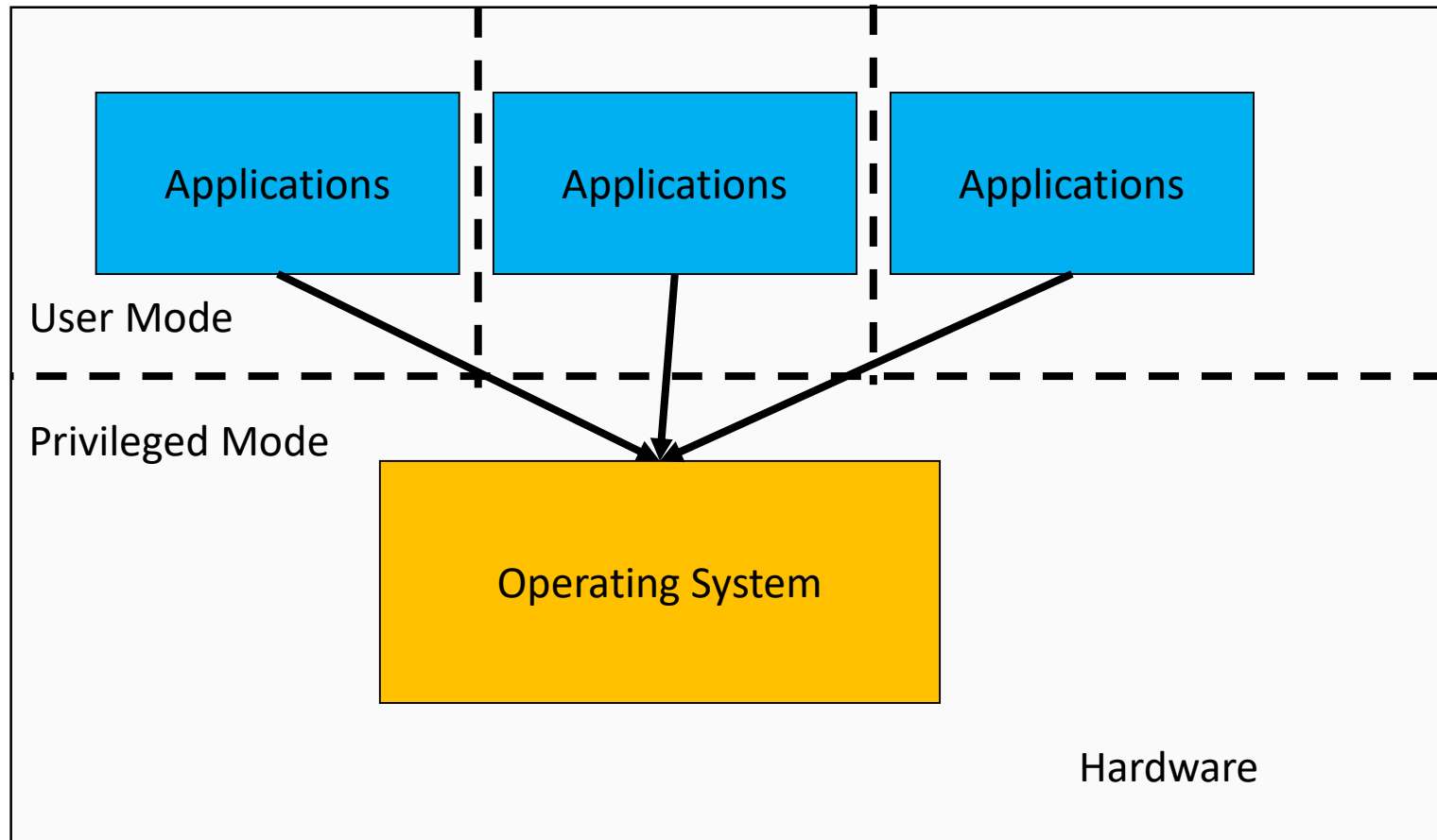

# Operating System Kernel

- Portion of the operating system that is running in *privileged mode*
- Usually resident (stays) in main memory
- Contains fundamental functionality
  - Whatever is required to implement other services
  - Whatever is required to provide security
- Contains most-frequently used functions
- Also called the nucleus or supervisor

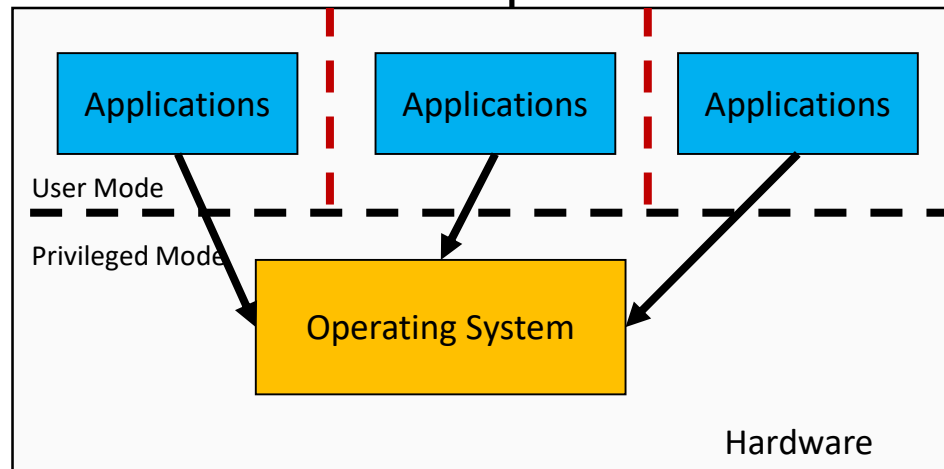

# The Operating System is Privileged

- Applications should not be able to interfere or bypass the operating system
  - OS can enforce the “extended machine”
  - OS can enforce its resource allocation policies
  - Prevent applications from interfering with each other

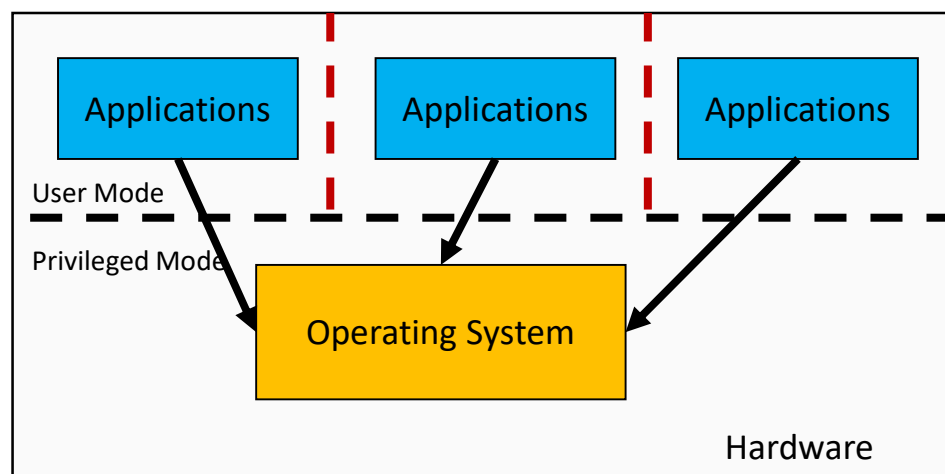

# Delving Deeper: The Structure of a Computer System

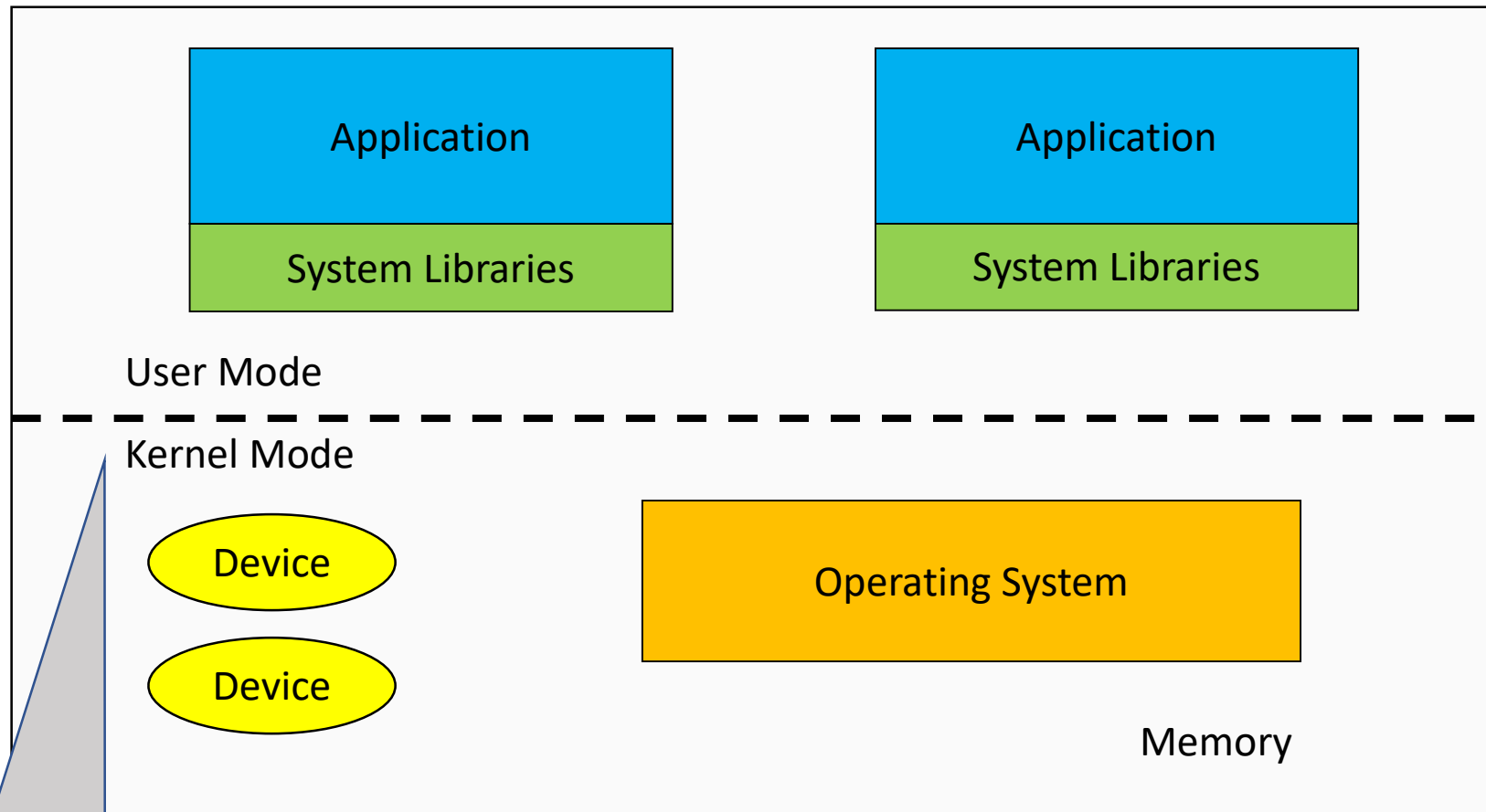

Kernel = Privileged  
Mode

# The Structure of a Computer System

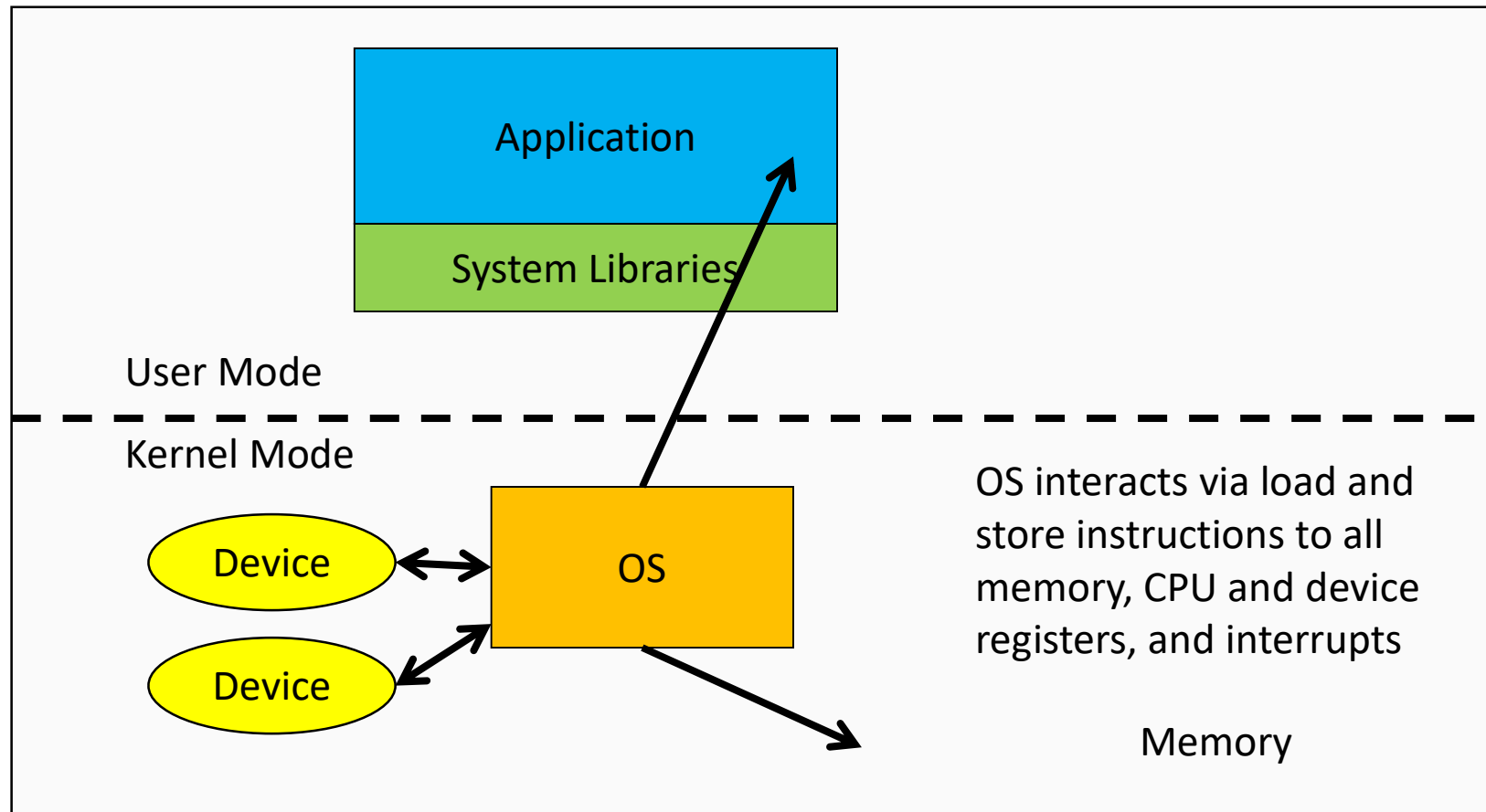

# The Structure of a Computer System

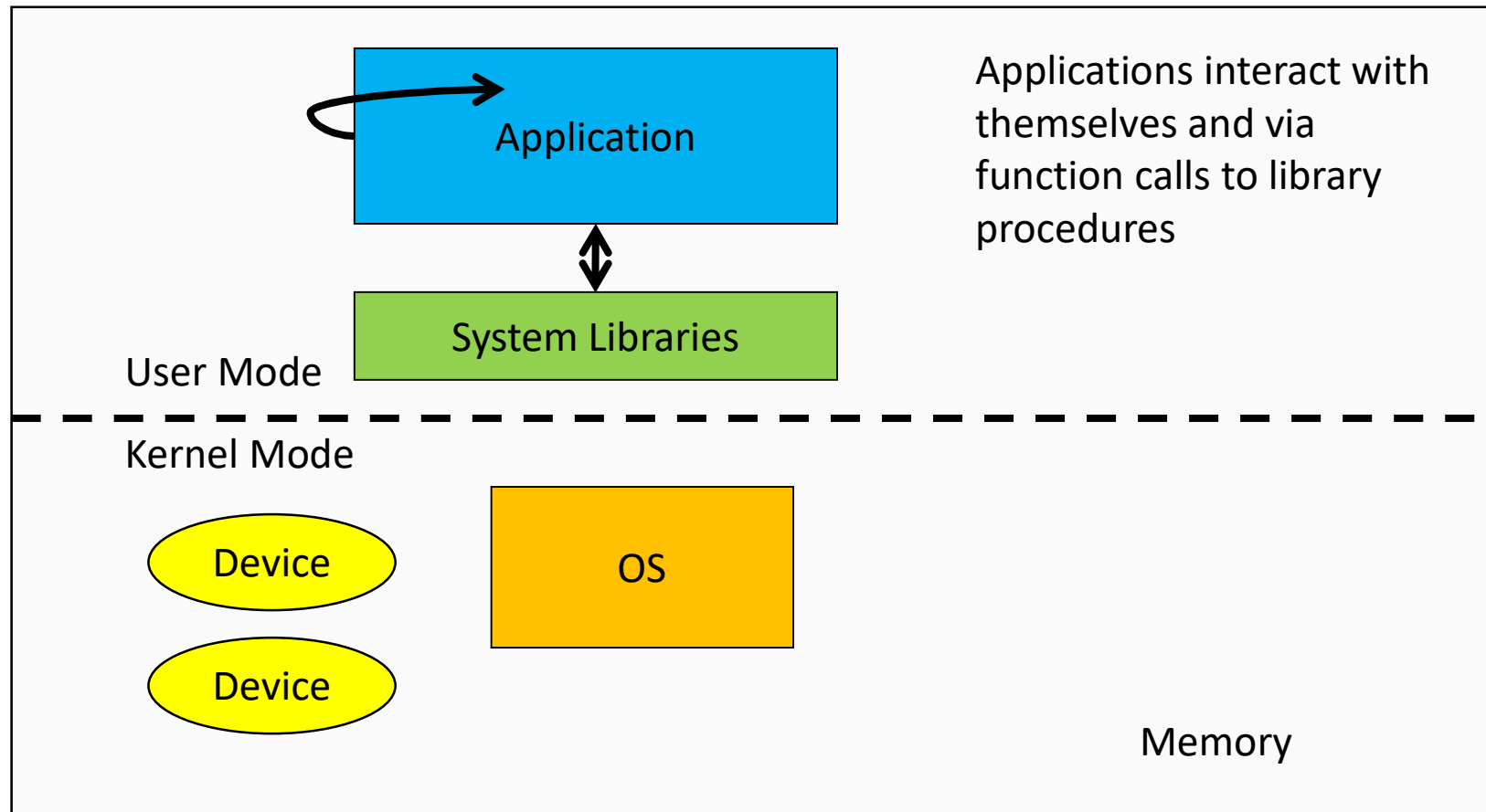



# The Structure of a Computer System

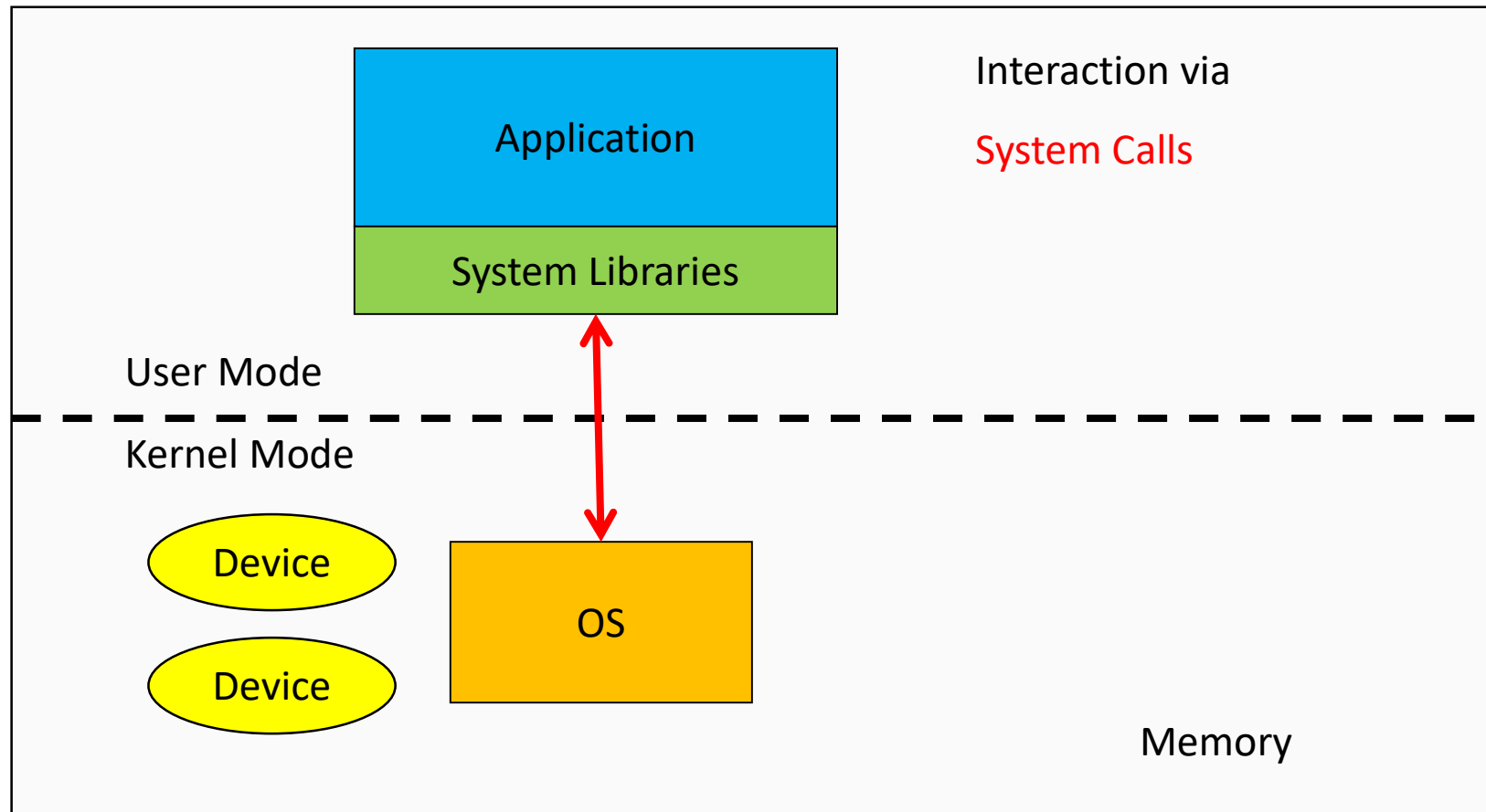

# Privilege-less OS

- Some Embedded OSs have no privileged component
  - e.g. PalmOS, Mac OS 9, RTEMS
- Can implement OS functionality, but cannot enforce it.
  - All software runs together
  - No isolation
  - One fault potentially brings down entire system

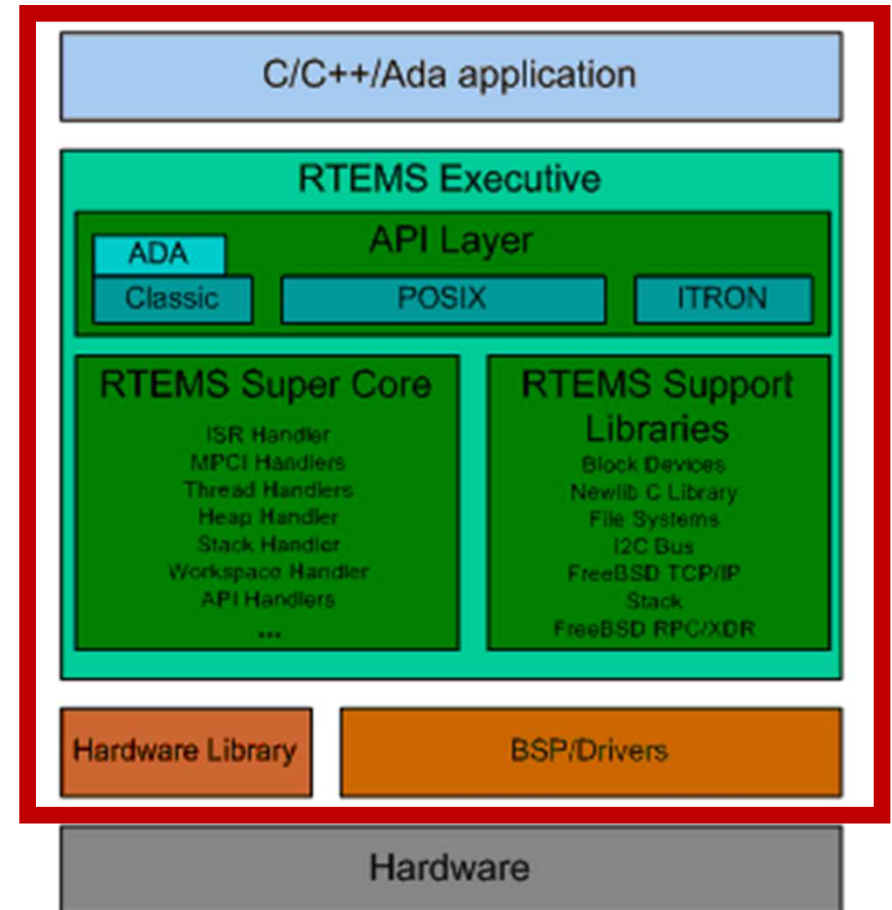

# A Note on System Libraries

System libraries are just that, libraries of support functions (procedures, subroutines)

- Only a subset of library functions are actually system calls
  - `strcmp()`, `memcpy()`, are pure library functions
    - manipulate memory within the application, or perform computation
  - `open()`, `close()`, `read()`, `write()` are system calls
    - they cross the user-kernel boundary, e.g. to read from disk device
    - Implementation mainly focused on passing request to OS and returning result to application
- System call functions are in the library for convenience
  - try `man syscalls` on Linux

# Operating System Software

- Fundamentally, OS functions the same way as ordinary computer software
  - It is machine code that is executed (same machine instructions as application)
  - It has more privileges (extra instructions and access)
- Operating system relinquishes control of the processor to execute other programs
  - Reestablishes control after
    - System calls
    - Interrupts (especially timer interrupts)

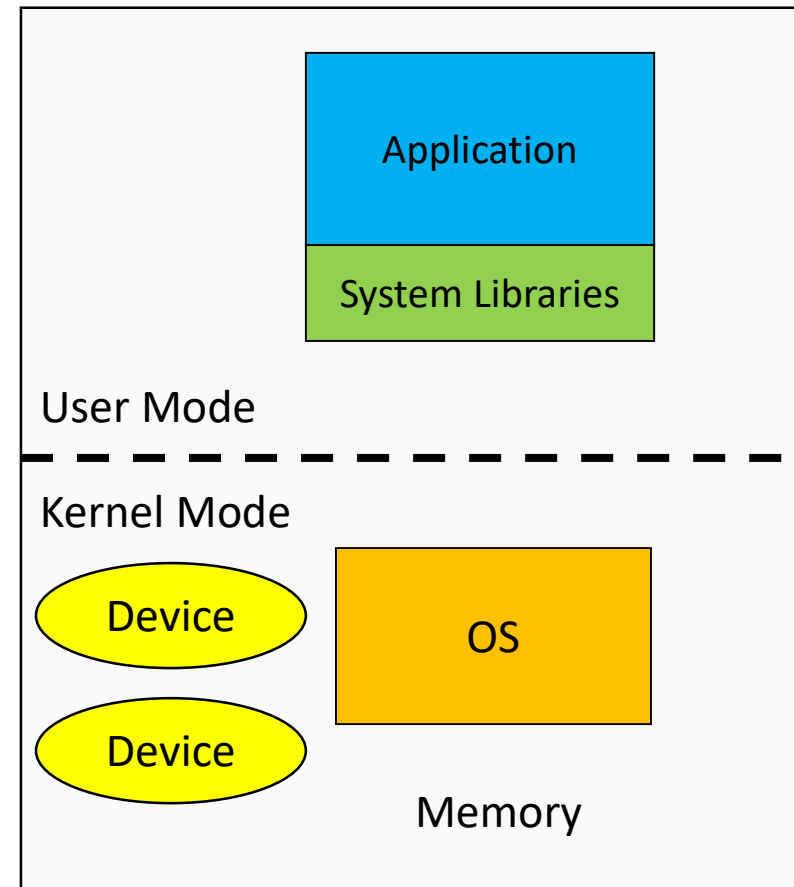

# Operating System Internal Structure?

# The Monolithic Operating System Structure

- Also called the “spaghetti nest” approach
  - Everything is tangled up with everything else.
- Linux, Windows, ....

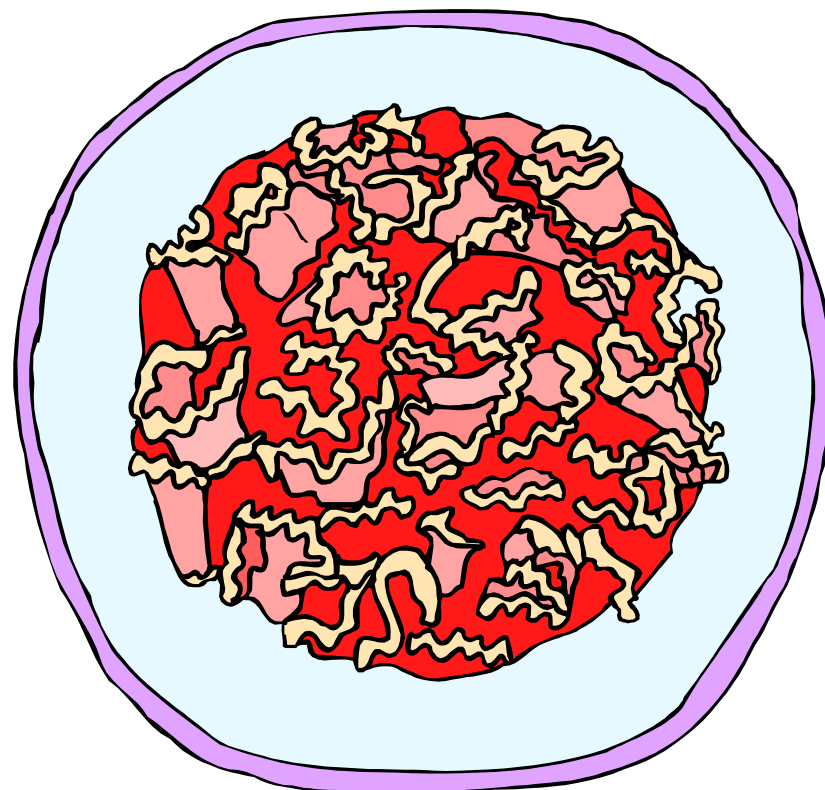

# The Monolithic Operating System Structure

- However, some reasonable structure usually prevails

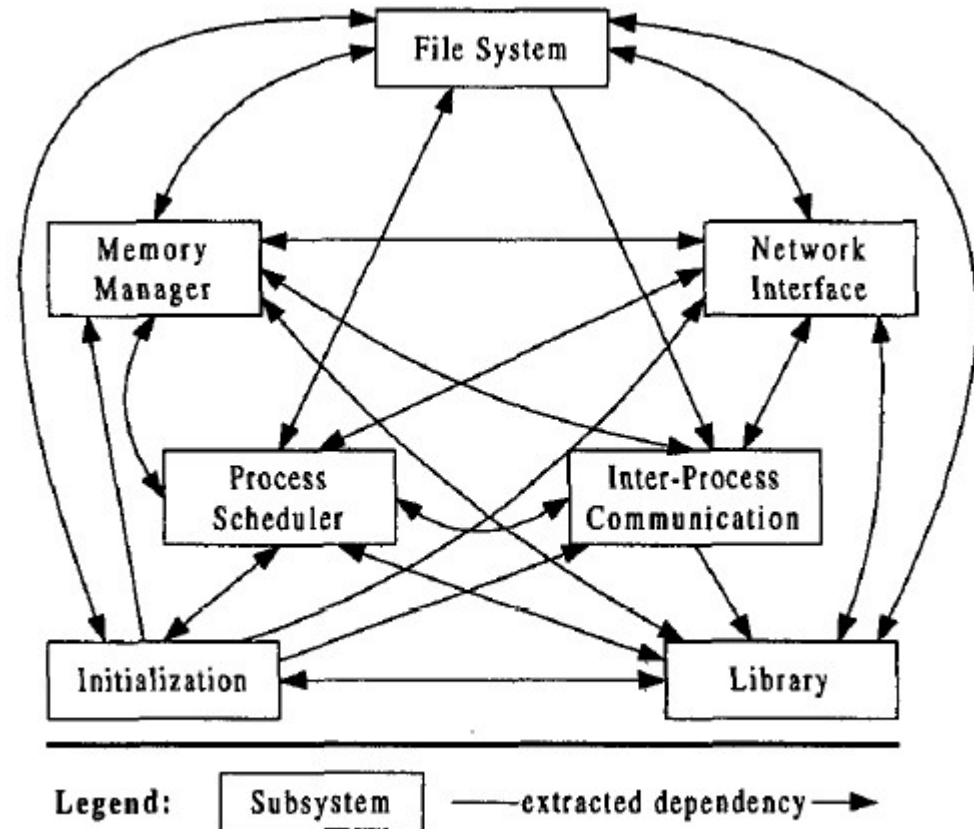

Bowman, I. T., Holt, R. C., and Brewster, N. V. 1999. Linux as a case study: its extracted software architecture. In *Proceedings of the 21st international Conference on Software Engineering* (Los Angeles, California, United States, May 16 - 22, 1999). ICSE '99. ACM, New York, NY, 555-563. DOI= <http://doi.acm.org/10.1145/302405.302691>

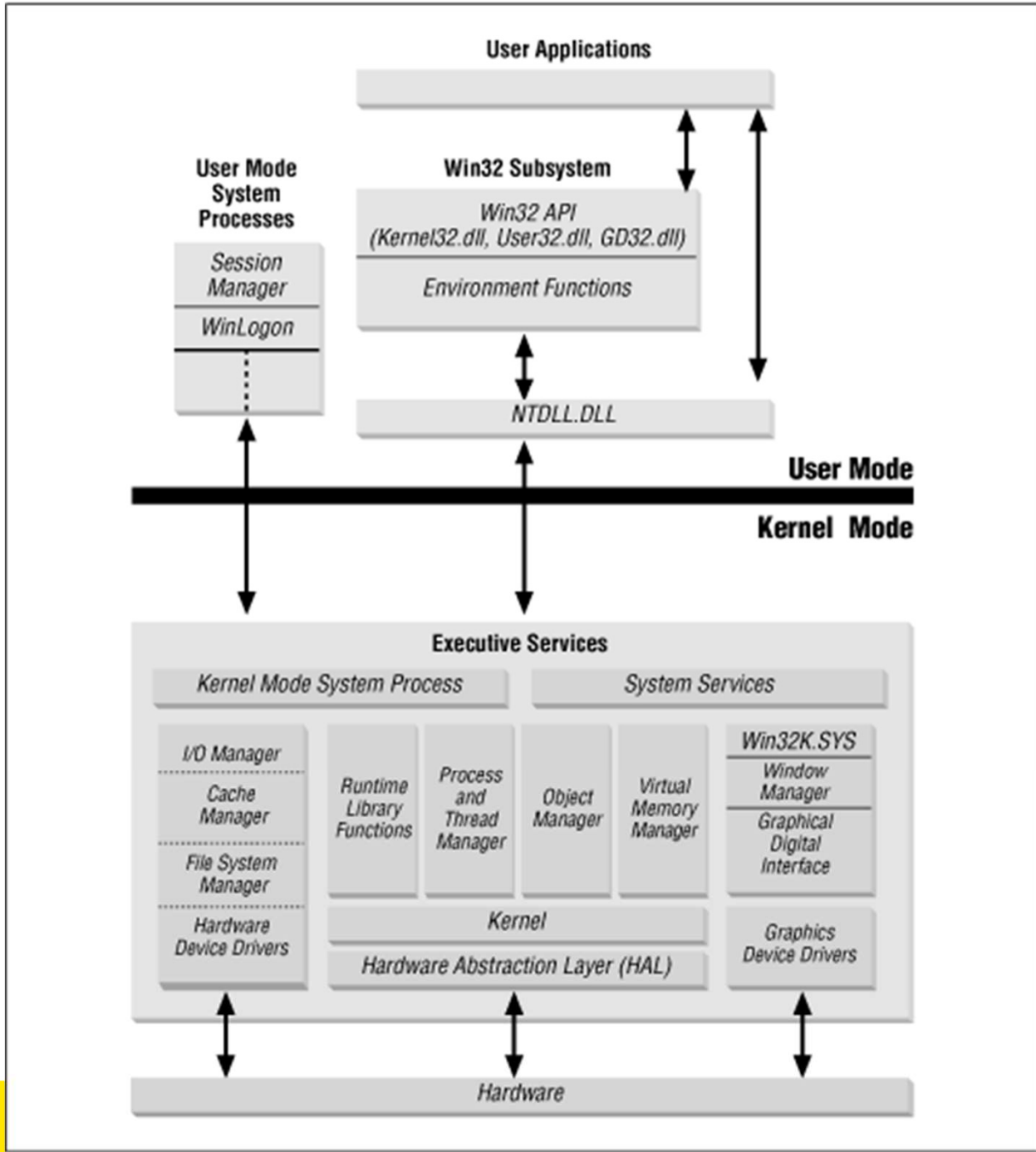



The end