

Scheduling



Learning Outcomes

- Understand the role of the scheduler, and how its behaviour influences the performance of the system.
- Know the difference between I/O-bound and CPU-bound tasks, and how they relate to scheduling.



What is Scheduling?

- On a multi-programmed system
 - We may have more than one *Ready* process
- On a batch system
 - We may have many jobs waiting to be run
- On a multi-user system
 - We may have many users concurrently using the system
- The ***scheduler*** decides who to run next.
 - The process of choosing is called *scheduling*.



Is scheduling important?

- It is not in certain scenarios
 - If you have no choice
 - Early systems
 - Usually batching
 - Scheduling algorithm simple
 - » Run next on tape or next on punch tape
 - Only one thing to run
 - Simple PCs
 - Only ran a word processor, etc....
 - Simple Embedded Systems
 - TV remote control, washing machine, etc....



Is scheduling important?

- It is in most realistic scenarios
 - Multitasking/Multi-user System
 - Example
 - Email daemon takes 2 seconds to process an email
 - User clicks button on application.
 - Scenario 1
 - Run daemon, then application
 - » System appears really sluggish to the user
 - Scenario 2
 - Run application, then daemon
 - » Application appears really responsive, small email delay is unnoticed
- Scheduling decisions can have a dramatic effect on the perceived performance of the system
 - Can also affect correctness of a system with deadlines



Application Behaviour

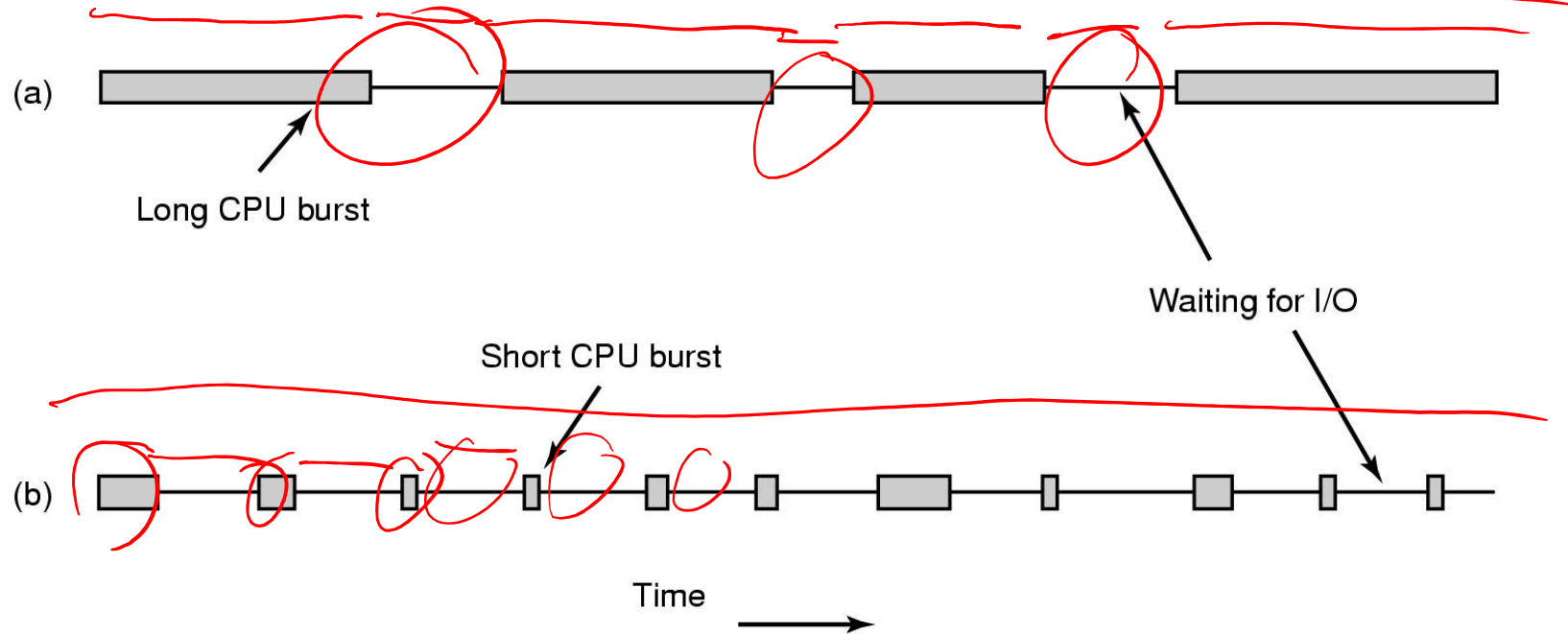

- Bursts of CPU usage alternate with periods of I/O wait



Application Behaviour

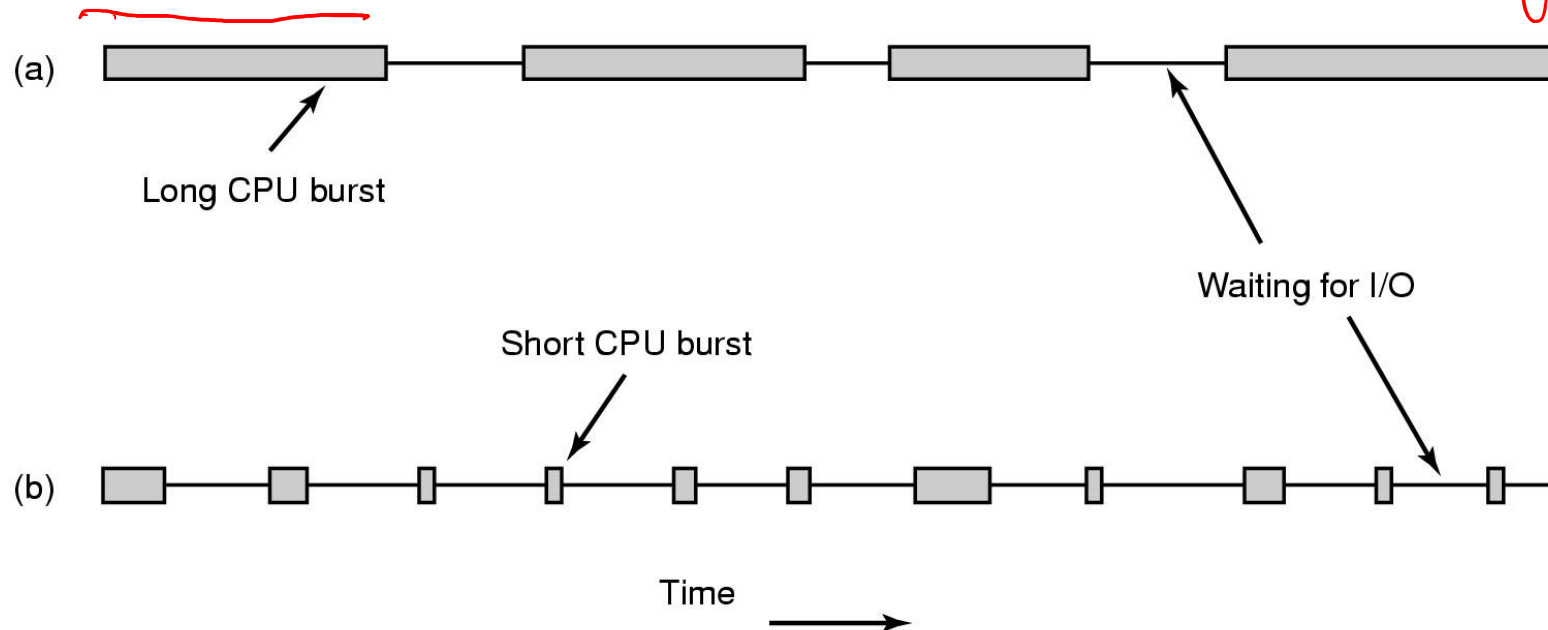

a) CPU-Bound process

- Spends most of its computing
- Time to completion largely determined by received CPU time



Application Behaviour

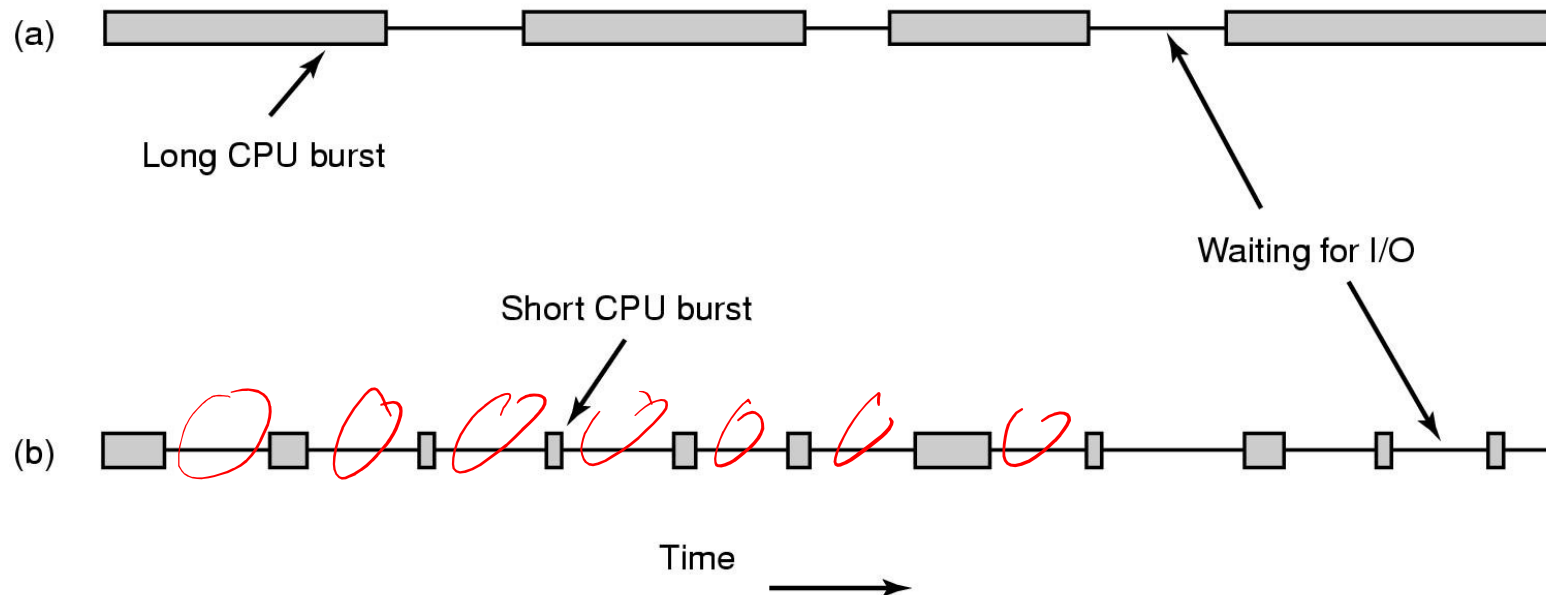

b) I/O-Bound process

- Spend most of its time waiting for I/O to complete
 - Small bursts of CPU to process I/O and request next I/O
- Time to completion largely determined by I/O request time



Observation

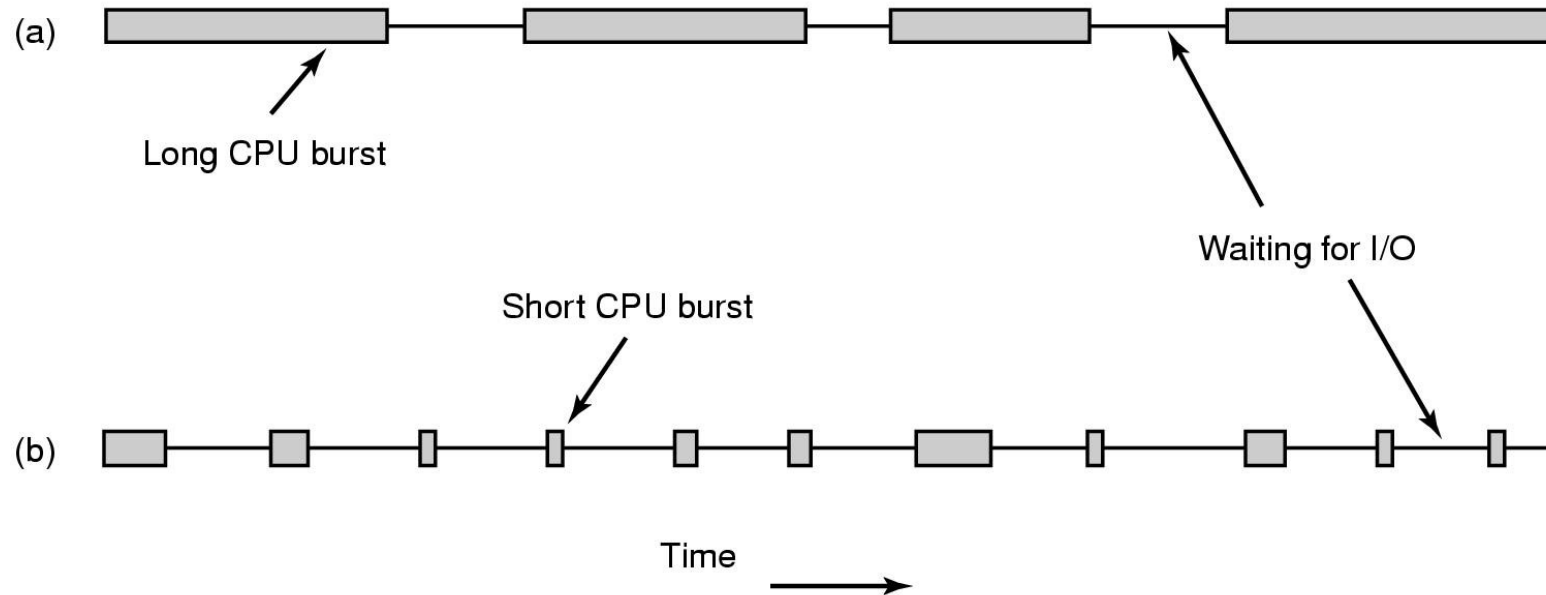

- We need a mix of CPU-bound and I/O-bound processes to keep both CPU and I/O systems busy
- Process can go from CPU- to I/O-bound (or vice versa) in different phases of execution



Key Insight

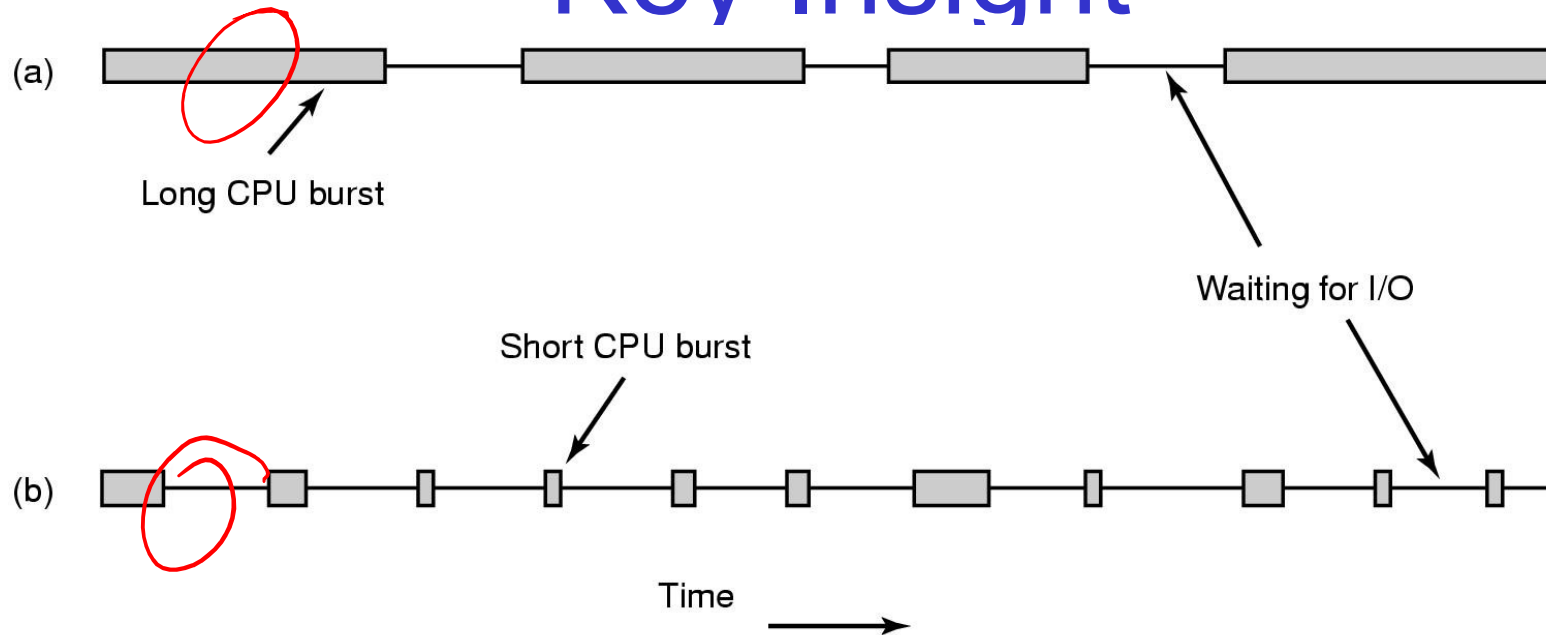

- Choosing to run an I/O-bound process delays a CPU-bound process by very little
 - Choosing to run a CPU-bound process prior to an I/O-bound process delays the next I/O request significantly
 - No overlap of I/O waiting with computation
 - Results in device (disk) not as busy as possible
- ⇒ Generally, favour I/O-bound processes over CPU-bound processes



When is scheduling performed?

- A new process
 - Run the parent or the child?
- A process exits
 - Who runs next?
- A process waits for I/O
 - Who runs next?
- A process blocks on a lock
 - Who runs next? The lock holder?
- An I/O interrupt occurs
 - Who do we resume, the interrupted process or the process that was waiting?
- On a timer interrupt? (See next slide)
- Generally, a scheduling decision is required when a process (or thread) can no longer continue, or when an activity results in more than one ready process.



Preemptive versus Non-preemptive Scheduling

- Non-preemptive
 - Once a thread is in the *running* state, it continues until it completes, blocks on I/O, or voluntarily yields the CPU
 - A single process can monopolised the entire system
- Preemptive Scheduling
 - Current thread can be interrupted by OS and moved to *ready* state.
 - Usually after a timer interrupt and process has exceeded its maximum run time
 - Can also be as a result of higher priority process that has become *ready* (after I/O interrupt).
 - Ensures fairer service as single thread can't monopolise the system
 - Requires a timer interrupt



Categories of Scheduling Algorithms

- The choice of scheduling algorithm depends on the goals of the application (or the operating system)
 - No one algorithm suits all environments
- We can roughly categorise scheduling algorithms as follows
 - Batch Systems
 - No users directly waiting, can optimise for overall machine performance
 - Interactive Systems
 - Users directly waiting for their results, can optimise for users perceived performance
 - Realtime Systems
 - Jobs have deadlines, must schedule such that all jobs (predictably) meet their deadlines.



Goals of Scheduling Algorithms

- All Algorithms
 - Fairness
 - Give each process a *fair* share of the CPU
 - Policy Enforcement
 - What ever policy chosen, the scheduler should ensure it is carried out
 - Balance/Efficiency
 - Try to keep all parts of the system busy



Goals of Scheduling Algorithms

- Interactive Algorithms
 - Minimise *response time*
 - Response time is the time difference between issuing a command and getting the result
 - E.g selecting a menu, and getting the result of that selection
 - Response time is important to the user's perception of the performance of the system.
 - Provide *Proportionality*
 - Proportionality is the user expectation that short jobs will have a short response time, and long jobs can have a long response time.
 - Generally, favour short jobs



Goals of Scheduling Algorithms

- Real-time Algorithms
 - Must meet deadlines
 - Each job/task has a deadline.
 - A missed deadline can result in data loss or catastrophic failure
 - Aircraft control system missed deadline to apply brakes
 - Provide Predictability
 - For some apps, an occasional missed deadline is okay
 - E.g. DVD decoder
 - Predictable behaviour allows smooth DVD decoding with only rare skips



Interactive Scheduling



Round Robin Scheduling

- Each process is given a *timeslice* to run in
- When the timeslice expires, the next process preempts the current process, and runs for its timeslice, and so on
 - The preempted process is placed at the end of the queue
- Implemented with
 - A ready queue
 - A regular timer interrupt



Example

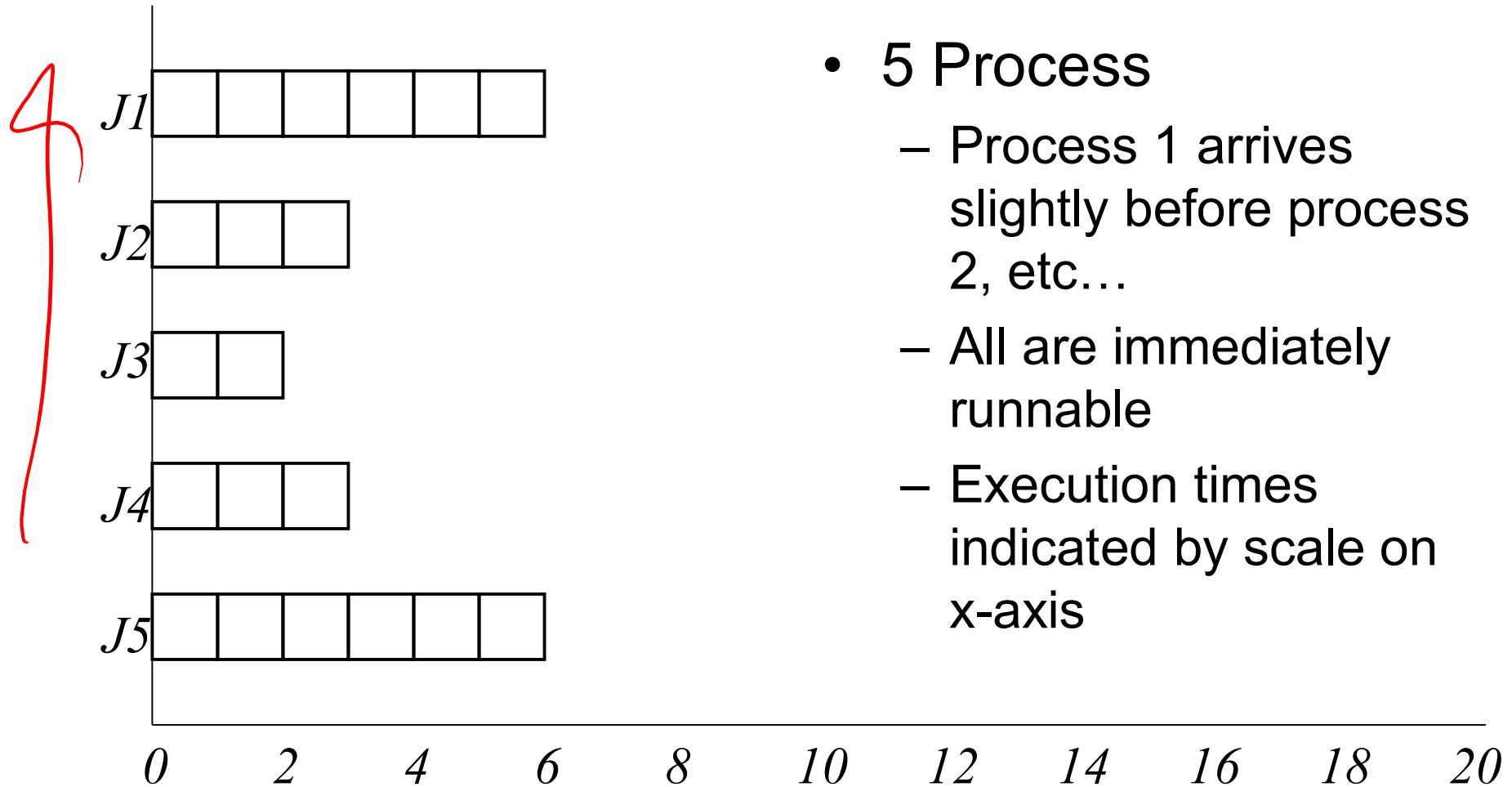

- 5 Process

- Process 1 arrives slightly before process 2, etc...
- All are immediately runnable
- Execution times indicated by scale on x-axis



Round Robin Schedule

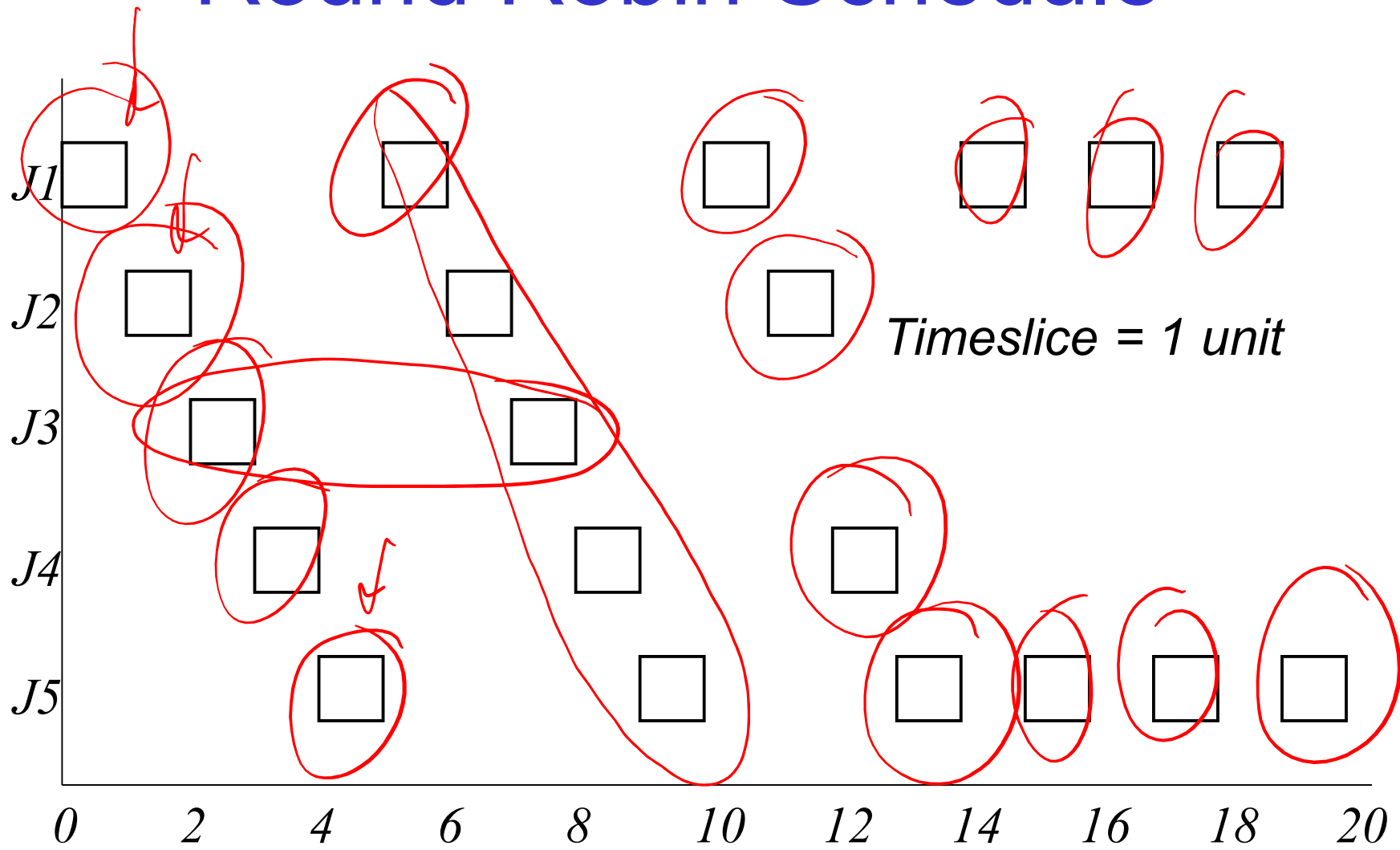

Round Robin Schedule

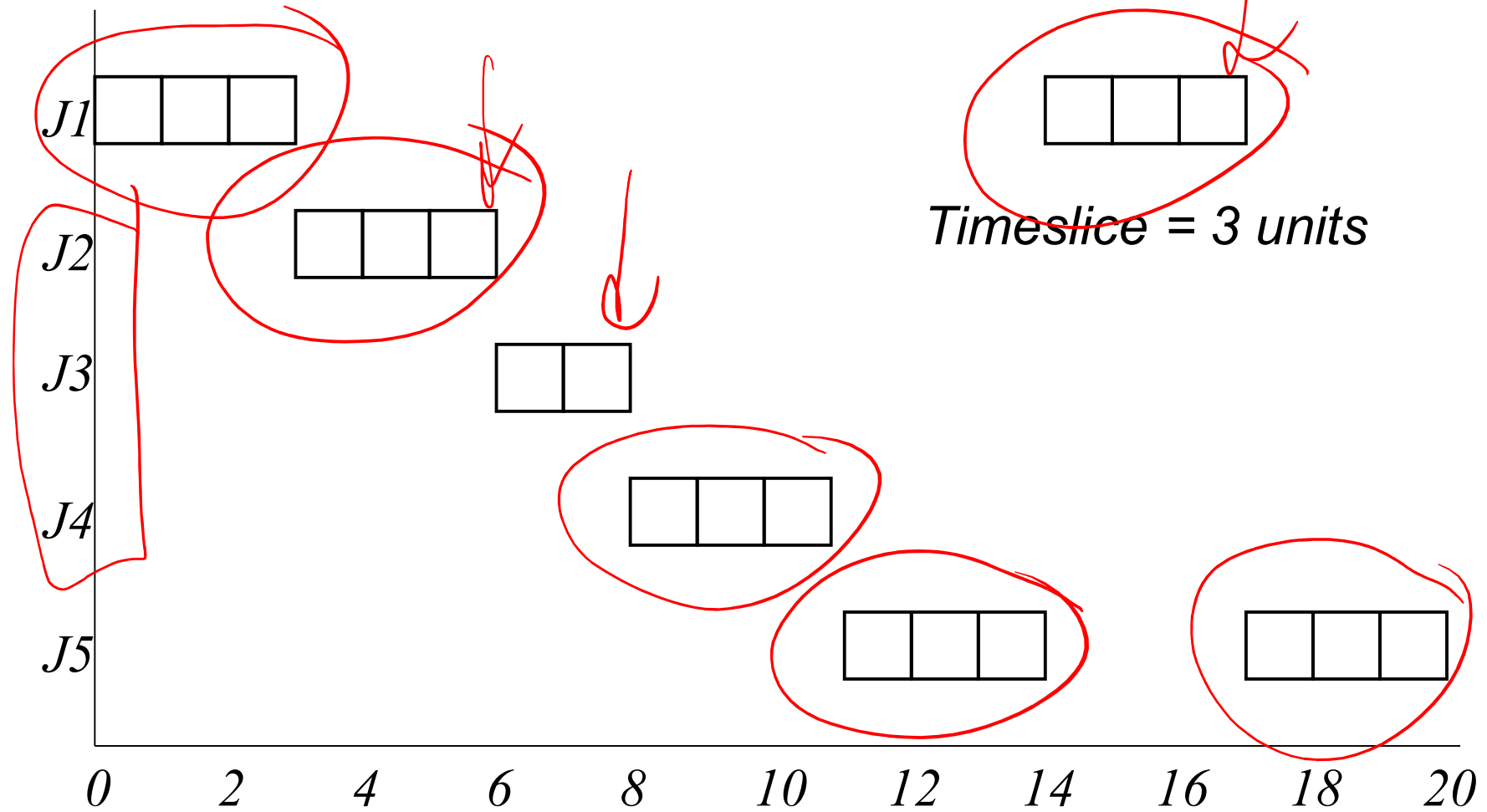

Round Robin

- Pros
 - Fair, easy to implement
- Con
 - Assumes everybody is equal
- Issue: What should the timeslice be?
 - Too short
 - Waste a lot of time switching between processes
 - Example: timeslice of 4ms with 1 ms context switch = 20% round robin overhead
 - Too long
 - System is not responsive
 - Example: timeslice of 100ms
 - If 10 people hit “enter” key simultaneously, the last guy to run will only see progress after 1 second.
 - Degenerates into FCFS if timeslice longer than burst length



Priorities

- Each Process (or thread) is associated with a priority
- Provides basic mechanism to influence a scheduler decision:
 - Scheduler will always chooses a thread of higher priority over lower priority
- Priorities can be defined internally or externally
 - Internal: e.g. I/O bound or CPU bound
 - External: e.g. based on importance to the user



Example

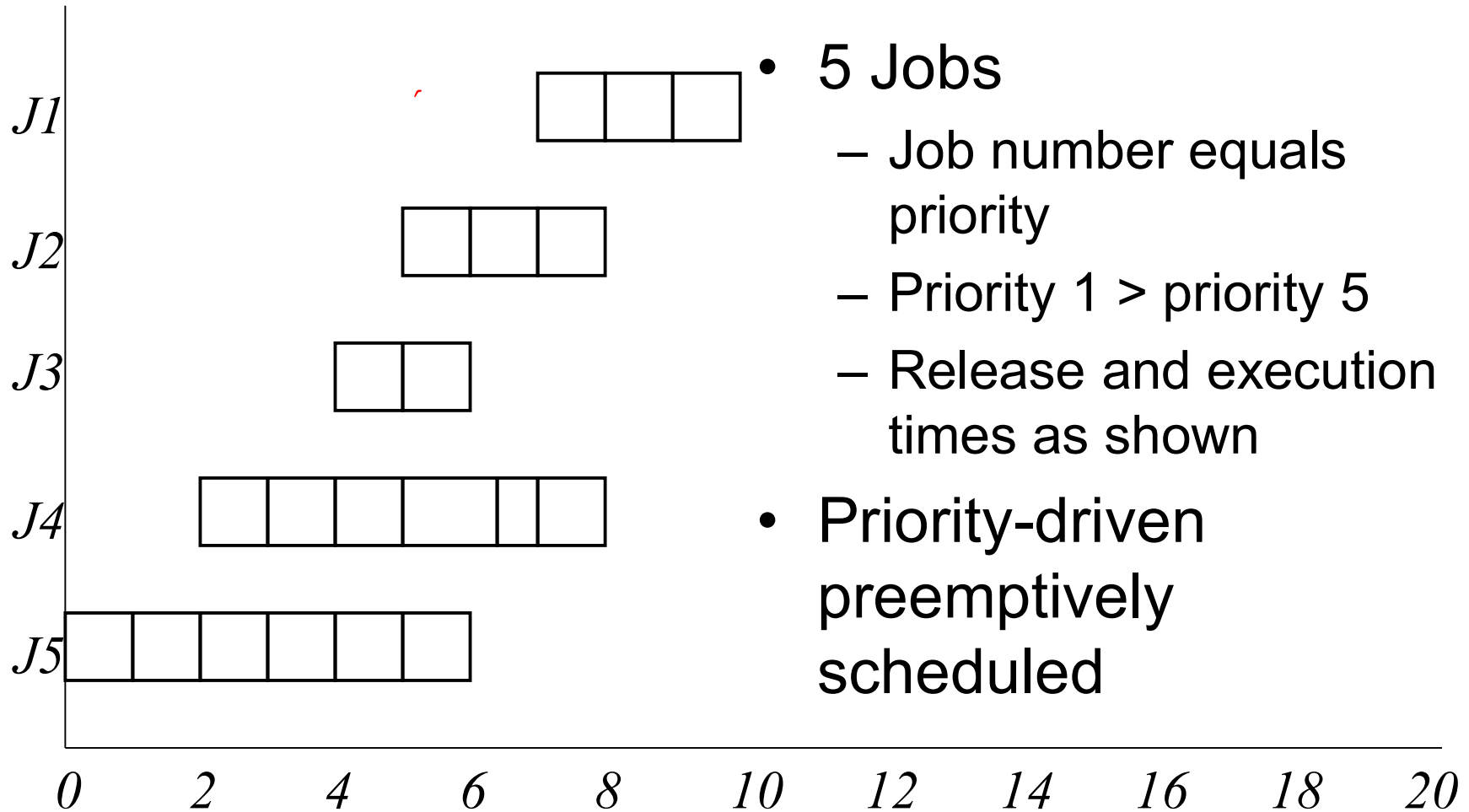

- 5 Jobs
 - Job number equals priority
 - Priority 1 > priority 5
 - Release and execution times as shown
- Priority-driven preemptively scheduled



Example

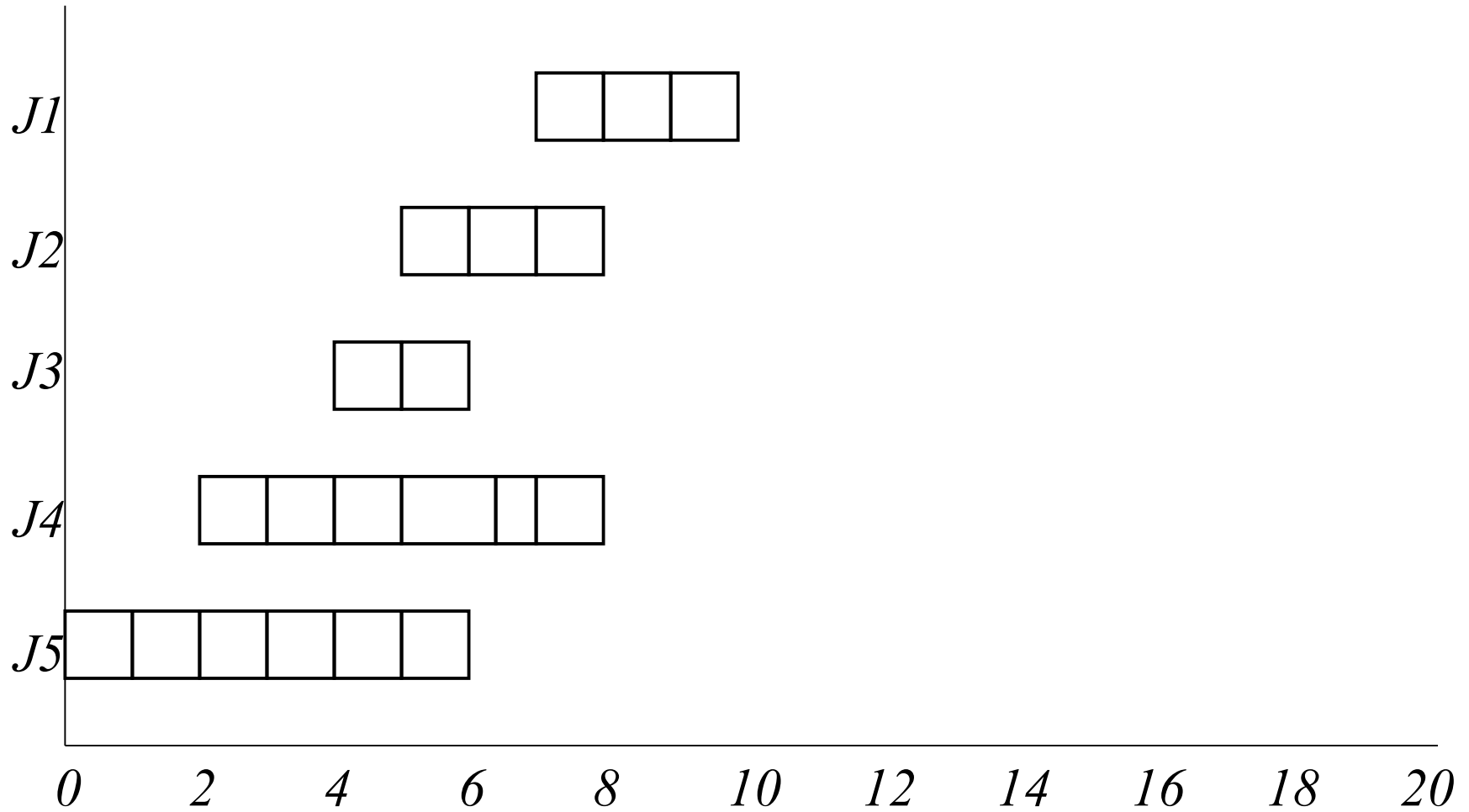

Example

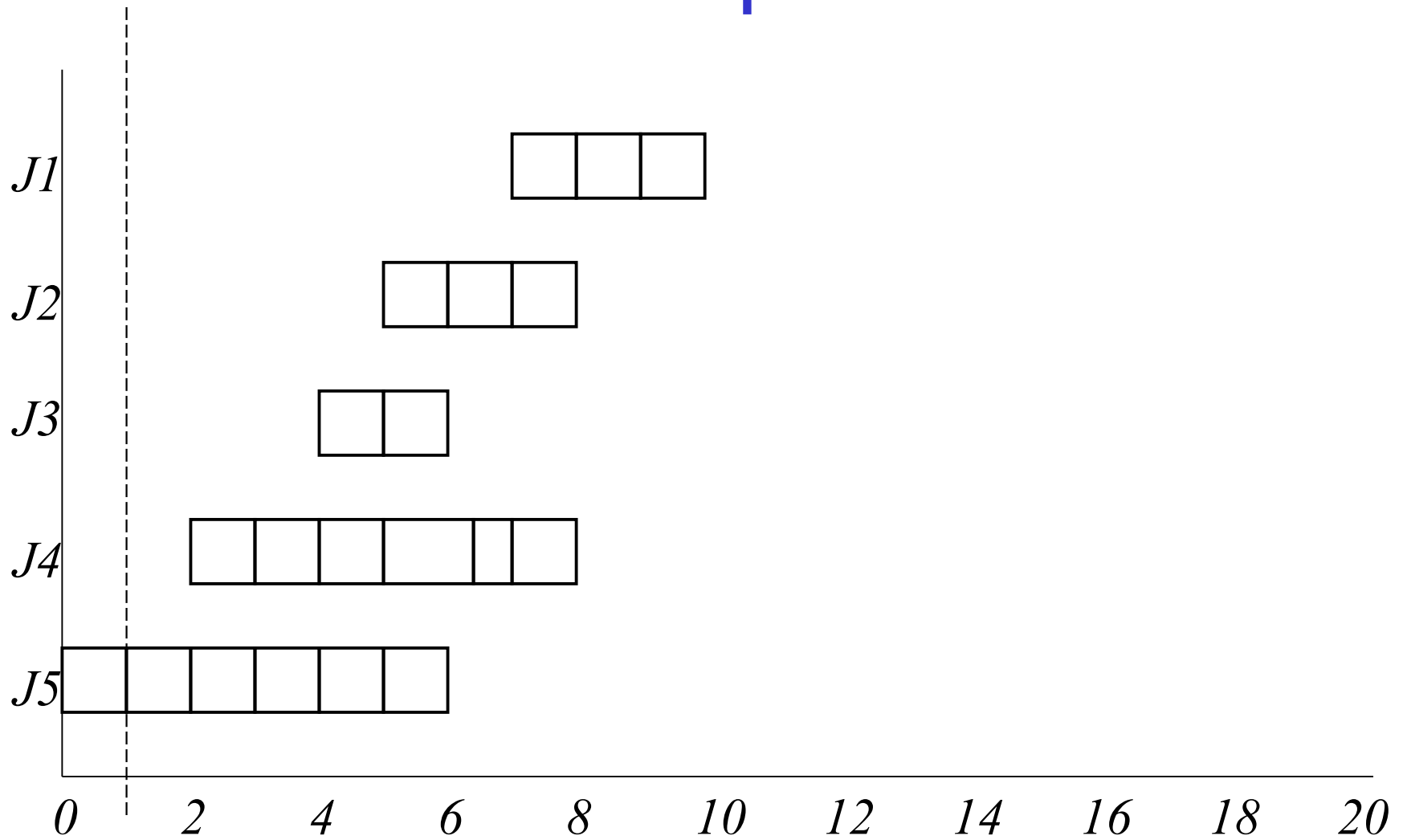

Example

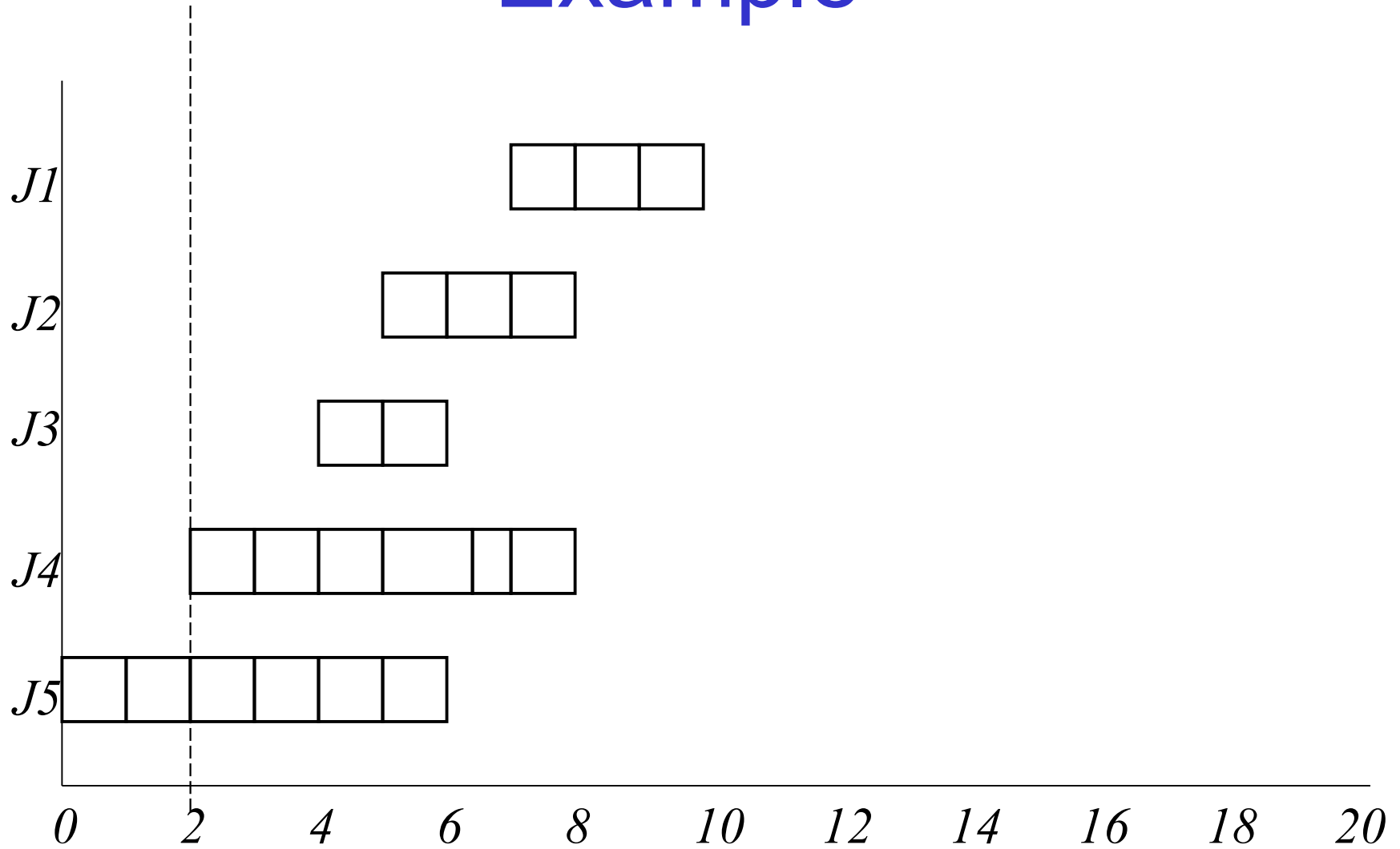

Example

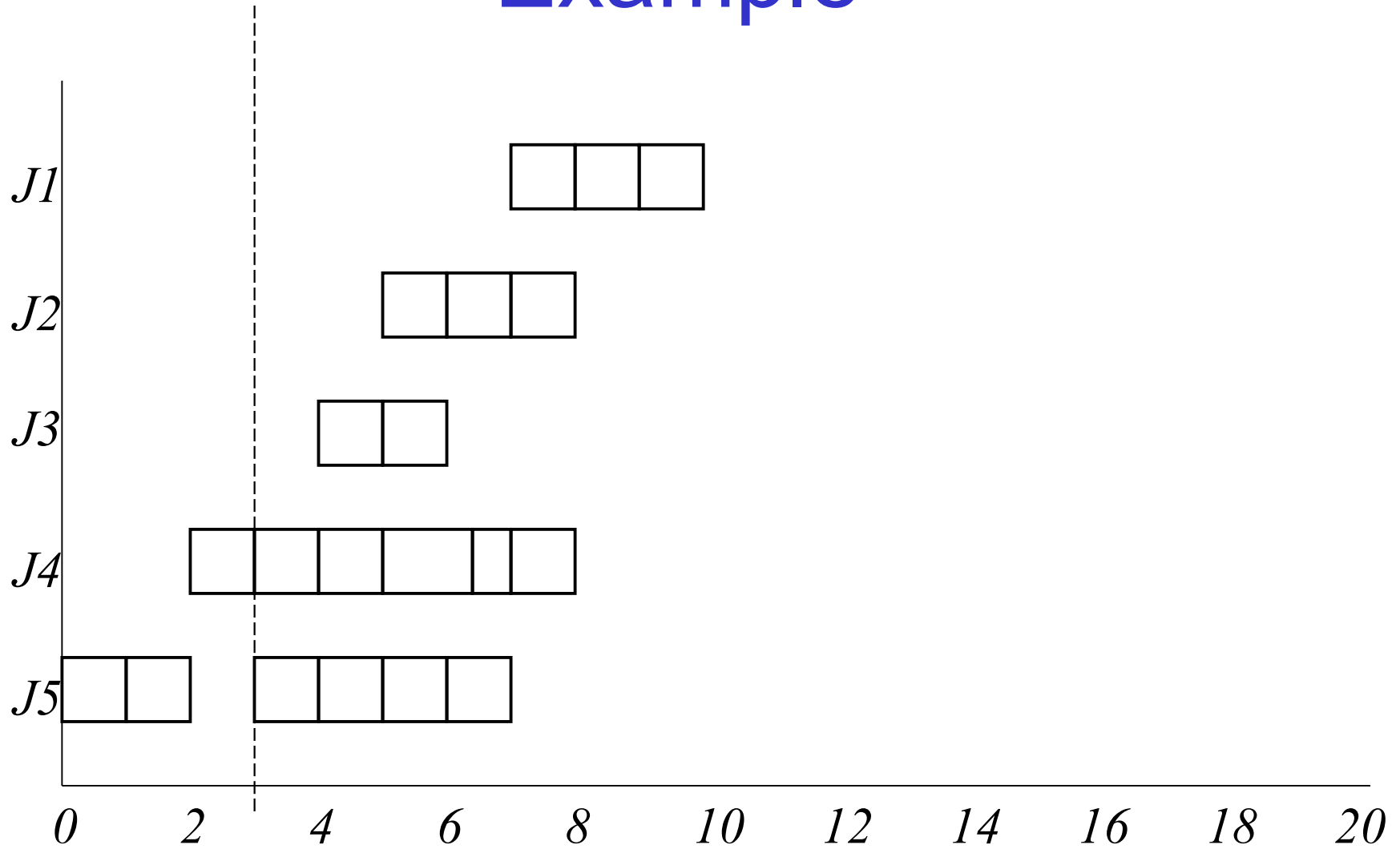

Example

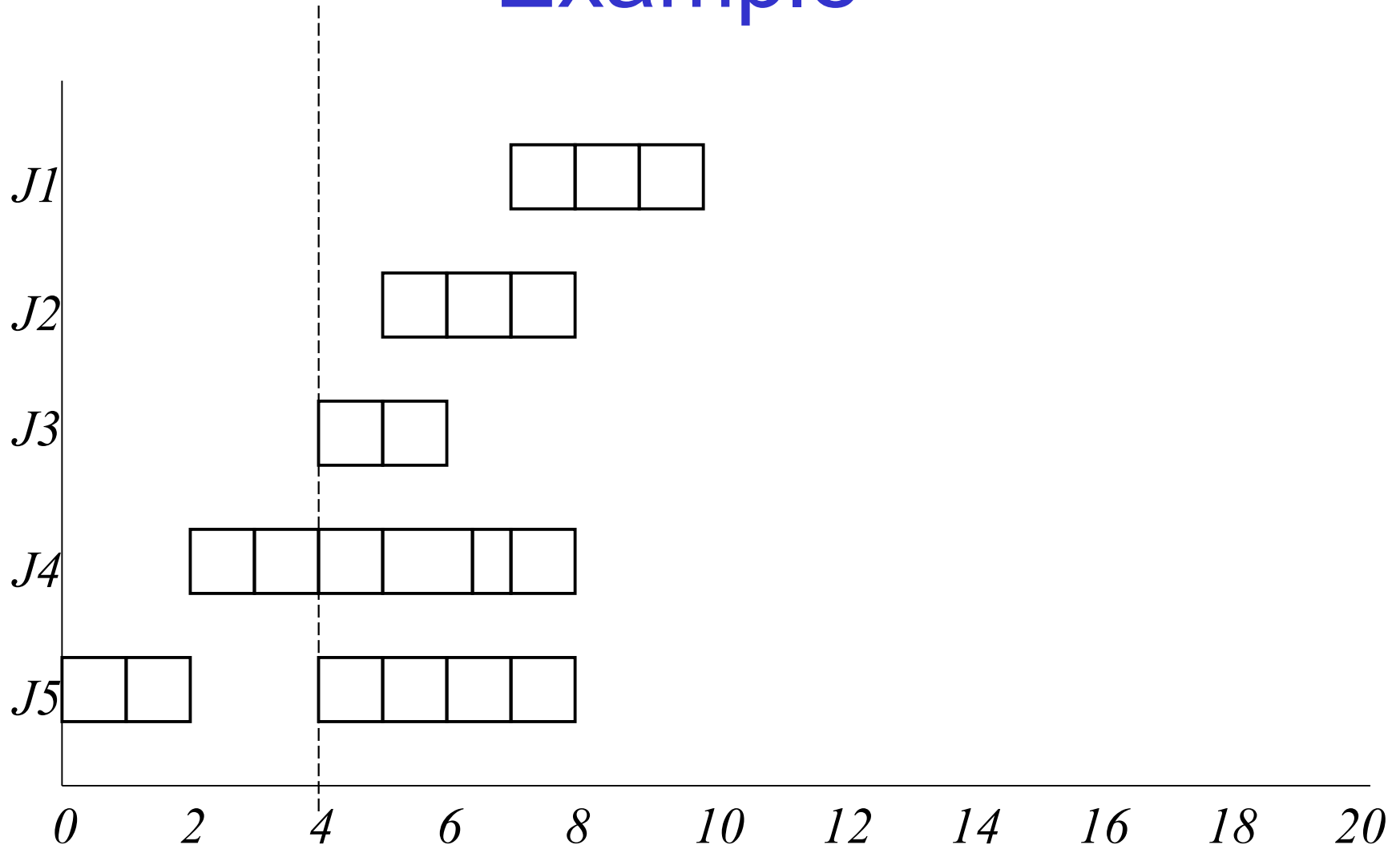

Example

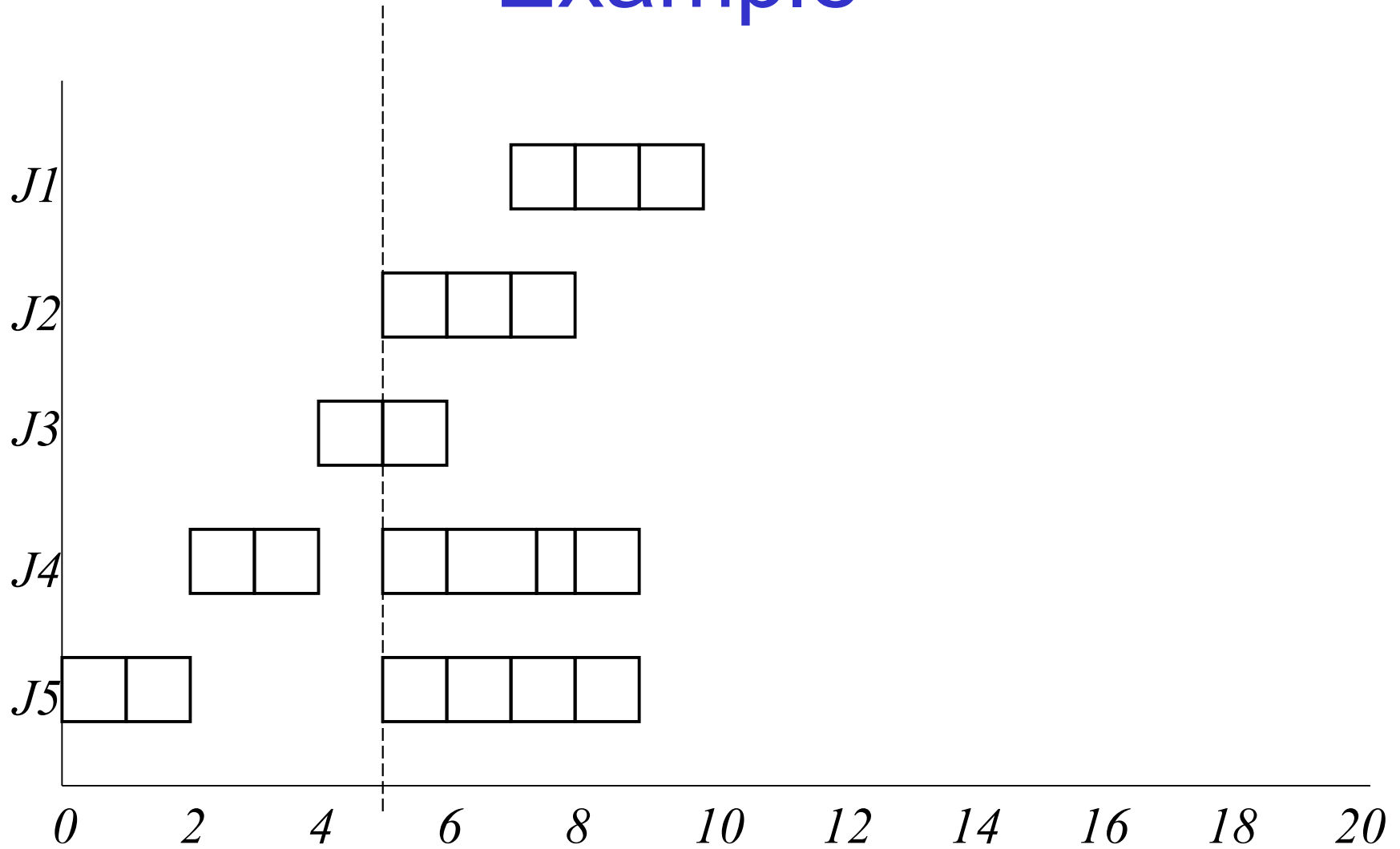

Example

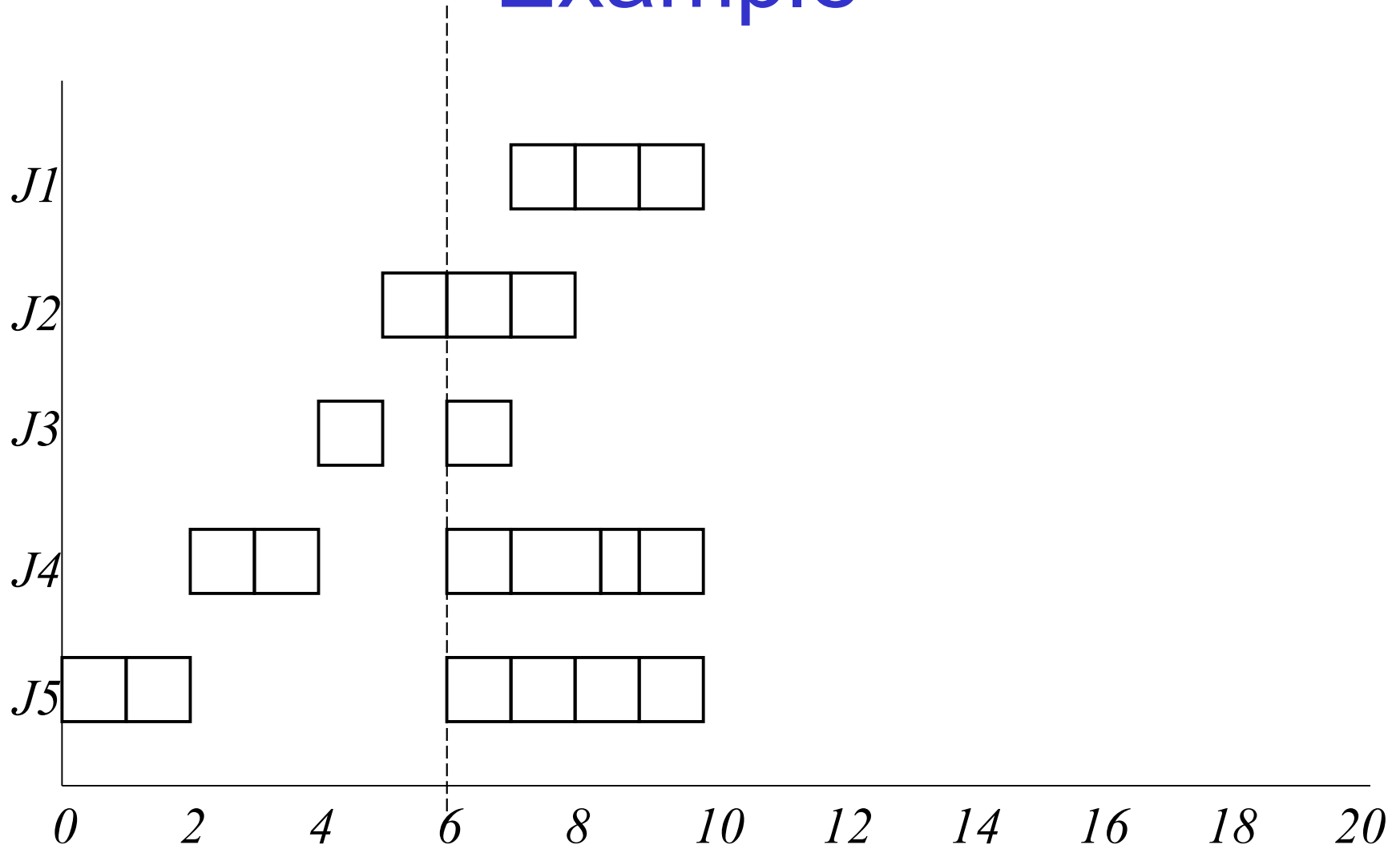

Example

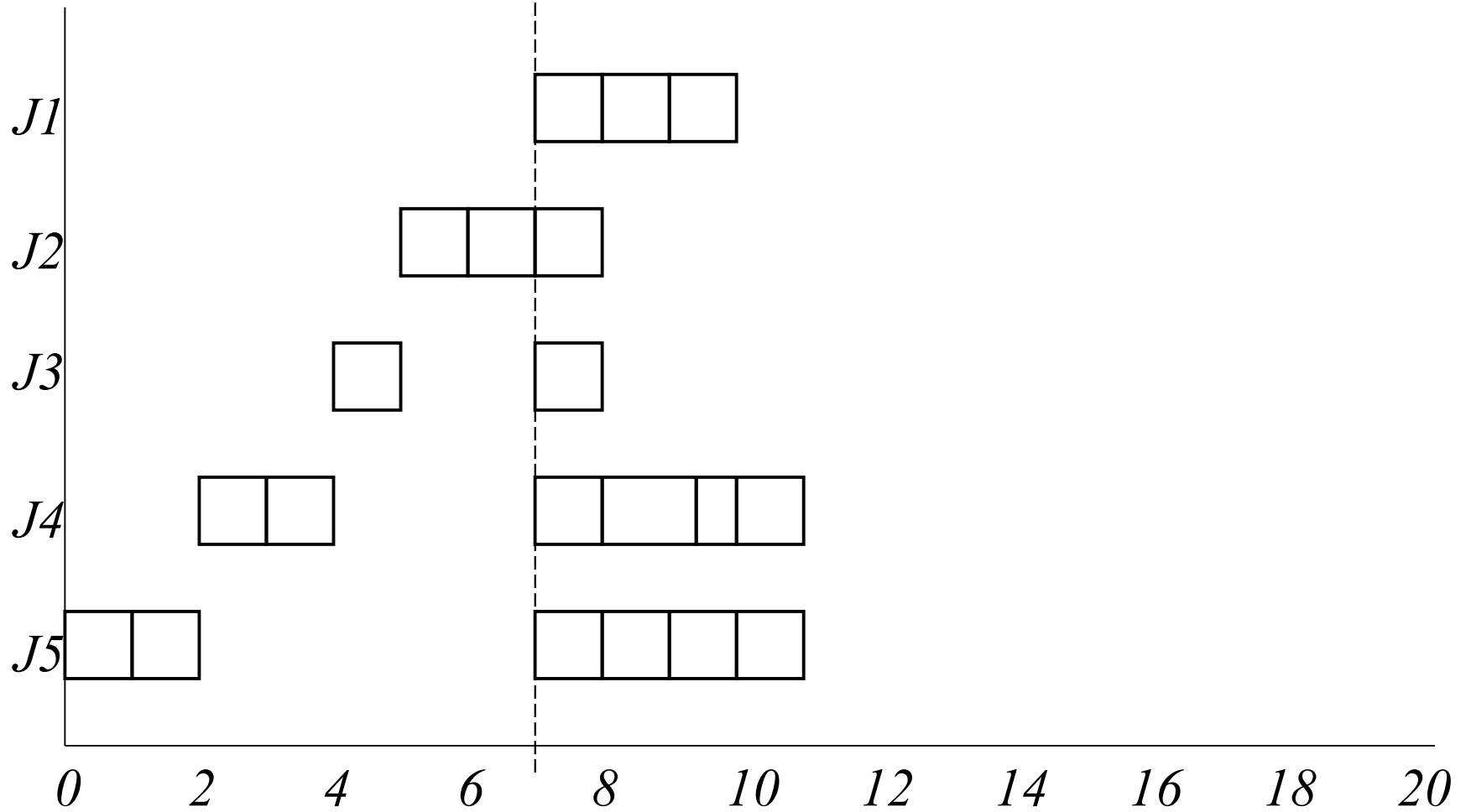

Example

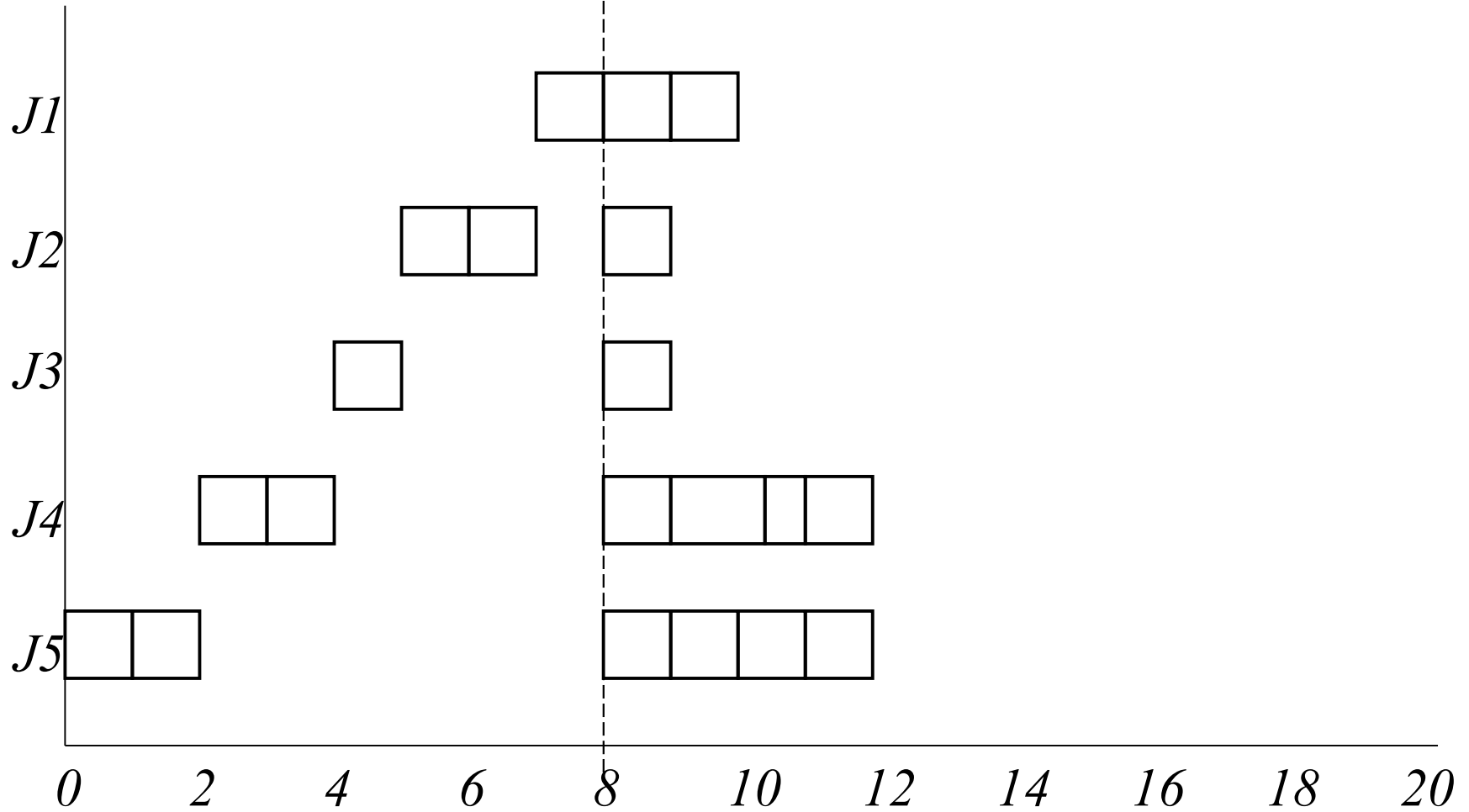

Example

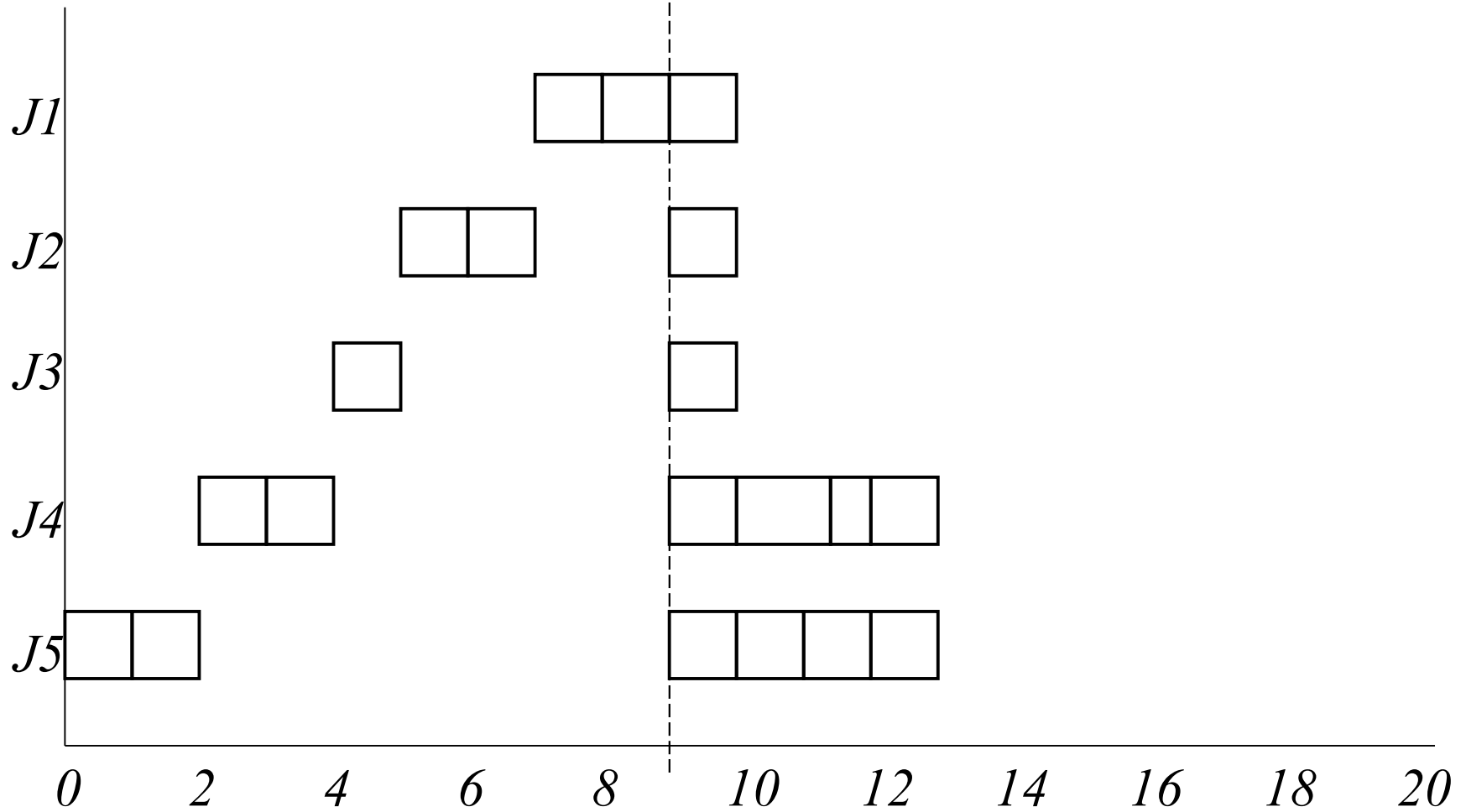

Example

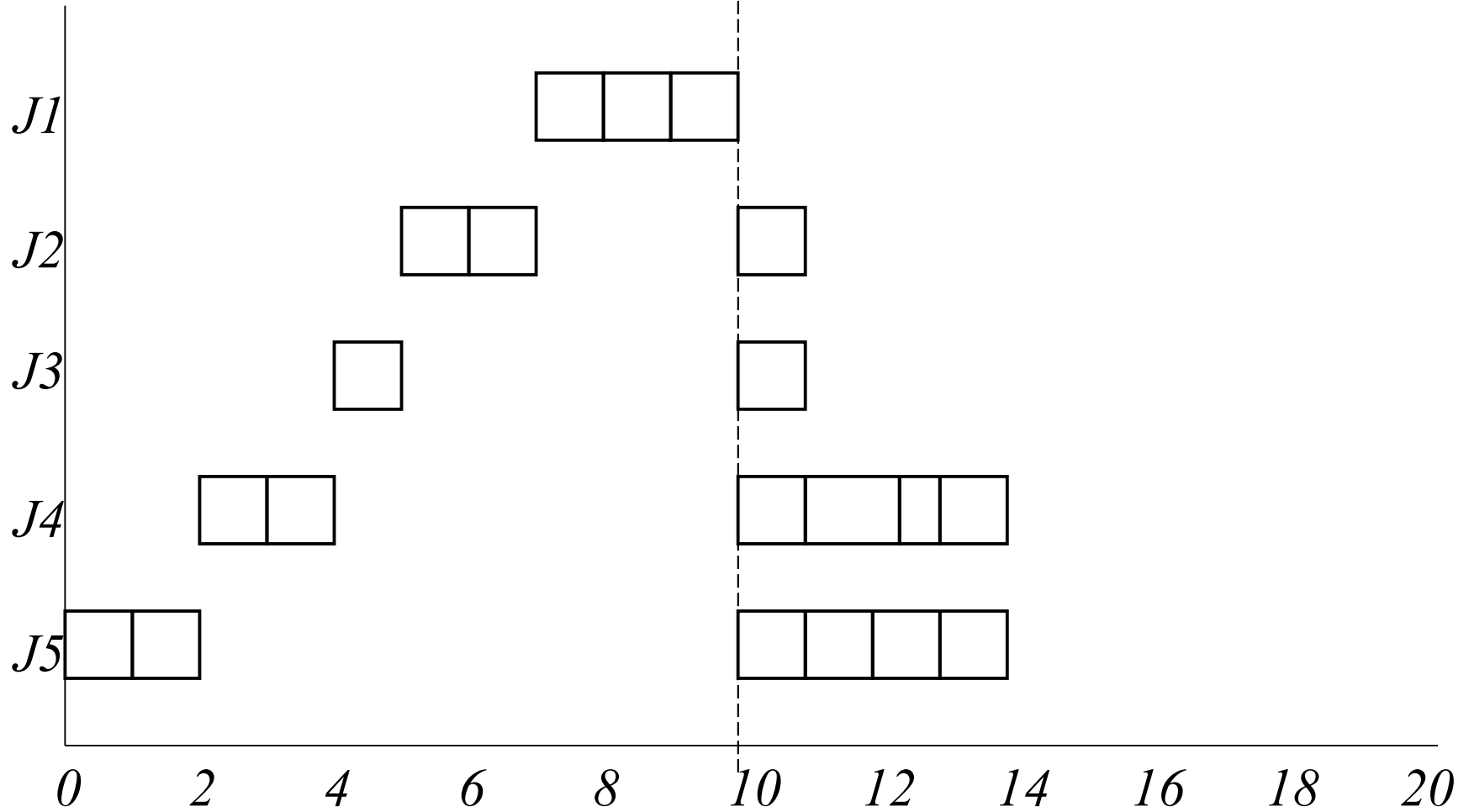

Example

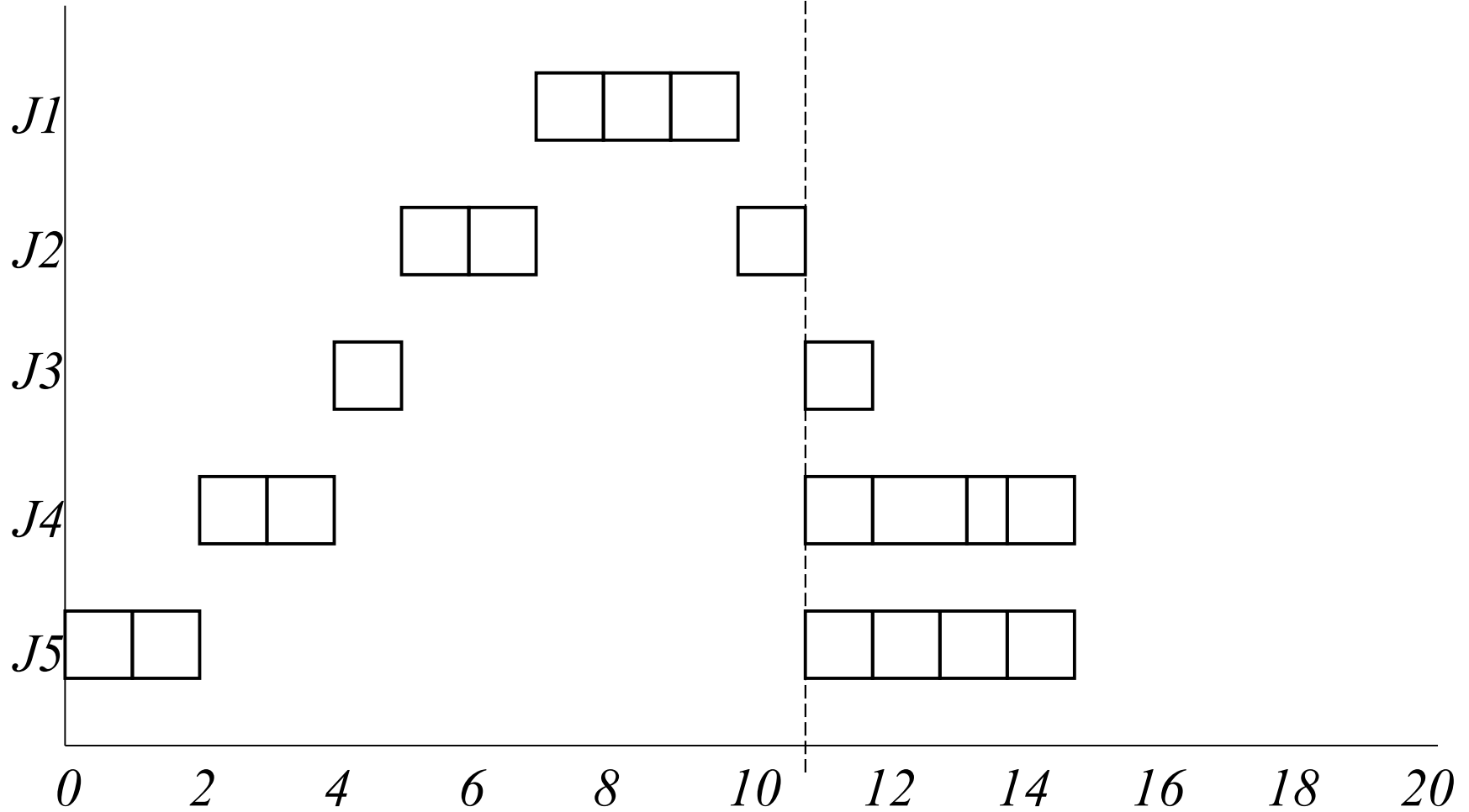

Example

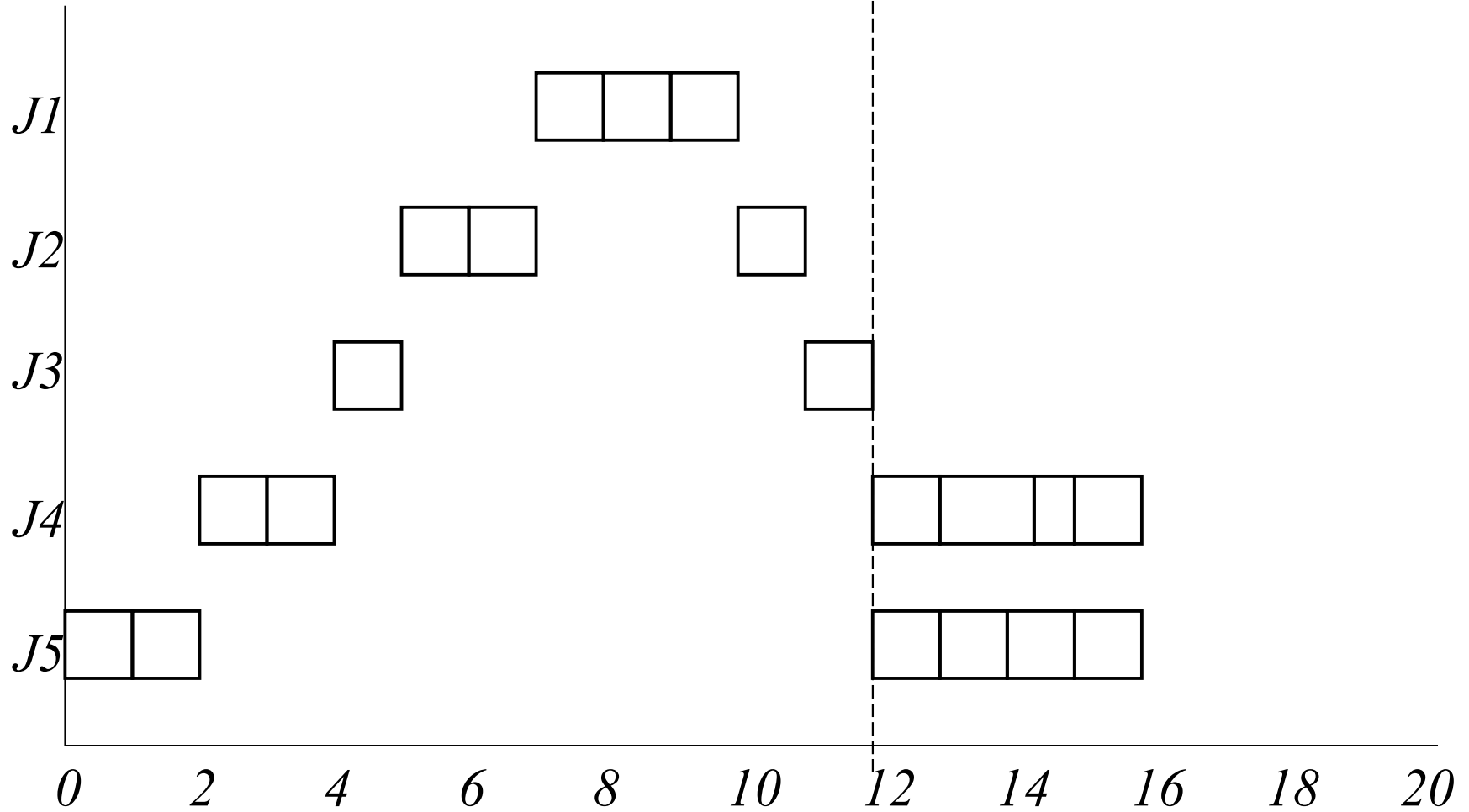

Example

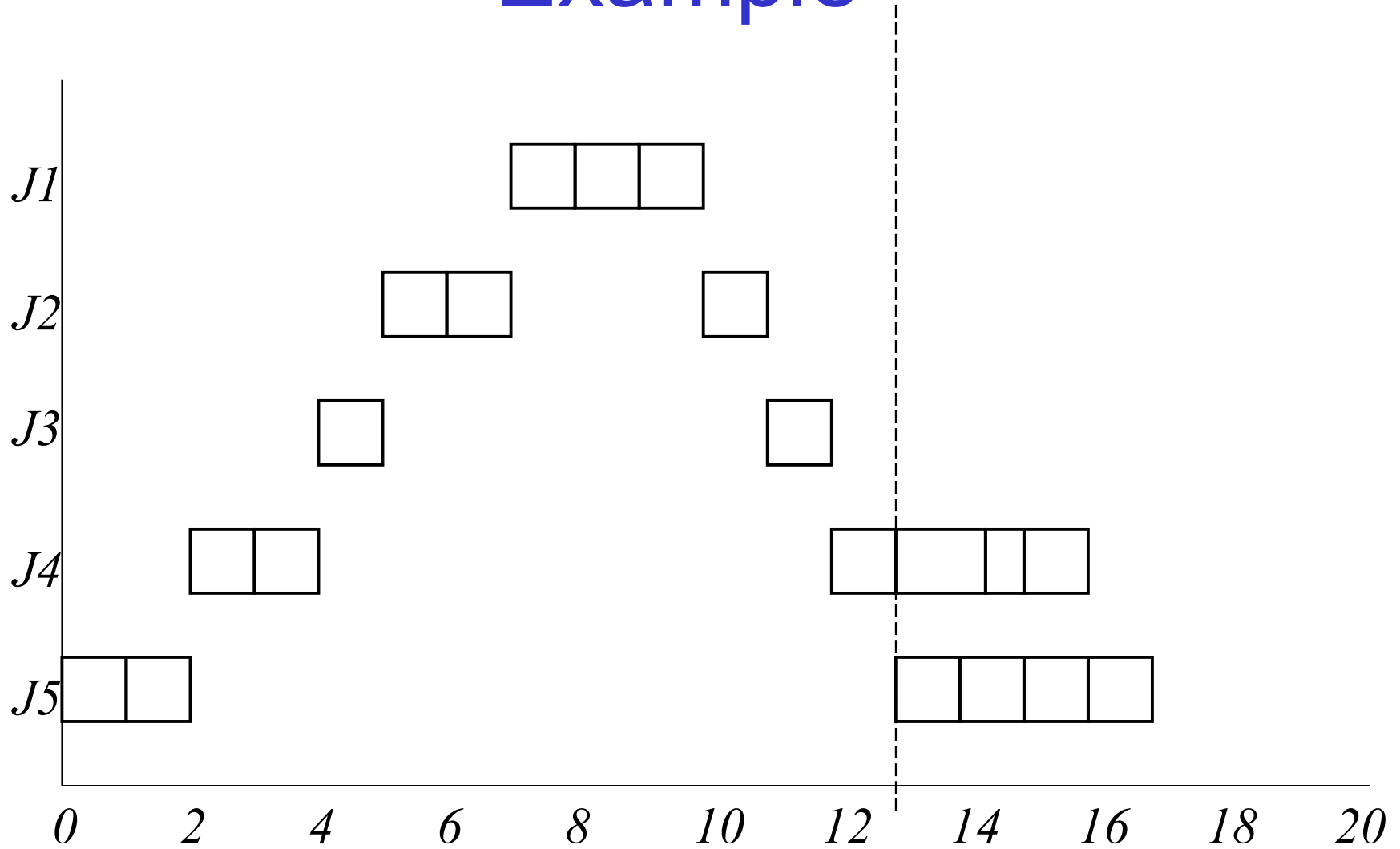

Example

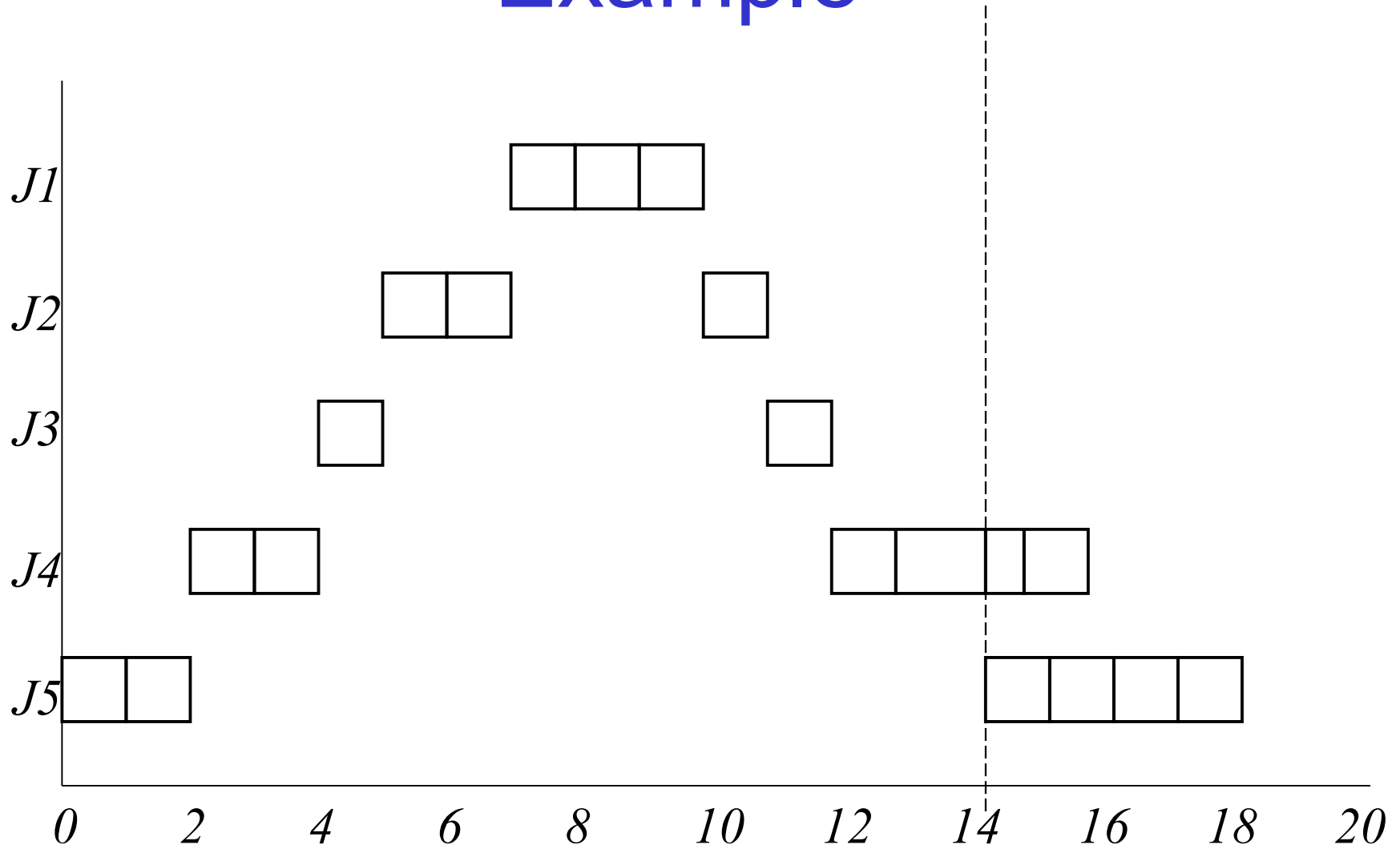

Example

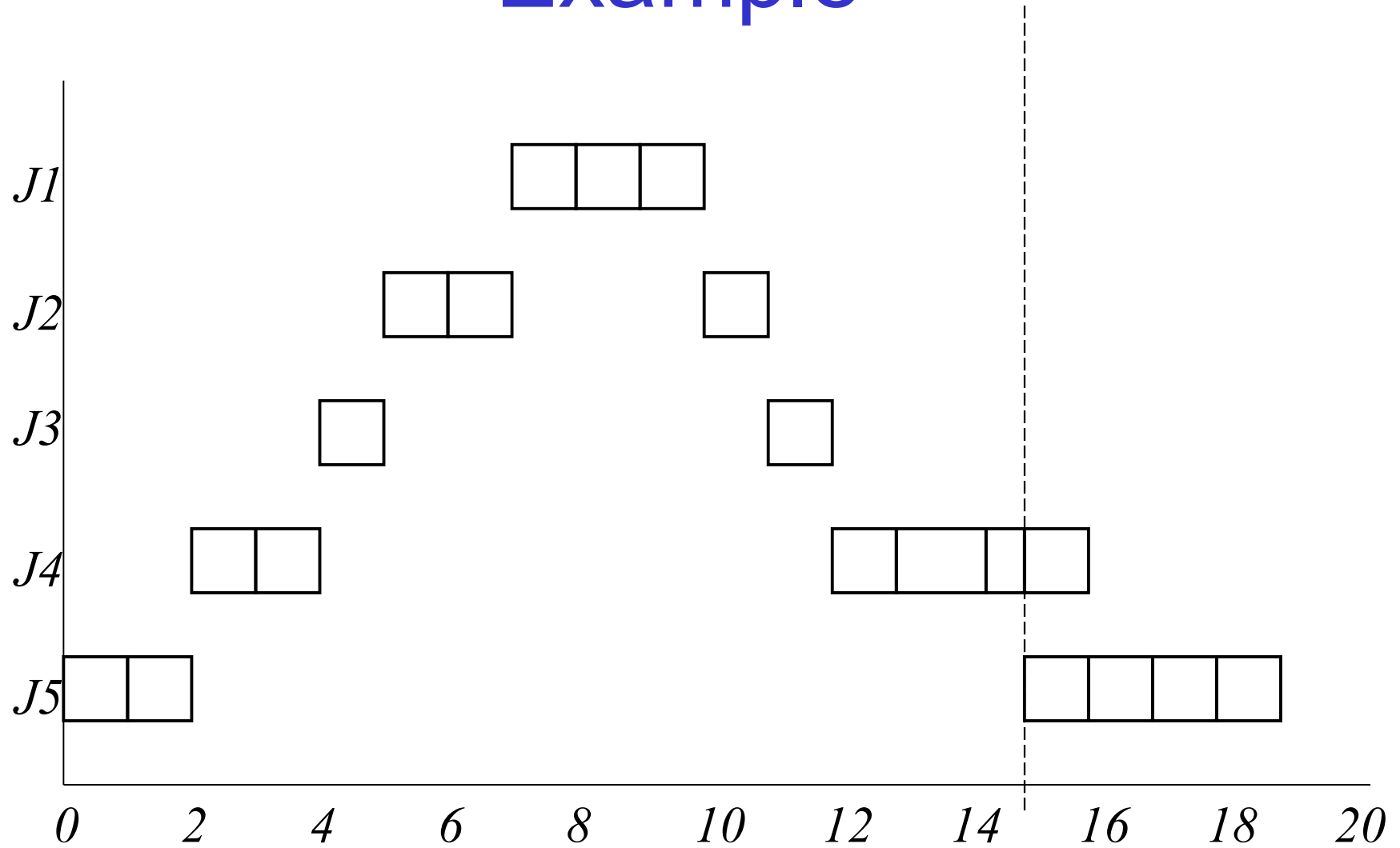

Example

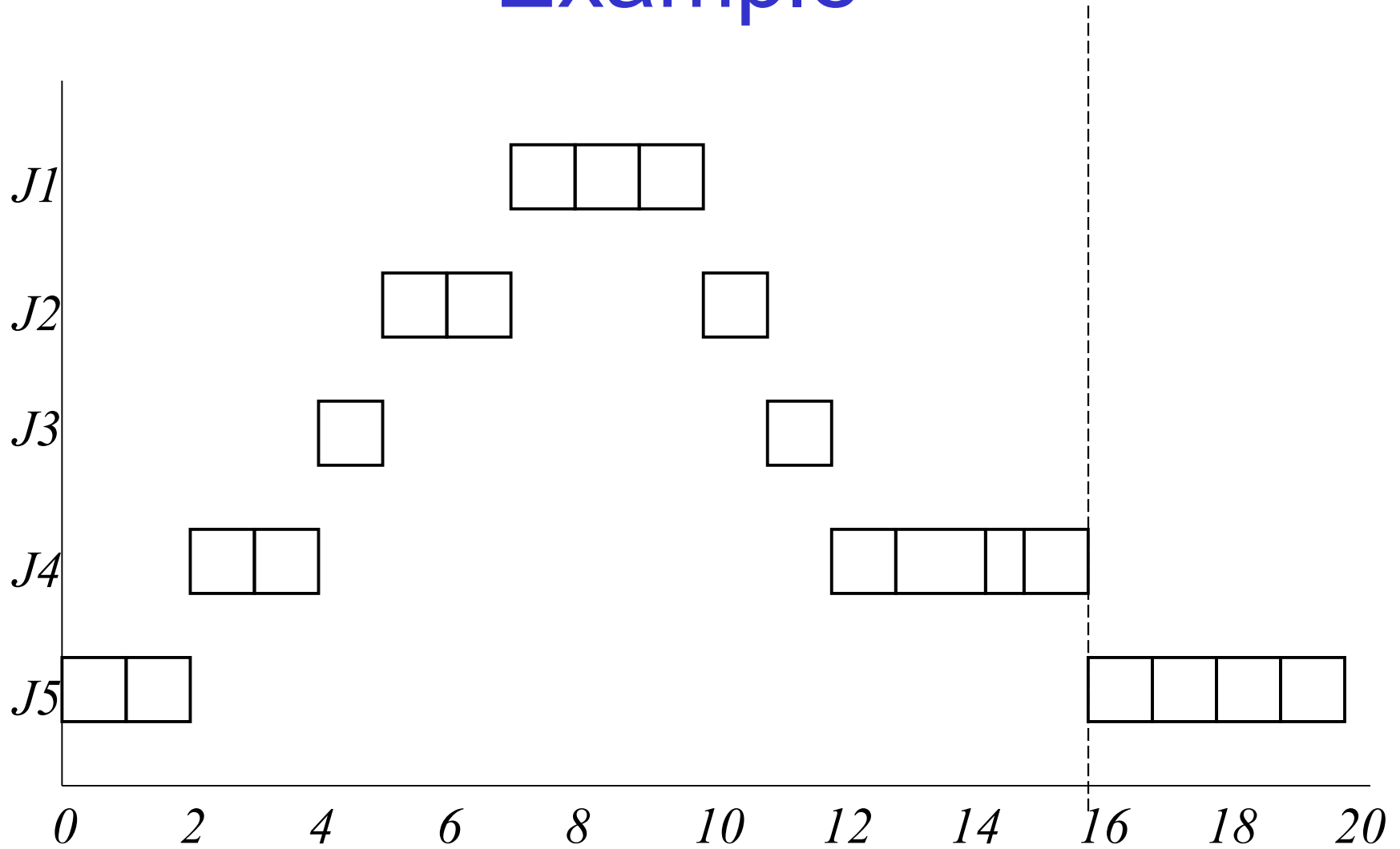

Example

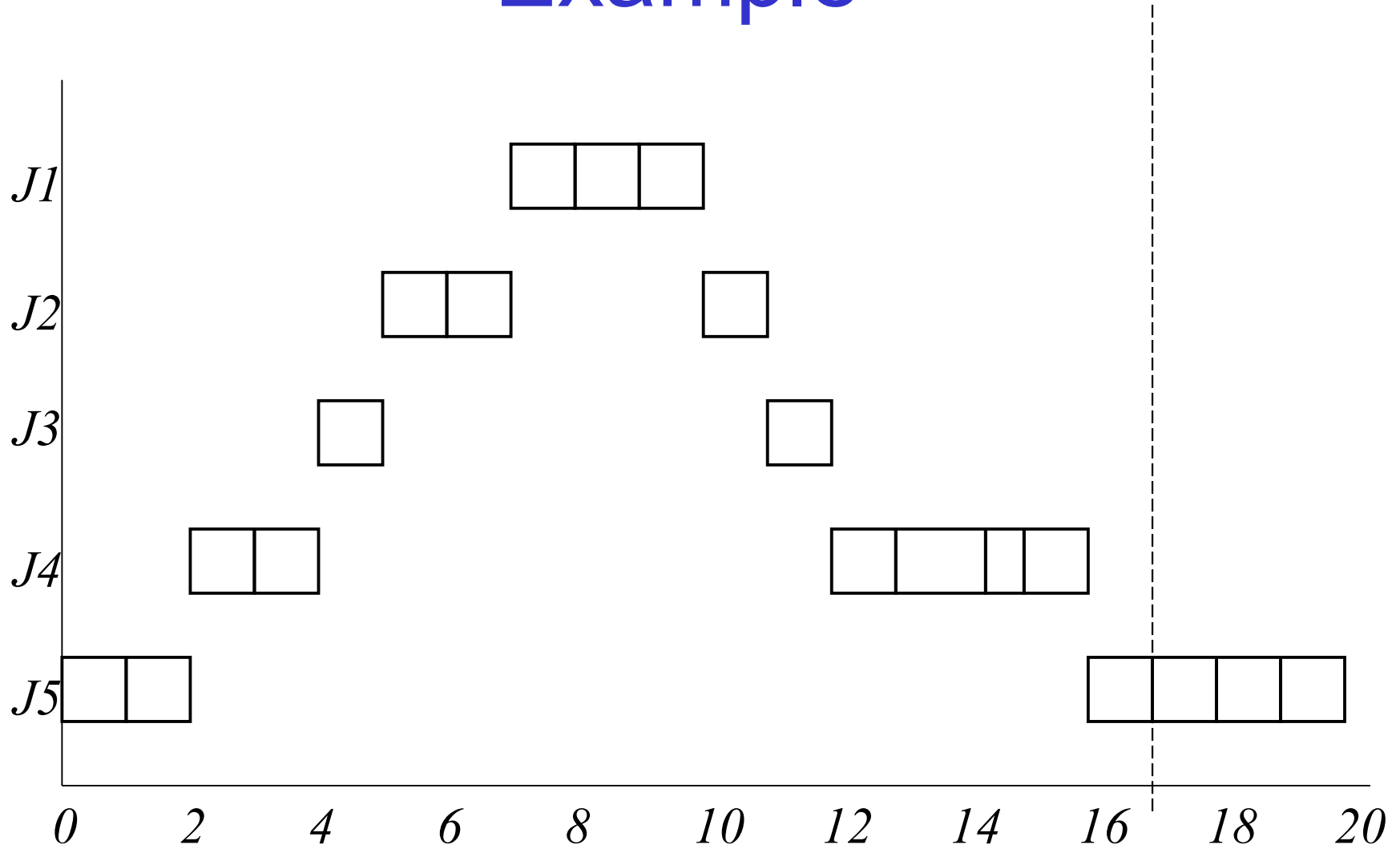

Example

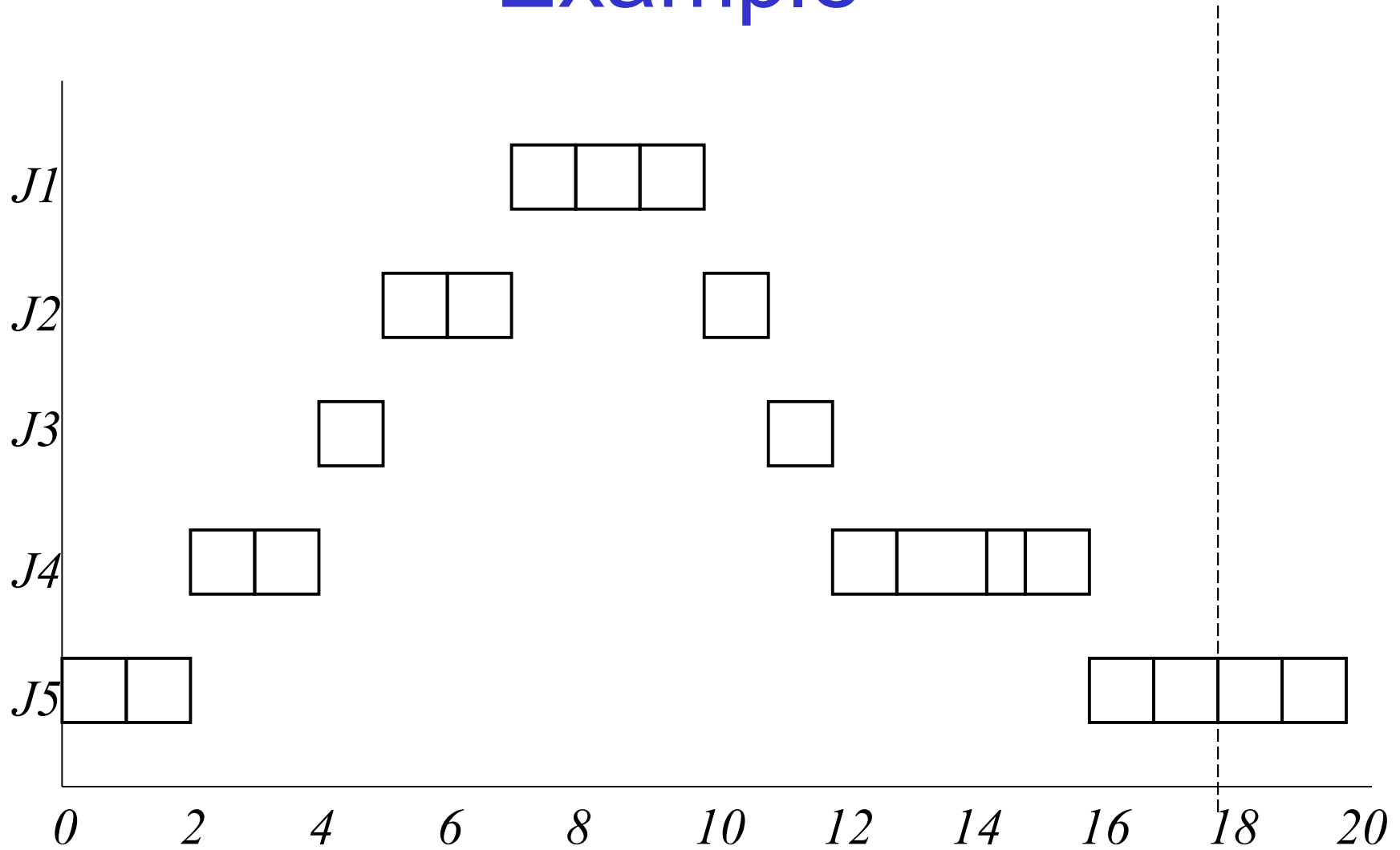

Example

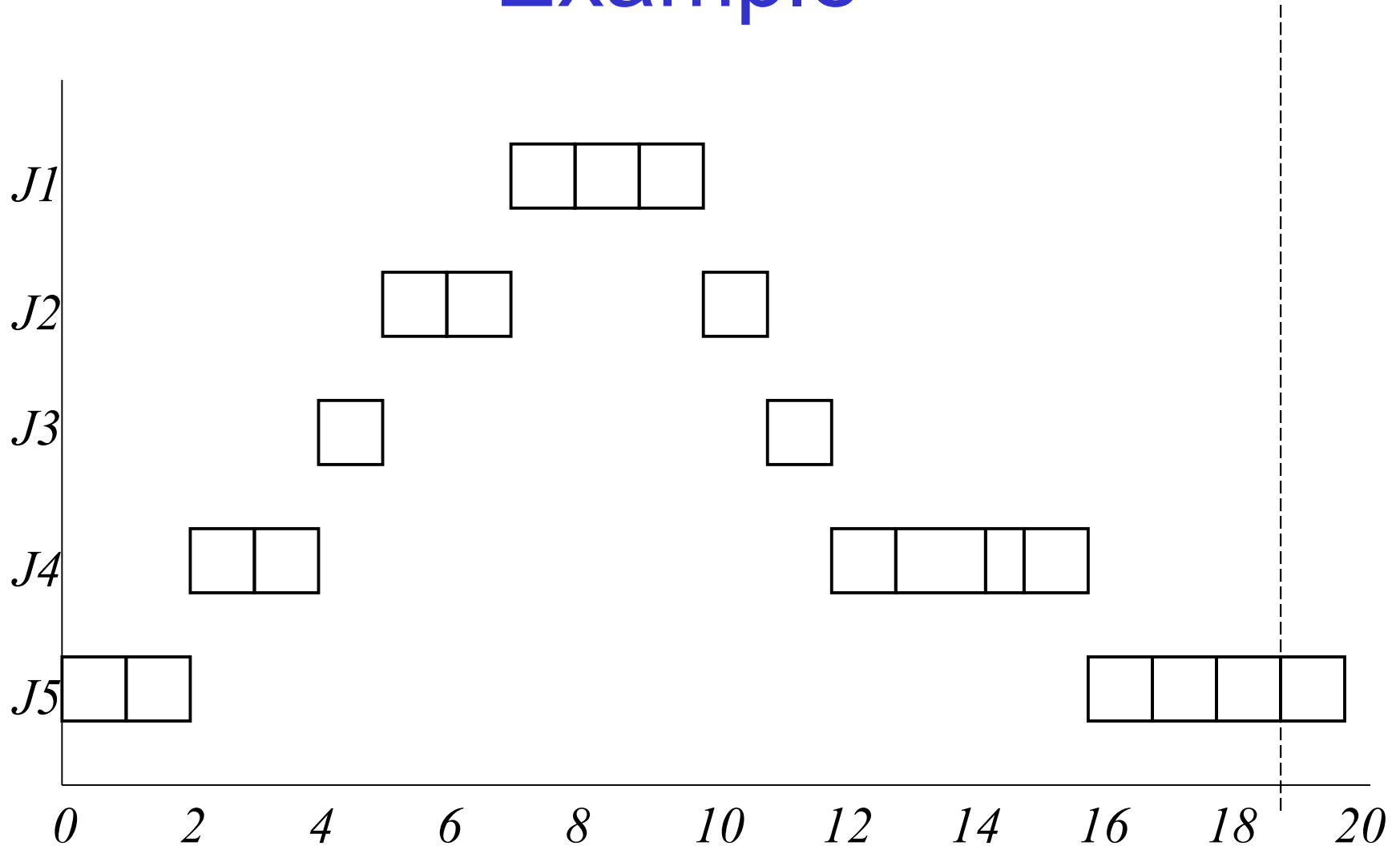

Example

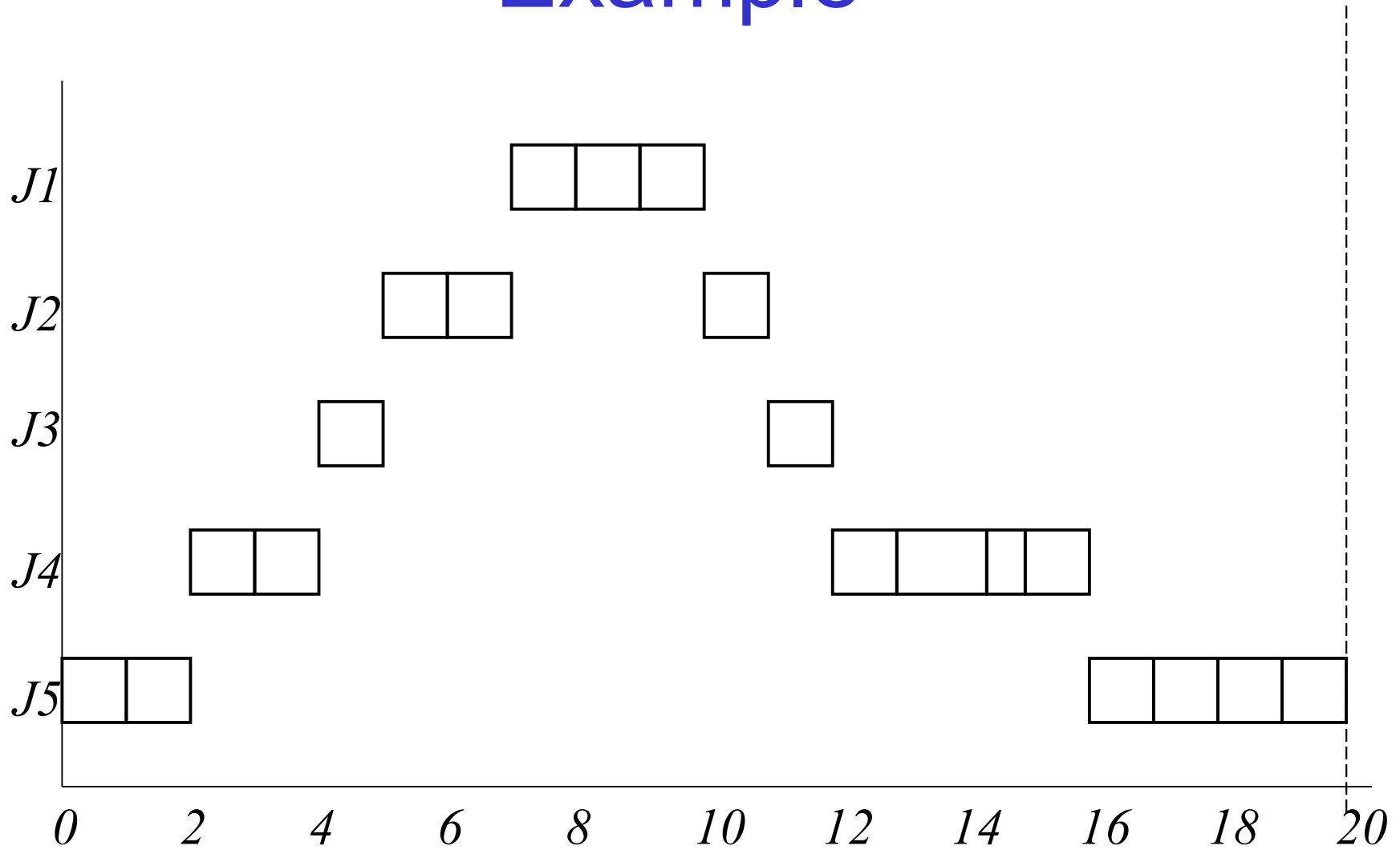

Priorities

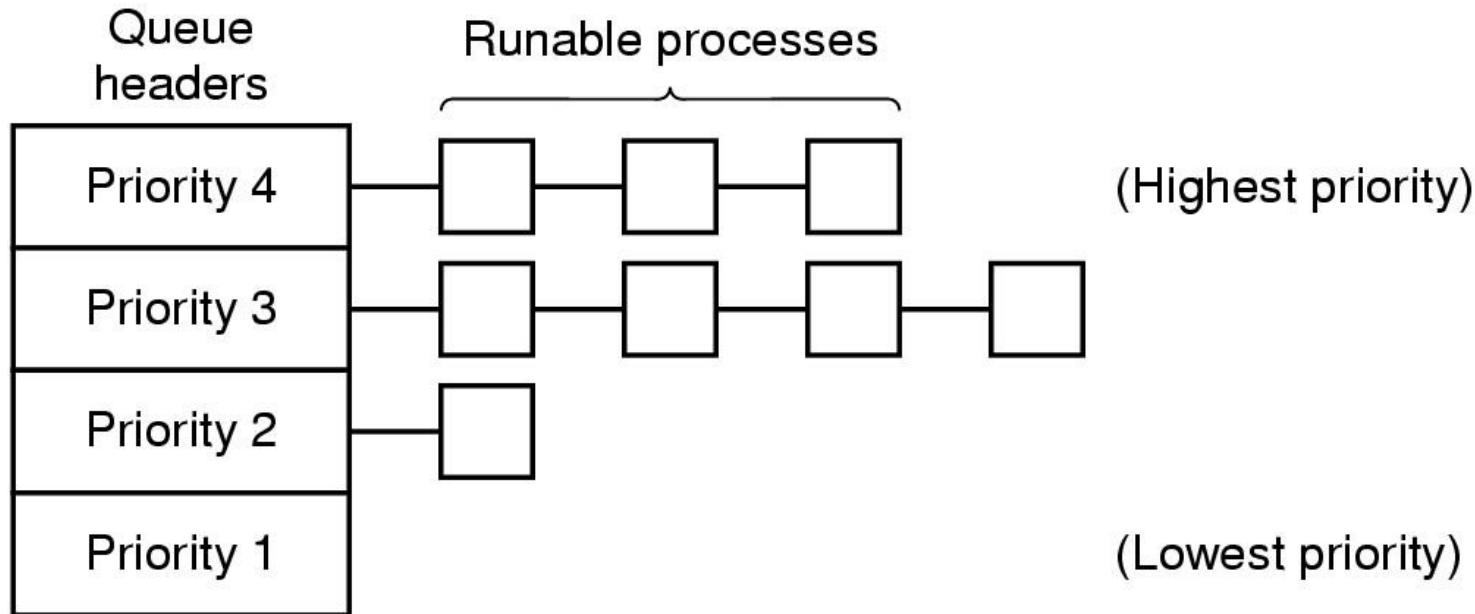

- Usually implemented by multiple priority queues, with round robin on each queue
- Con
 - Low priorities can starve
 - Need to adapt priorities periodically
 - Based on ageing or execution history



Traditional UNIX Scheduler

- Two-level scheduler
 - High-level scheduler schedules processes between memory and disk
 - Low-level scheduler is CPU scheduler
 - Based on a multi-level queue structure with round robin at each level

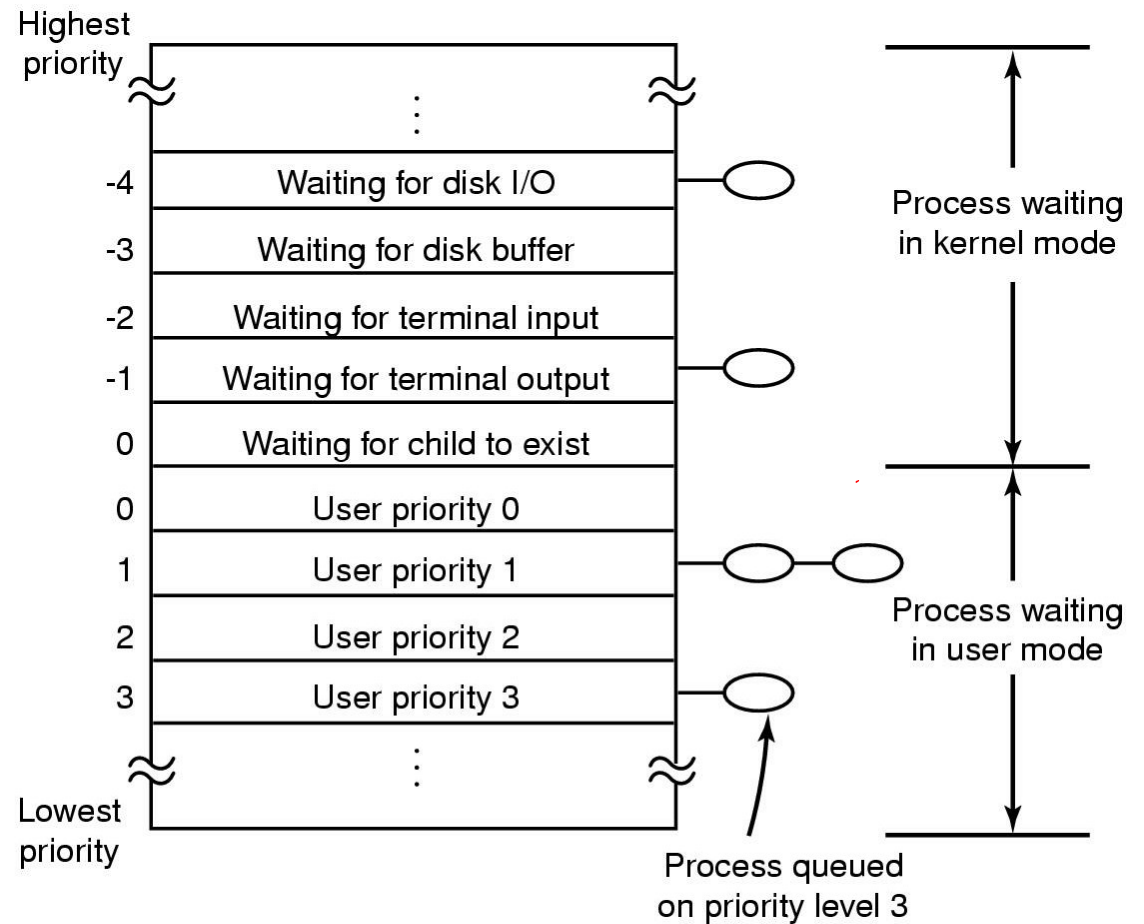

Traditional UNIX Scheduler

- The highest priority (lower number) is scheduled
- Priorities are re-calculated once per second, and re-inserted in appropriate queue
 - Avoid starvation of low priority threads
 - Penalise CPU-bound threads

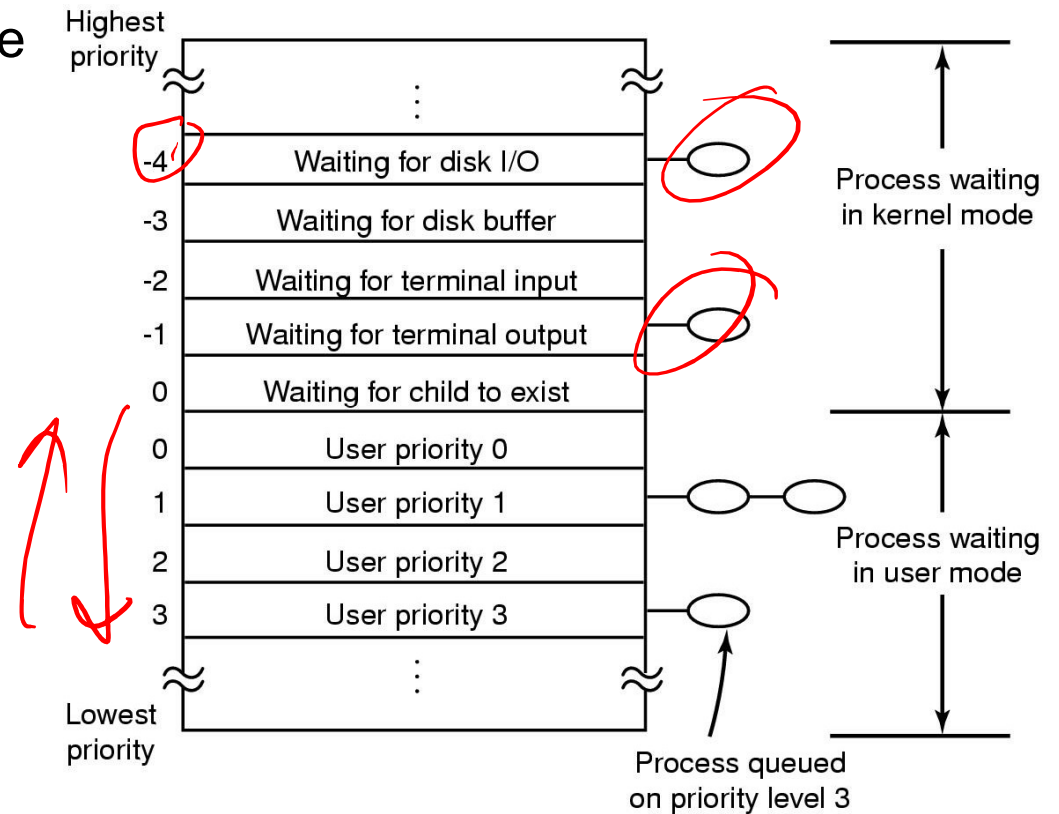

Traditional UNIX Scheduler

- $Priority = CPU_usage + nice + base$
 - CPU_usage = number of clock ticks
 - Decays over time to avoid permanently penalising the process
 - *Nice* is a value given to the process by a user to permanently boost or reduce its priority
 - Reduce priority of background jobs
 - *Base* is a set of hardwired, negative values used to boost priority of I/O bound system activities
 - Swapper, disk I/O, Character I/O

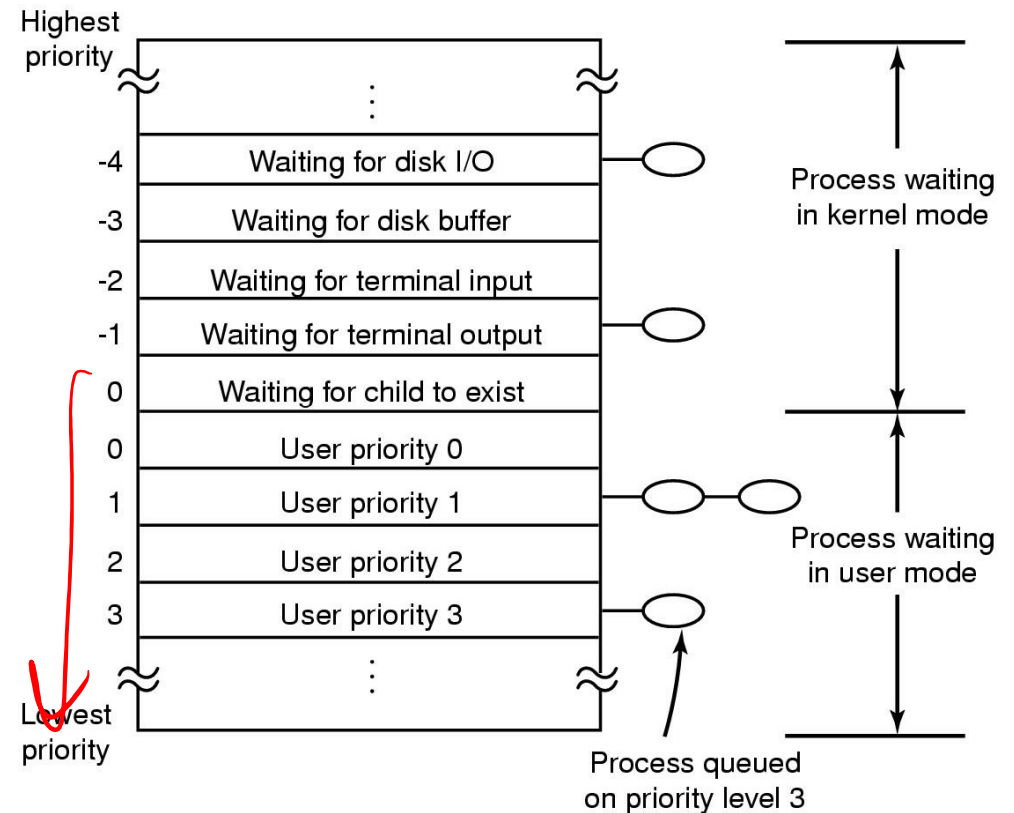

Multiprocessor Scheduling

- Given X processes (or threads) and Y CPUs,
 - how do we allocate them to the CPUs



A Single Shared Ready Queue

- When a CPU goes idle, it take the highest priority process from the shared ready queue

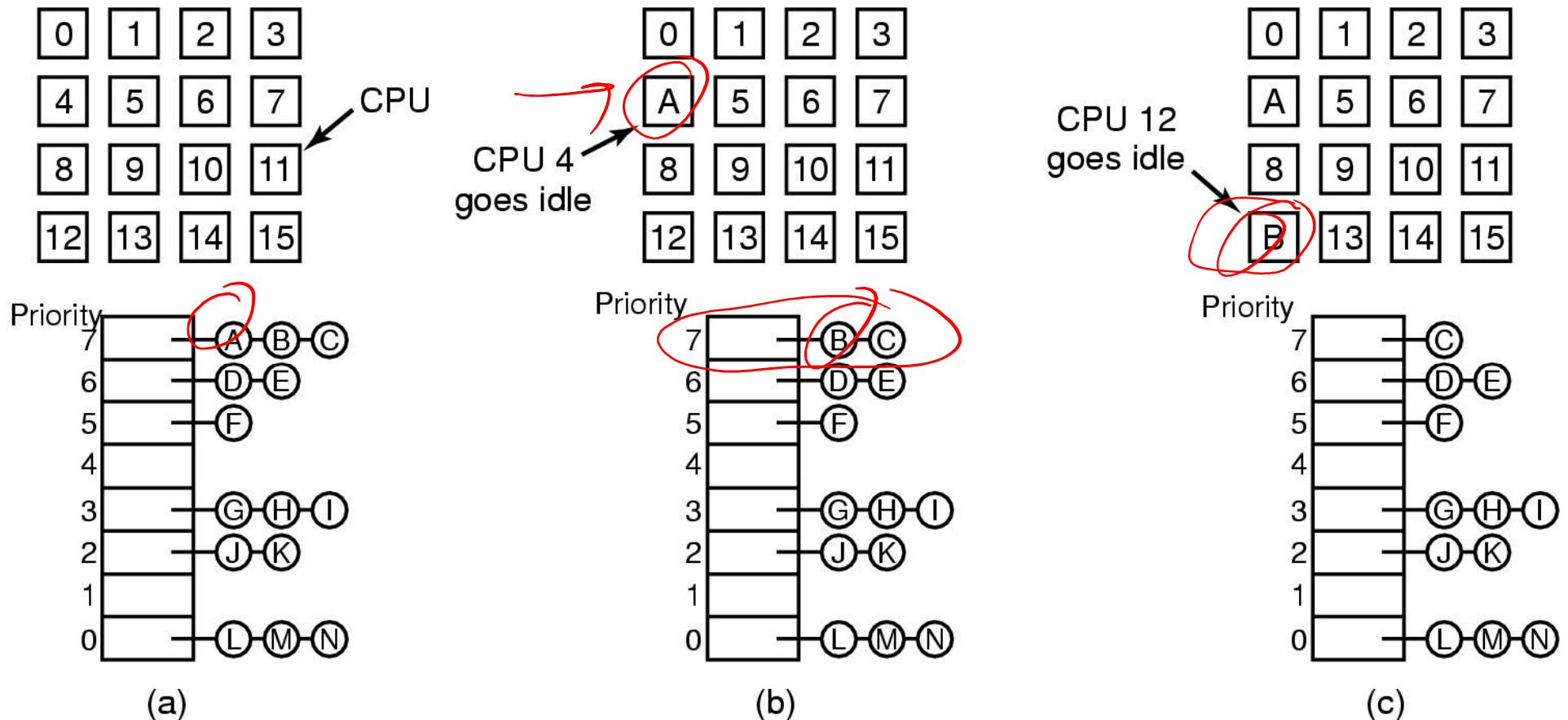

Single Shared Ready Queue

- Pros

- Simple
- Automatic load balancing

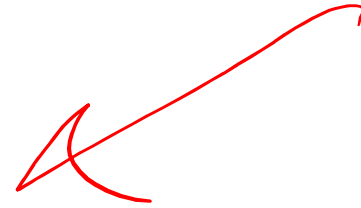

- Cons

- Lock contention on the ready queue can be a major bottleneck
 - Due to frequent scheduling or many CPUs or both
- Not all CPUs are equal
 - The last CPU a process ran on is likely to have more related entries in the cache.



Affinity Scheduling

- Basic Idea
 - Try hard to run a process on the CPU it ran on last time
- One approach: *Multiple Queue Multiprocessor Scheduling*



Multiple Queue SMP Scheduling

- Each CPU has its own ready queue
- Coarse-grained algorithm assigns processes to CPUs
 - Defines their affinity, and roughly balances the load
- The bottom-level fine-grained scheduler:
 - Is the frequently invoked scheduler (e.g. on blocking on I/O, a lock, or exhausting a timeslice)
 - Runs on each CPU and selects from its own ready queue
 - Ensures affinity
 - If nothing is available from the local ready queue, it runs a process from another CPU's ready queue rather than go idle
 - Termed “Work stealing”



Multiple Queue SMP Scheduling

- Pros
 - No lock contention on per-CPU ready queues in the (hopefully) common case
 - Load balancing to avoid idle queues
 - Automatic affinity to a single CPU for more cache friendly behaviour

