

Computer Hardware Review (Memory Hierarchy)

Chapter 1.4



1

Learning Outcomes

- Understand the concepts of memory hierarchy and caching, and how they affect performance.



2

Operating Systems

- Exploit the hardware available
- Provide a set of high-level services that represent or are implemented by the hardware.
- Manages the hardware reliably and efficiently
- *Understanding operating systems requires a basic understanding of the underlying hardware*



3

Memory Hierarchy

- Going down the hierarchy
 - Decreasing cost per bit
 - Increasing capacity
 - Increasing access time
- Decreasing frequency of access to the memory by the processor
 - Hopefully
 - Principle of locality!!!!

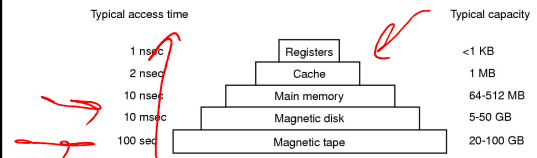

4

Caching as a general technique

- Given two-levels of data storage: small and fast, versus large and slow,
- Can speed access to slower storage by using intermediate-speed storage as a cache.



5

A hardware approach to improving system performance?

CPU Registers
Fast

Cache Memory (SRAM)
Fast

Main Memory (DRAM)
Slow

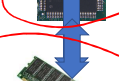
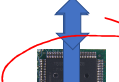
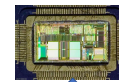

6

CPU Cache

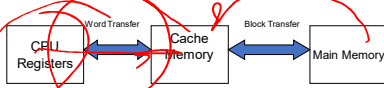

- CPU cache is fast memory placed between the CPU and main memory
 - 1 to a few cycles access time compared to RAM access time of tens – hundreds of cycles
- Holds recently used data or instructions to save memory accesses.
- Matches slow RAM access time to CPU speed if high hit rate
- Is hardware maintained and (mostly) transparent to software
- Sizes range from few kB to tens of MB.
- Usually a hierarchy of caches (2–5 levels), on- and off-chip.

Performance

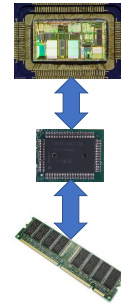

- What is the effective access time of memory subsystem?
- Answer: It depends on the hit rate in the first level.

Effective Access Time

$$T_{eff} = H \times T_1 + (1 - H) \times T_2$$

T_1 = access time of memory 1
 T_2 = access time of memory 2
 H = hit rate in memory 1
 T_{eff} = effective access time of system

Example

- Cache memory access time 1ns
- Main memory access time 10ns
- Hit rate of 95%

$$T_{eff} = 0.95 \times 10^{-9} + (1 - 0.95) \times (10^{-9} + 10 \times 10^{-9}) = 1.5 \times 10^{-9}$$

Moving-Head Disk Mechanism

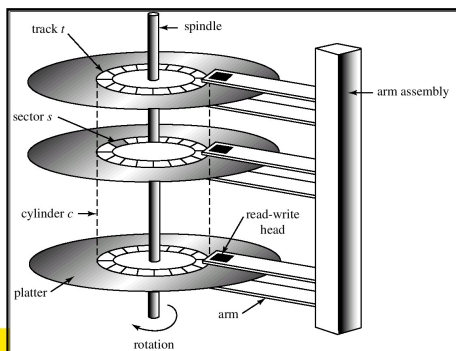

Example Disk Access Times

- Disk can read/write data relatively fast
 - 15,000 rpm drive - 80 MB/sec
 - 1 KB block is read in 12 microseconds
- Access time dominated by time to locate the head over data
 - Rotational latency
 - Half one rotation is 2 milliseconds
 - Seek time
 - Full inside to outside is 8 milliseconds
 - Track to track .5 milliseconds
- 2 milliseconds is 164KB in "lost bandwidth"

A OS approach to improving system performance?

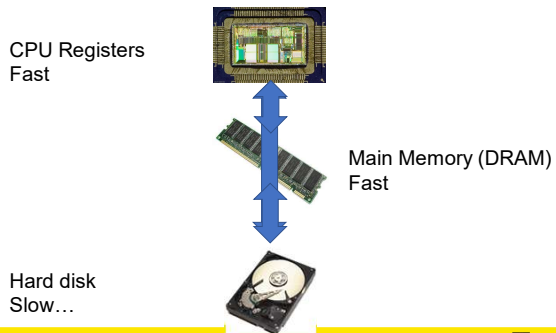

13

A Strategy: Avoid Waiting for Disk Access

- Keep a subset of the disk's data in main memory
- ⇒ OS uses main memory as a *cache* of disk contents

14

Application approach to improving system performance

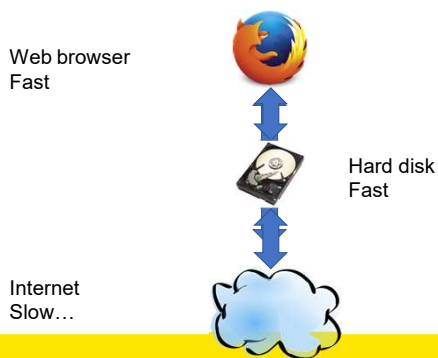

15

A Strategy: Avoid Waiting for Internet Access

- Keep a subset of the Internet's data on disk
- ⇒ Application uses disk as a *cache* of the Internet

16