

Introduction to Operating Systems

Chapter 1 – 1.3

Chapter 1.5 – 1.9



Learning Outcomes

- High-level understand what is an operating system and the role it plays
- A high-level understanding of the structure of operating systems, applications, and the relationship between them.
- Some knowledge of the services provided by operating systems.
- Exposure to some details of major OS concepts.



What is an Operating System?

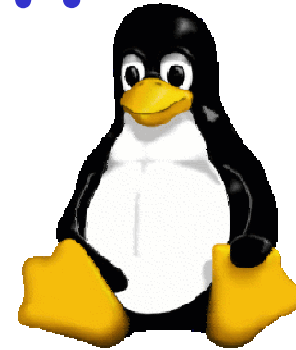

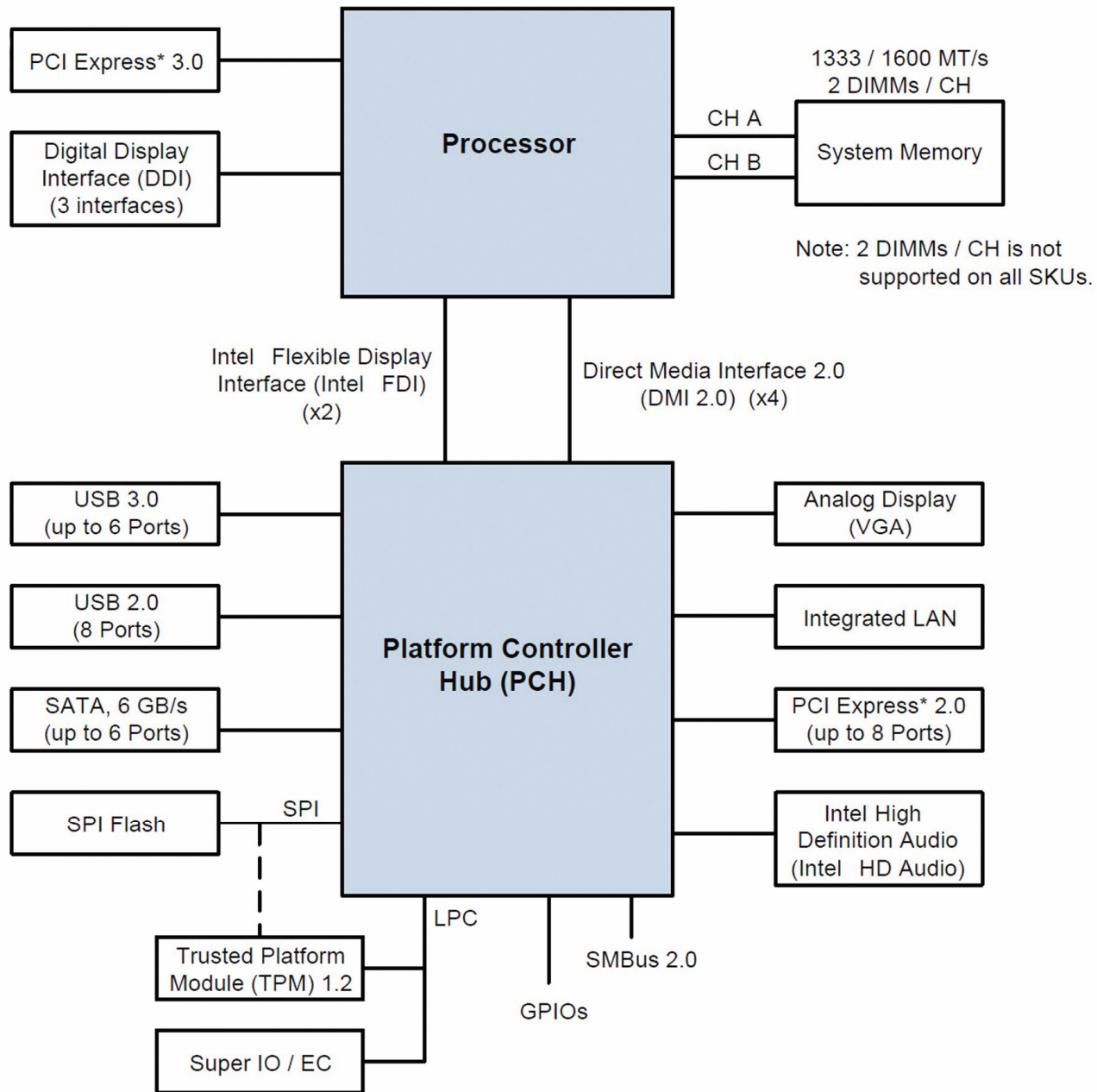

Viewing the Operating System as an Abstract Machine

- Extends the basic hardware with added functionality
- Provides high-level abstractions
 - More programmer friendly
 - Common core for all applications
- It hides the details of the hardware
 - Makes application code portable



Disk

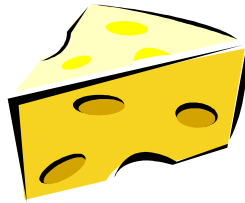

Memory

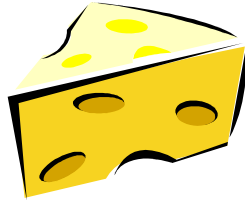

CPU

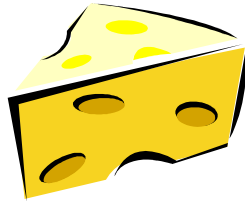

Network

Bandwidth

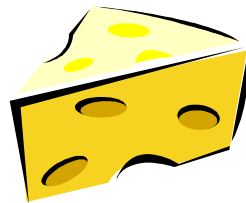

Users



Viewing the Operating System as a Resource Manager

- Responsible for allocating resources to users and processes
- Must ensure
 - No Starvation
 - Progress
 - Allocation is according to some desired policy
 - First-come, first-served; Fair share; Weighted fair share; limits (quotas), etc...
 - Overall, that the system is efficiently used



Structural View: the Operating System as the Privileged Component

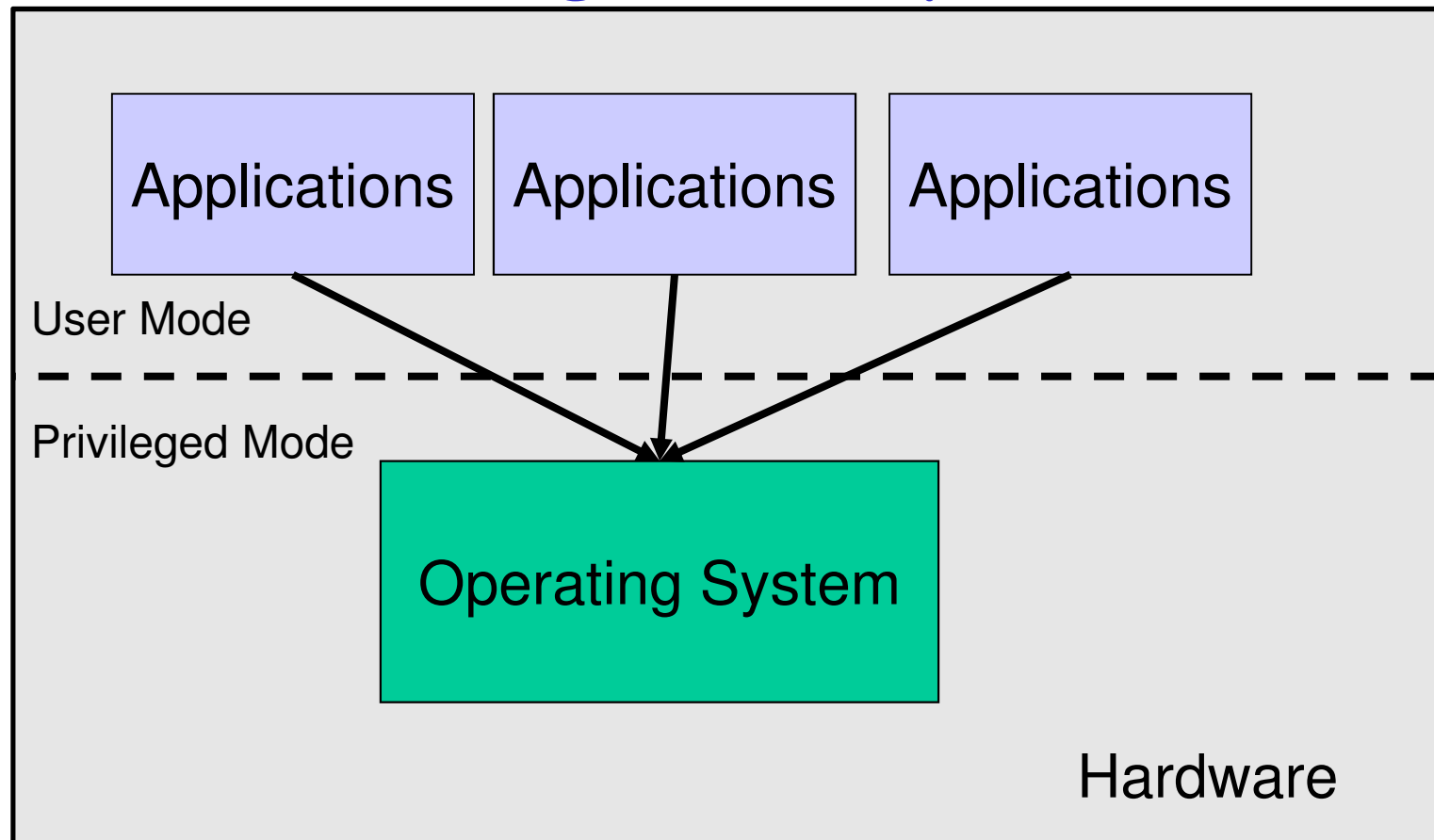

Operating System Kernel

- Portion of the operating system that is running in *privileged mode*
- Usually resident in main memory
- Contains fundamental functionality
 - Whatever is required to implement other services
 - Whatever is required to provide security
- Contains most-frequently used functions
- Also called the nucleus or supervisor



The Operating System is Privileged

- Applications should not be able to interfere or bypass the operating system
 - OS can enforce the “extended machine”
 - OS can enforce its resource allocation policies
 - Prevent applications from interfering with each other

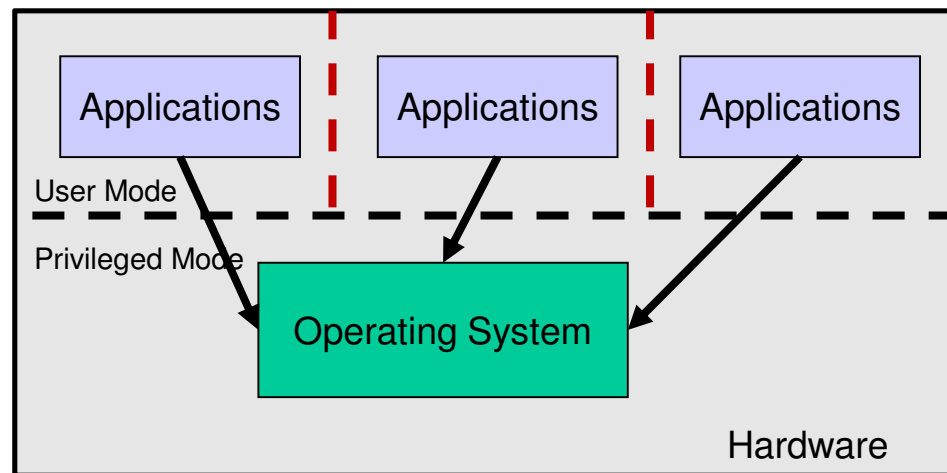

Structure of a Computer System

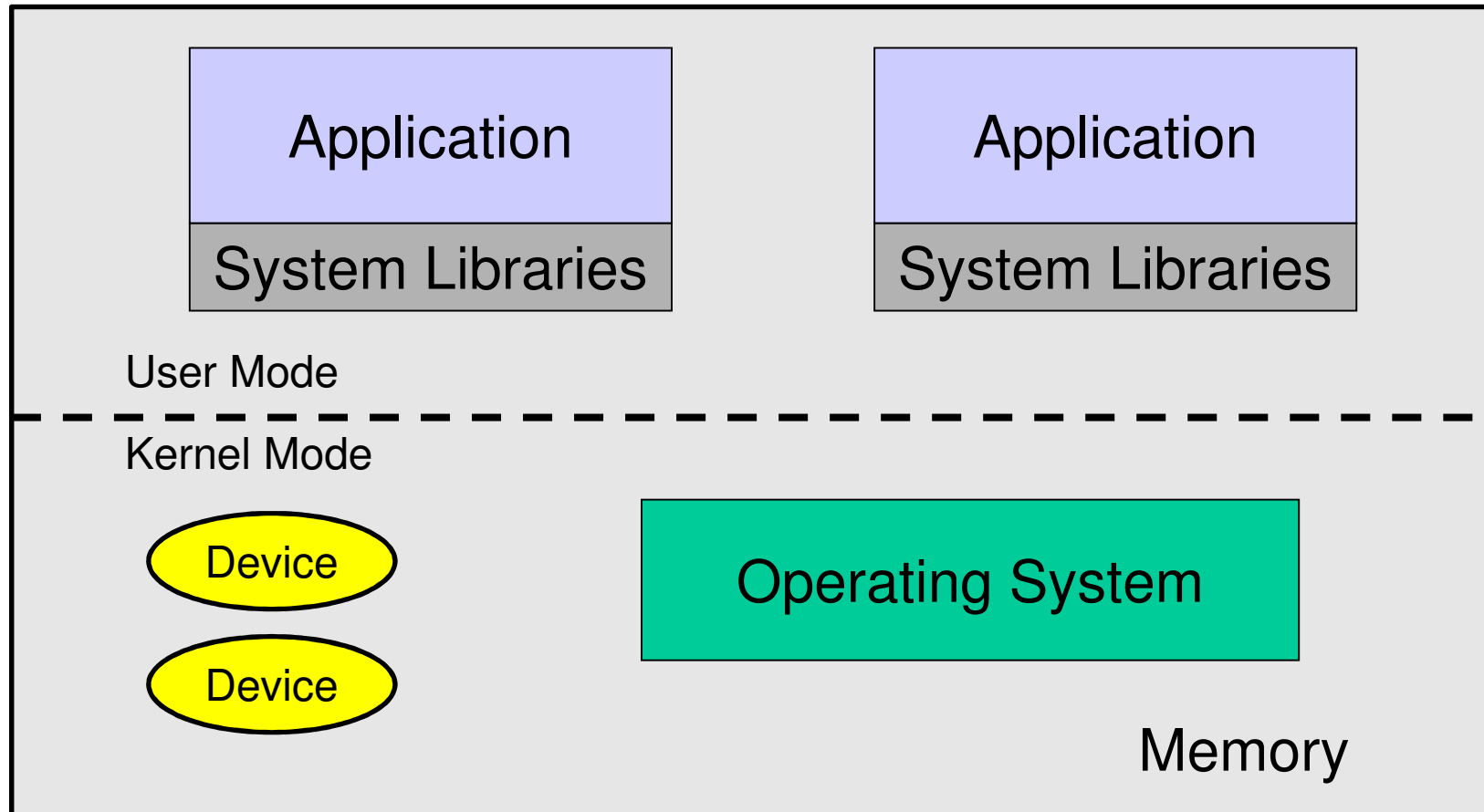

Structure of a Computer System

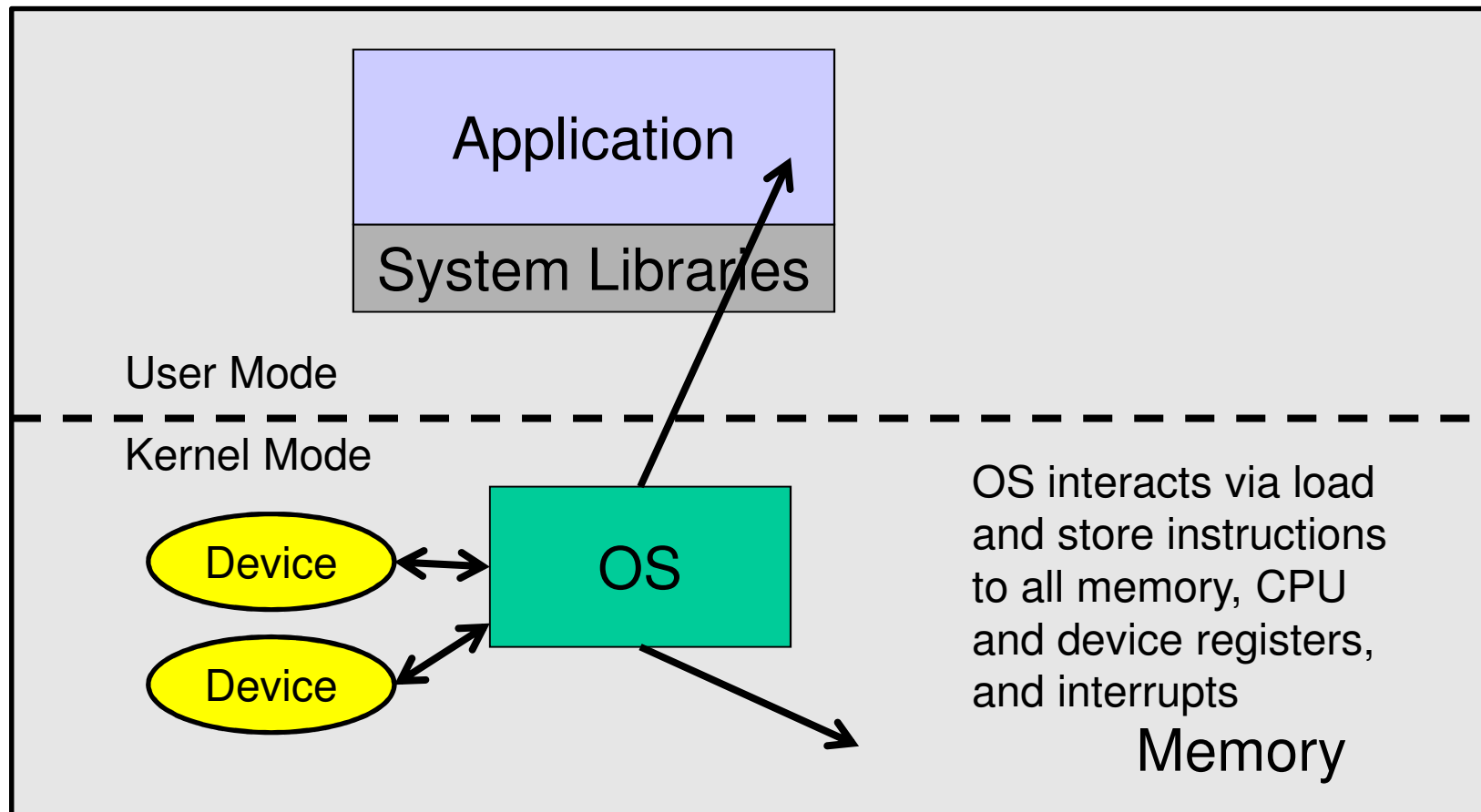

Structure of a Computer System

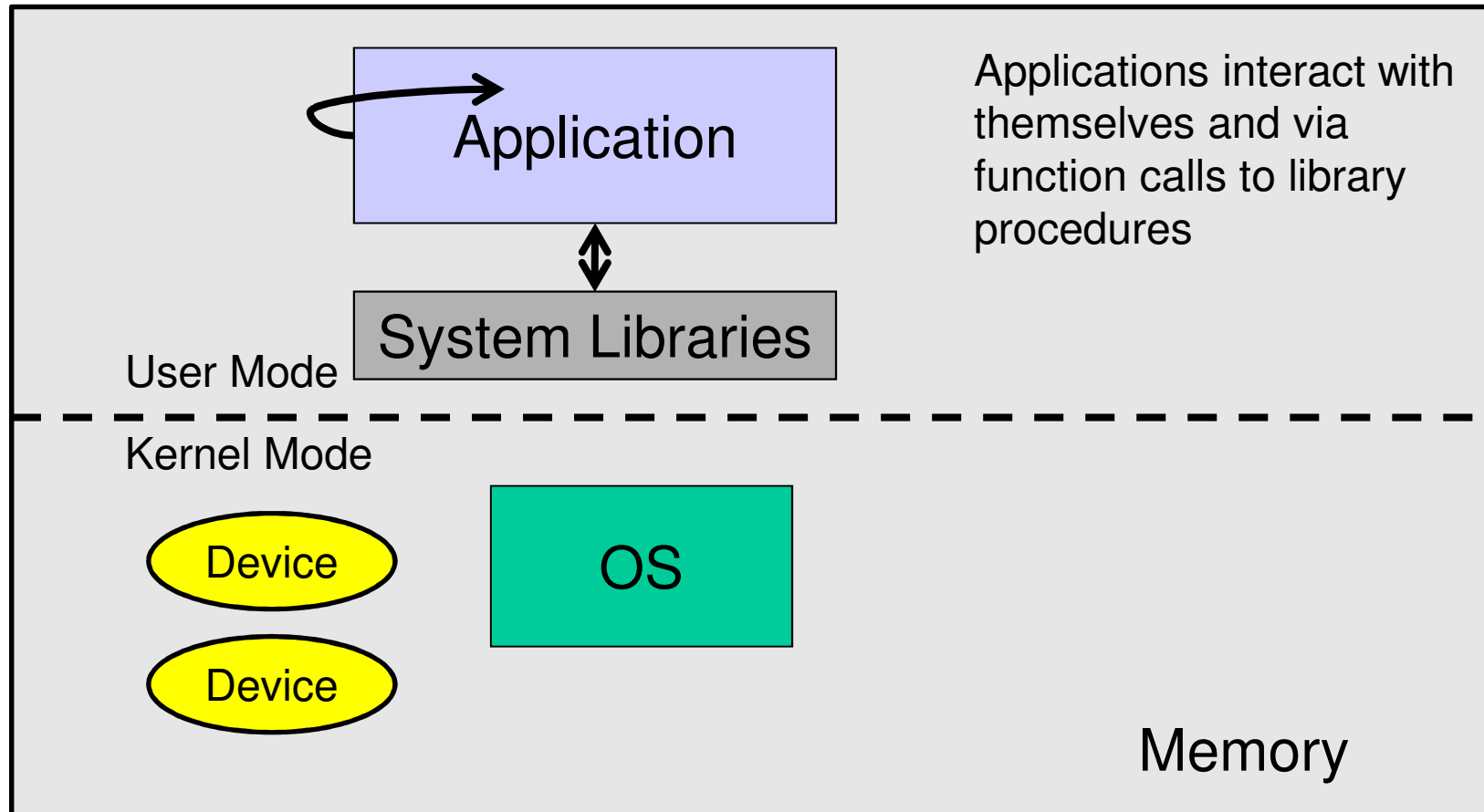

Structure of a Computer System

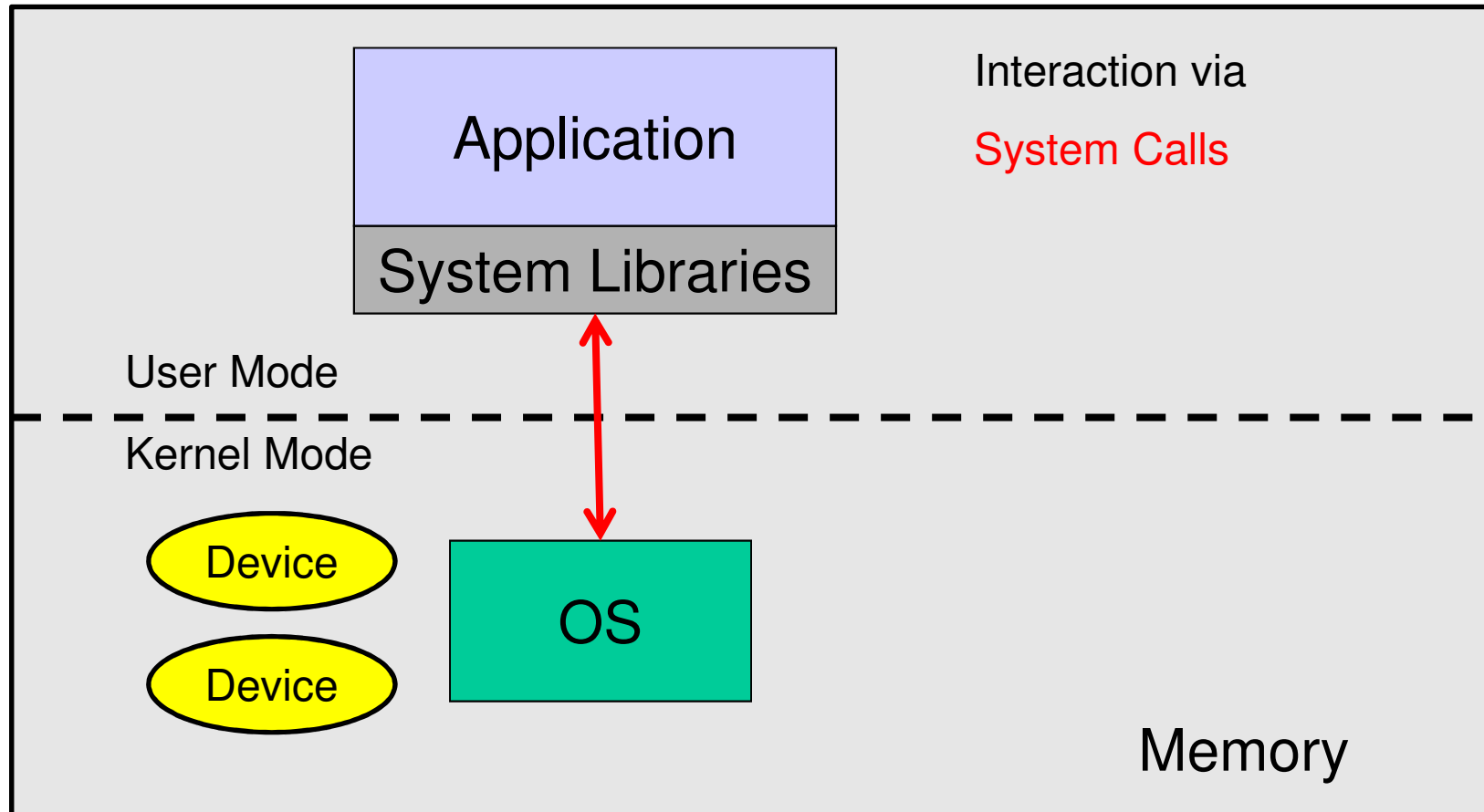

Privilege-less OS

- Some Embedded OSs have no privileged component
 - e.g. PalmOS, Mac OS 9, RTEMS
 - Can implement OS functionality, but cannot enforce it.
 - All software runs together
 - No isolation
 - One fault potentially brings down entire system

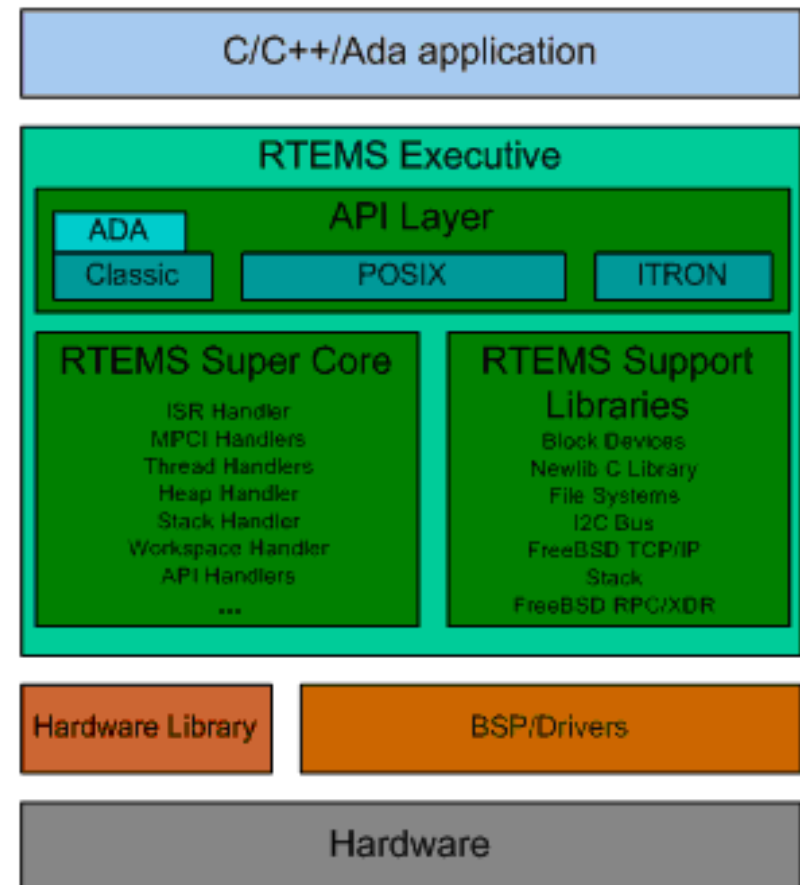

A Note on System Libraries

System libraries are just that, libraries of support functions (procedures, subroutines)

- Only a subset of library functions are actually systems calls
 - `strcmp()`, `memcpy()`, are pure library functions
 - manipulate memory within the application, or perform computation
 - `open()`, `close()`, `read()`, `write()` are system calls
 - they cross the user-kernel boundary, e.g. to read from disk device
 - Implementation mainly focused on passing request to OS and returning result to application
- System call functions are in the library for convenience
 - try `man syscalls` on Linux



Operating System Software

- Fundamentally, OS functions the same way as ordinary computer software
 - It is a program that is executed (just like applications)
 - It has more privileges
- Operating system relinquishes control of the processor to execute other programs
 - Reestablishes control after
 - System calls
 - Interrupts (especially timer interrupts)

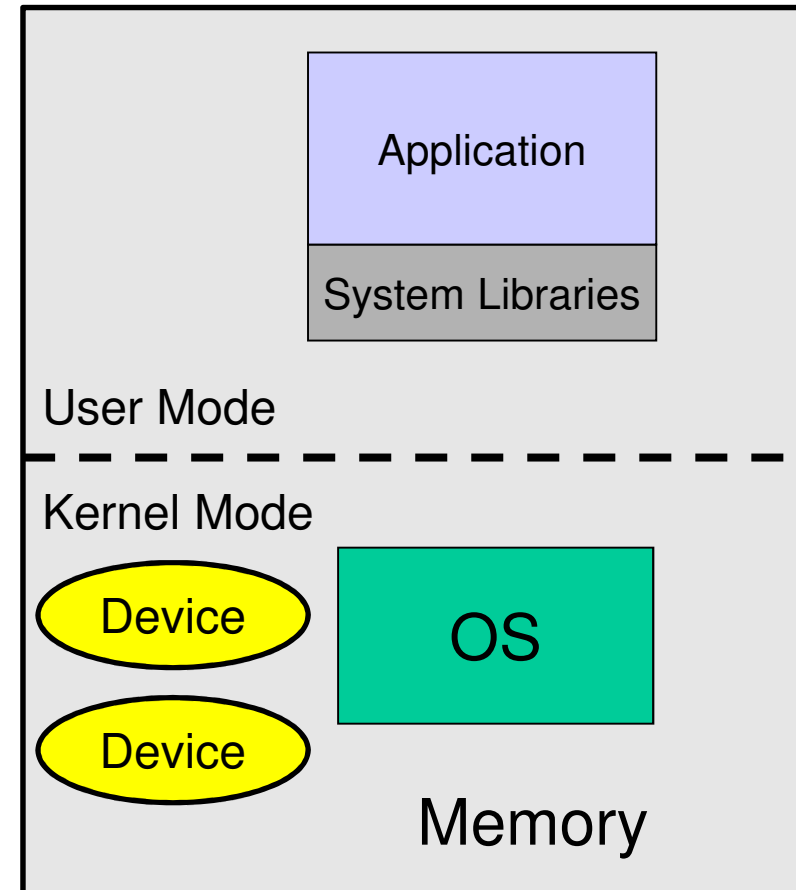

Major OS Concepts (Overview)

- Processes
- Concurrency and deadlocks
- Memory management
- Files
- Scheduling and resource management
- Information Security and Protection



Processes

- A program in execution
- An instance of a program running on a computer
- The entity that can be assigned to and executed on a processor
- A unit of resource ownership



Process

- Minimally consist of three segments
 - Text
 - contains the code (instructions)
 - Data
 - Global variables
 - Stack
 - Activation records of procedure
 - Local variables
- Note:
 - data can dynamically grow up
 - The stack can dynamically grow down

Memory

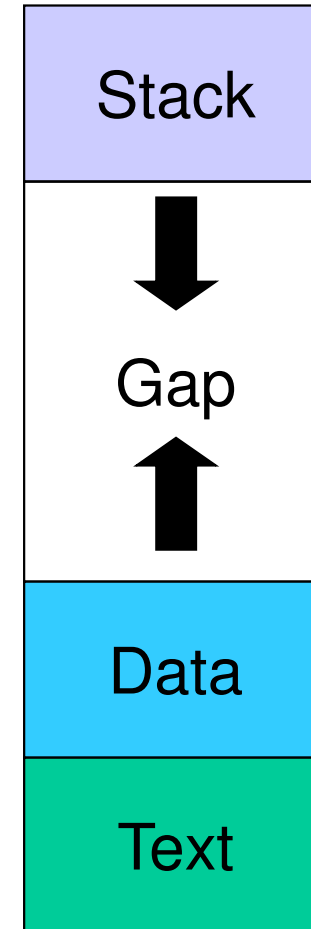

Process state

- Consists of three components
 - An executable program
 - text
 - Associated data needed by the program
 - Data and stack
 - Execution context of the program
 - Registers, program counter, stack pointer
 - Information the operating system needs to manage the process
 - OS-internal bookkeeping, files open, etc...



Multiple processes creates concurrency issues

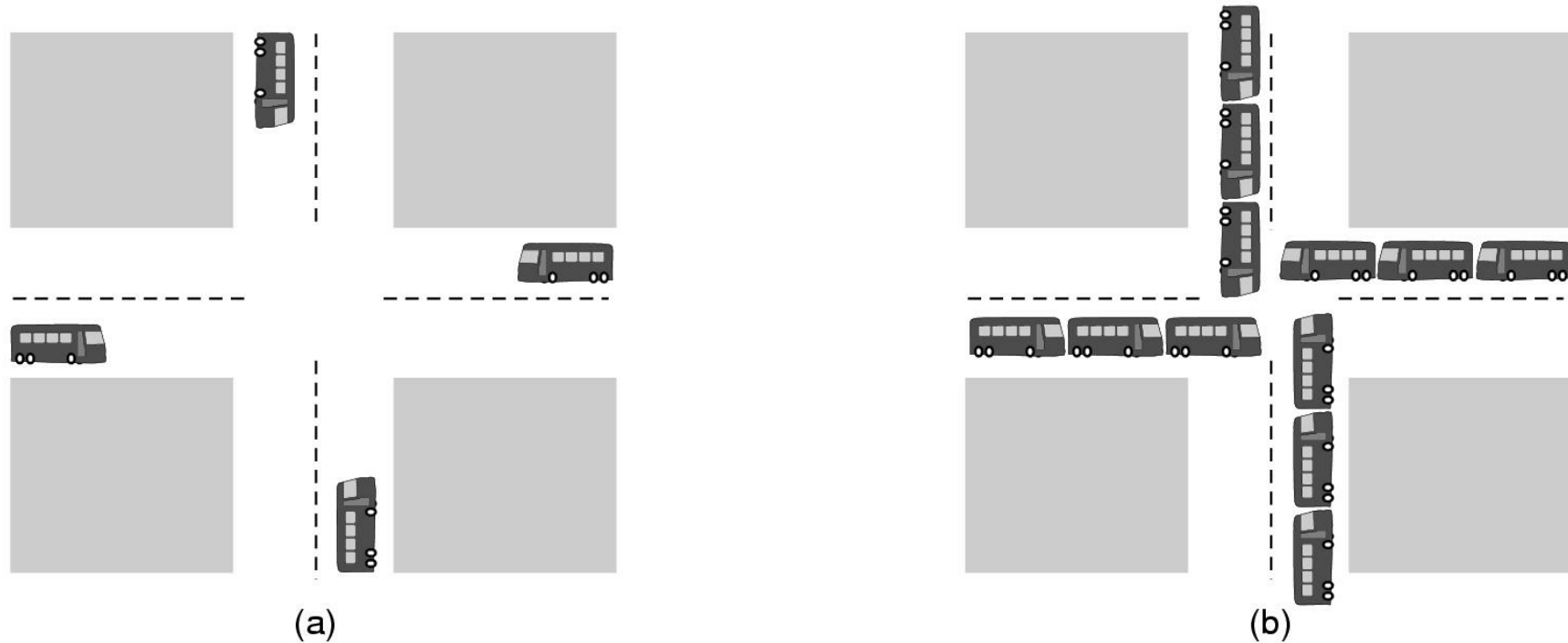

(a) A potential deadlock. (b) an actual deadlock.

Memory Management

- The view from thirty thousand feet
 - Process isolation
 - Prevent processes from accessing each others data
 - Automatic allocation and management
 - Don't want users to deal with physical memory directly
 - Protection and access control
 - Still want controlled sharing
 - Long-term storage
 - OS services
 - Virtual memory
 - File system



Virtual Memory

- Allows programmers to address memory from a logical point of view
 - Gives apps the illusion of having RAM to themselves
 - Logical addresses are independent of other processes
 - Provides isolation of processes from each other
- Can overlap execution of one process while swapping in/out others to disk.



Virtual Memory Addressing

Memory management unit (hardware) translates program memory addresses to main memory addresses.

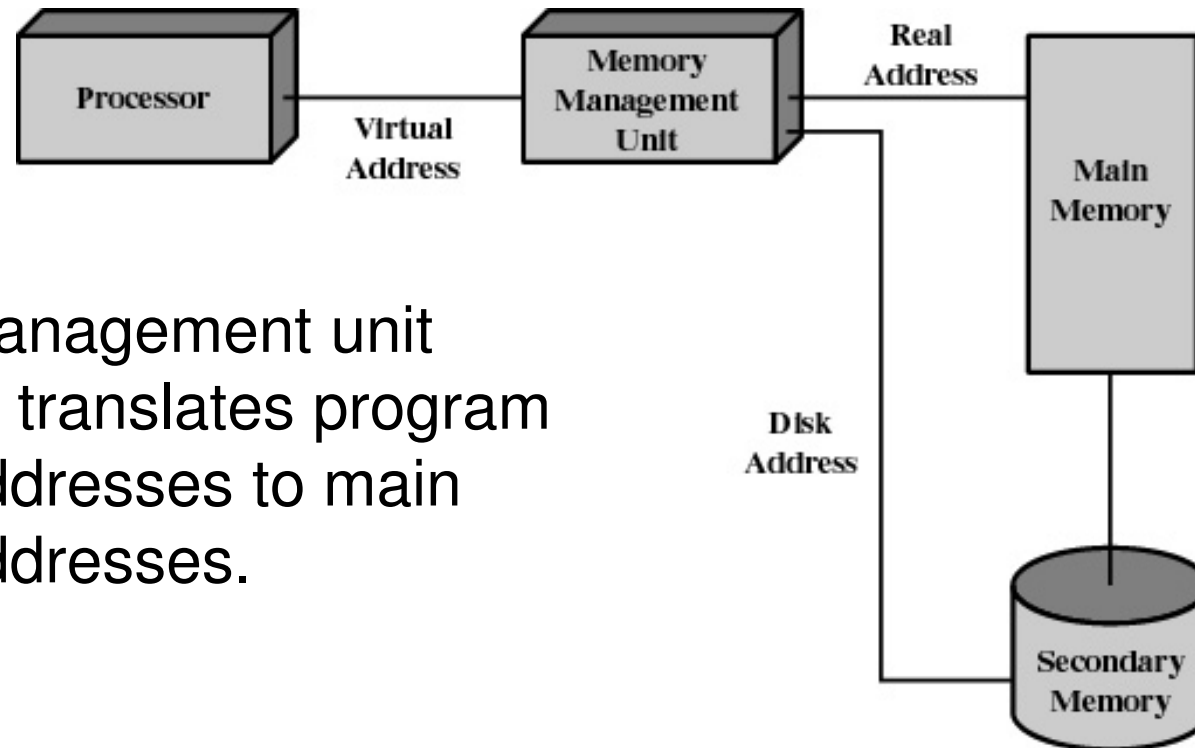

Figure 2.10 Virtual Memory Addressing



File System

- Implements long-term store
- Information stored in named objects called files



Example File System

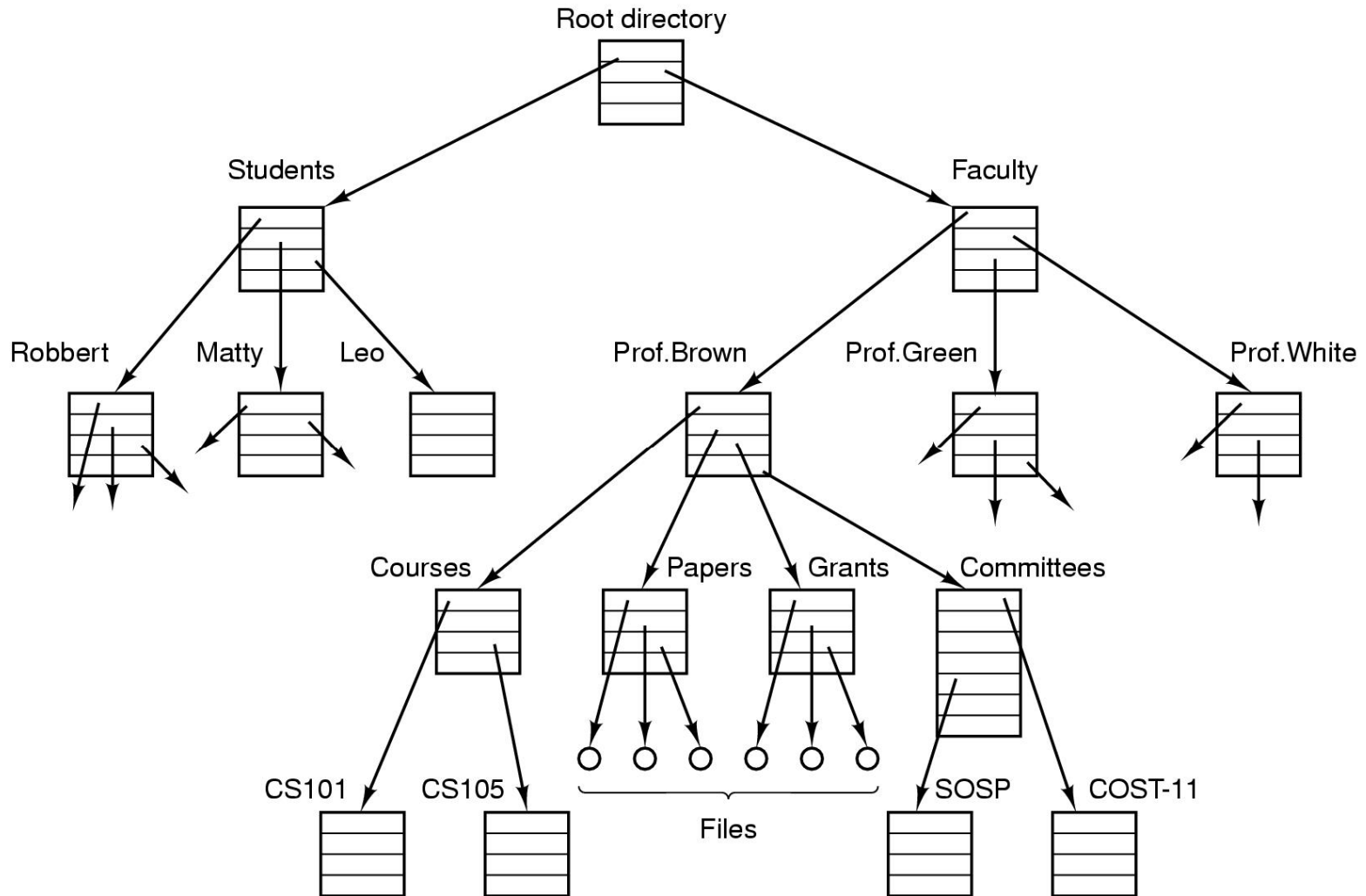

Information Protection and Security

- Access control
 - regulate user access to the system
 - Involves authentication
- Information flow control
 - regulate flow of data within the system and its delivery to users



Scheduling and Resource Management

- Fairness
 - give equal and fair access to all processes
- Differential responsiveness
 - discriminate between different classes of jobs
- Efficiency
 - maximize throughput, minimize response time, and accommodate as many uses as possible



Operating System Internal Structure?



Classic Operating System Structure

- The layered approach
 - a) Processor allocation and multiprogramming
 - b) Memory Management
 - c) Devices
 - d) File system
 - e) Users
- Each layer depends on the inner layers

Unrealistic!

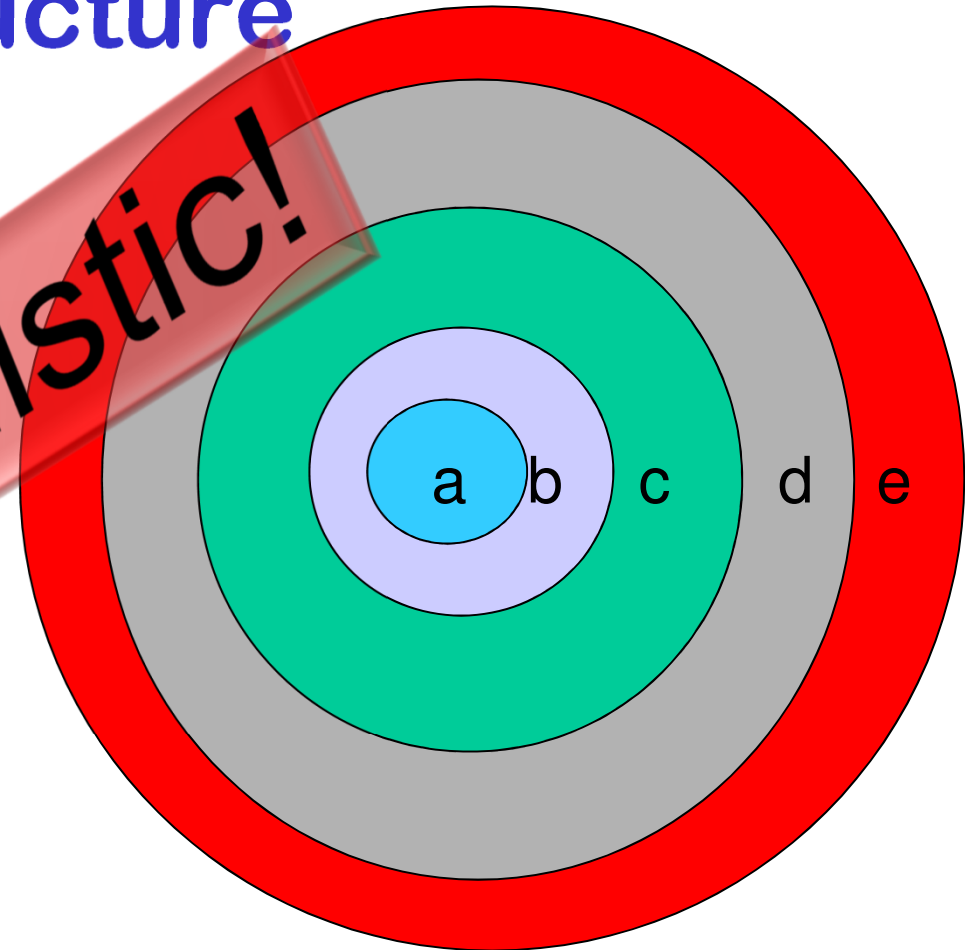

Operating System Structure

- In practice, layering is only a guide
 - Operating Systems have many interdependencies
 - Scheduling on virtual memory
 - Virtual memory (VM) on I/O to disk
 - VM on files (page to file)
 - Files on VM (memory mapped files)
 - And many more...



The Monolithic Operating System Structure

- Also called the “spaghetti nest” approach
 - Everything is tangled up with everything else.
- Linux, Windows,
.....

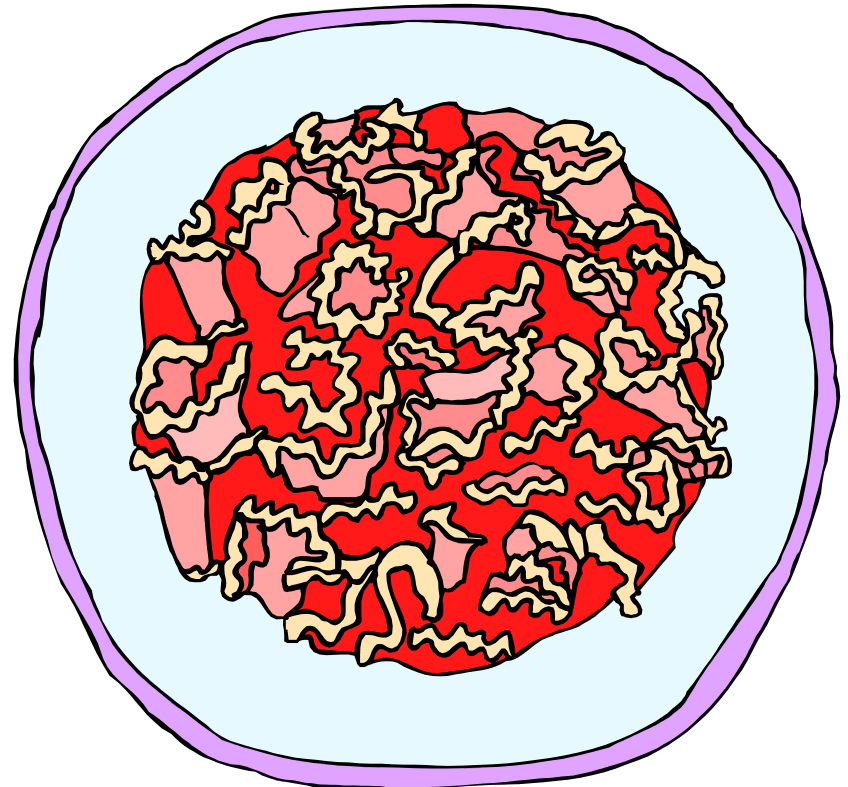

The Monolithic Operating System Structure

- However, some reasonable structure usually prevails

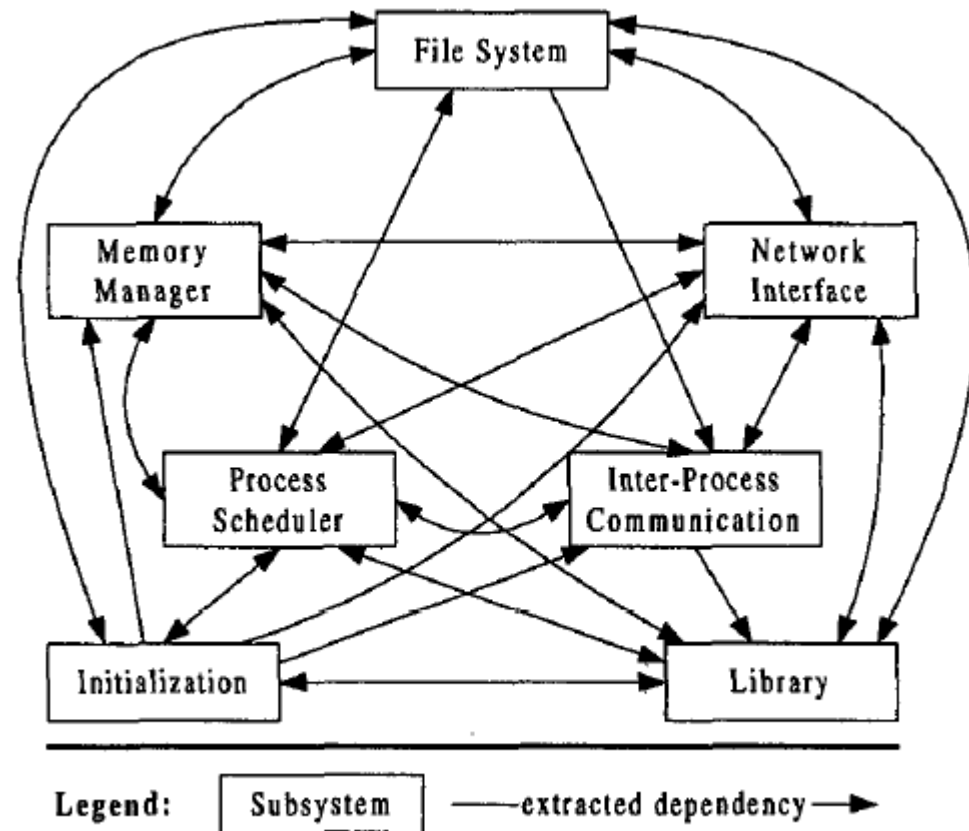

Bowman, I. T., Holt, R. C., and Brewster, N. V. 1999. Linux as a case study: its extracted software architecture. In *Proceedings of the 21st international Conference on Software Engineering* (Los Angeles, California, United States, May 16 - 22, 1999). ICSE '99. ACM, New York, NY, 555-563. DOI= <http://doi.acm.org/10.1145/302405.302691>



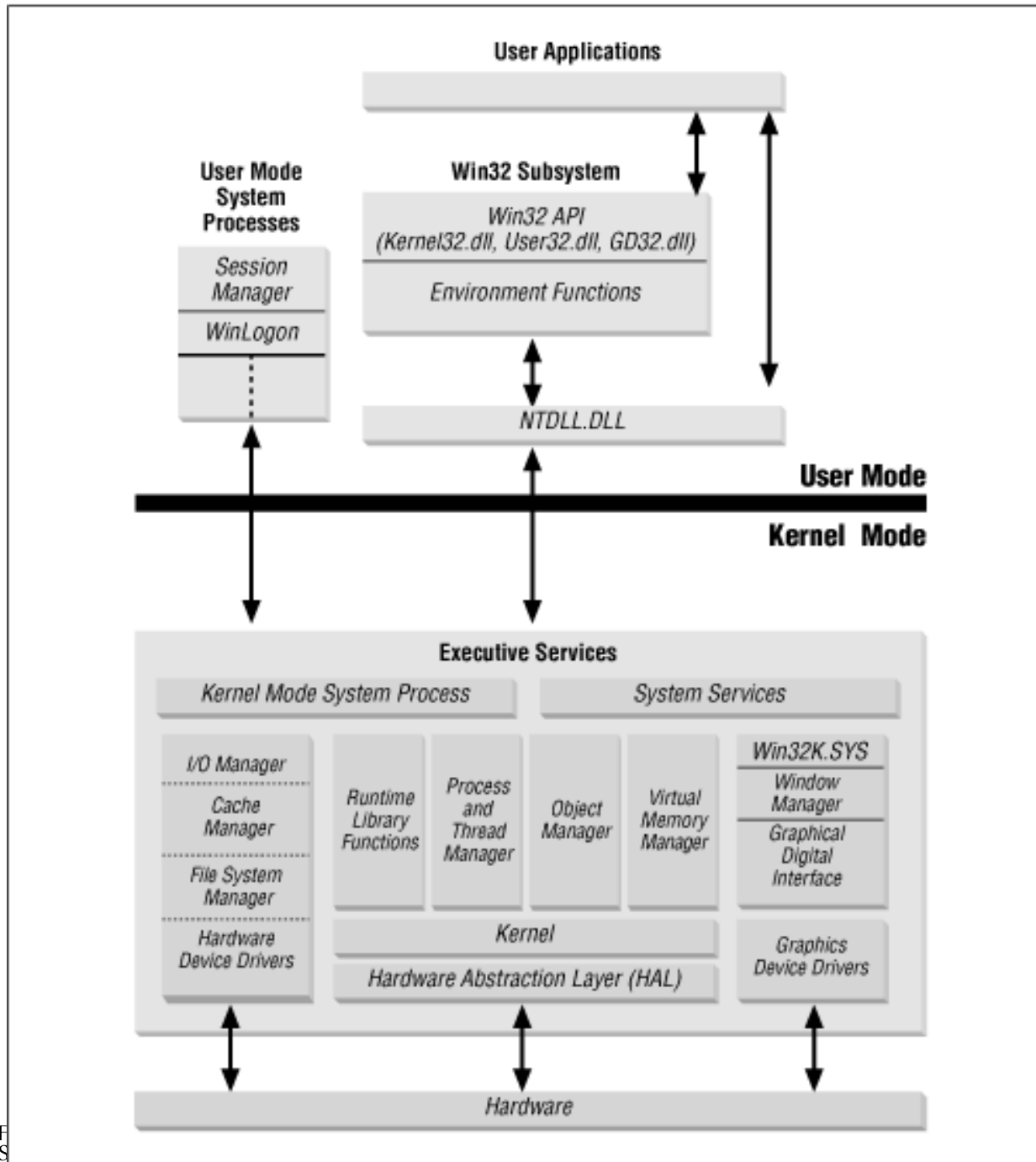

Computer Hardware Review

Chapter 1.4



Learning Outcomes

- Understand the basic components of computer hardware
 - CPU, buses, memory, devices controllers, DMA, Interrupts, hard disks
- Understand the concepts of memory hierarchy and caching, and how they affect performance.



Operating Systems

- Exploit the hardware available
- Provide a set of high-level services that represent or are implemented by the hardware.
- Manages the hardware reliably and efficiently
- *Understanding operating systems requires a basic understanding of the underlying hardware*



Basic Computer Elements

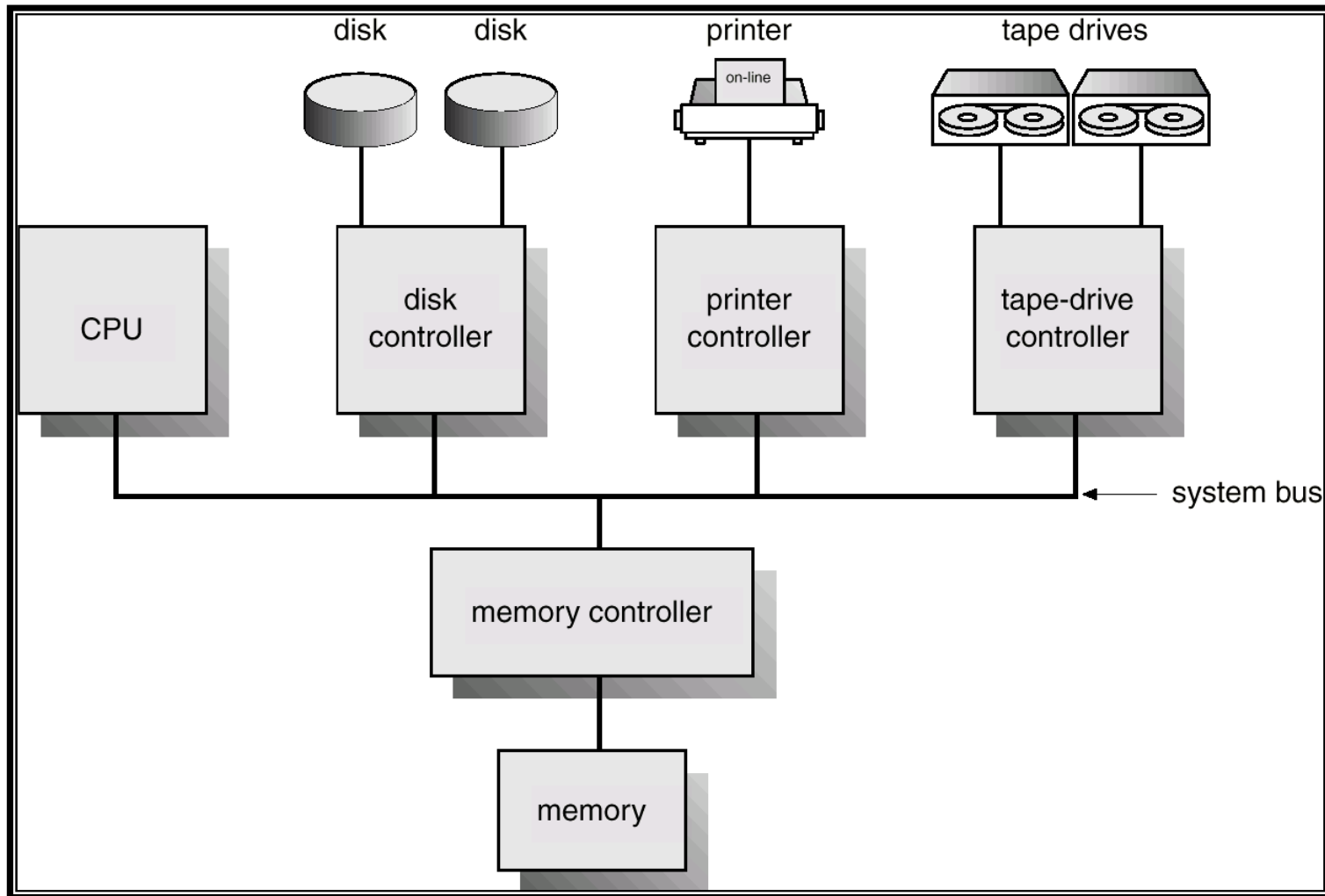

Basic Computer Elements

- CPU
 - Performs computations
 - Load data to/from memory via system bus
- Device controllers
 - Control operation of their particular device
 - Operate in parallel with CPU
 - Can also load/store to memory (Direct Memory Access, DMA)
 - Control register appear as memory locations to CPU
 - Or I/O ports
 - Signal the CPU with “interrupts”
- Memory Controller
 - Responsible for refreshing dynamic RAM
 - Arbitrating access between different devices and CPU



The real world is logically similar, but more complex

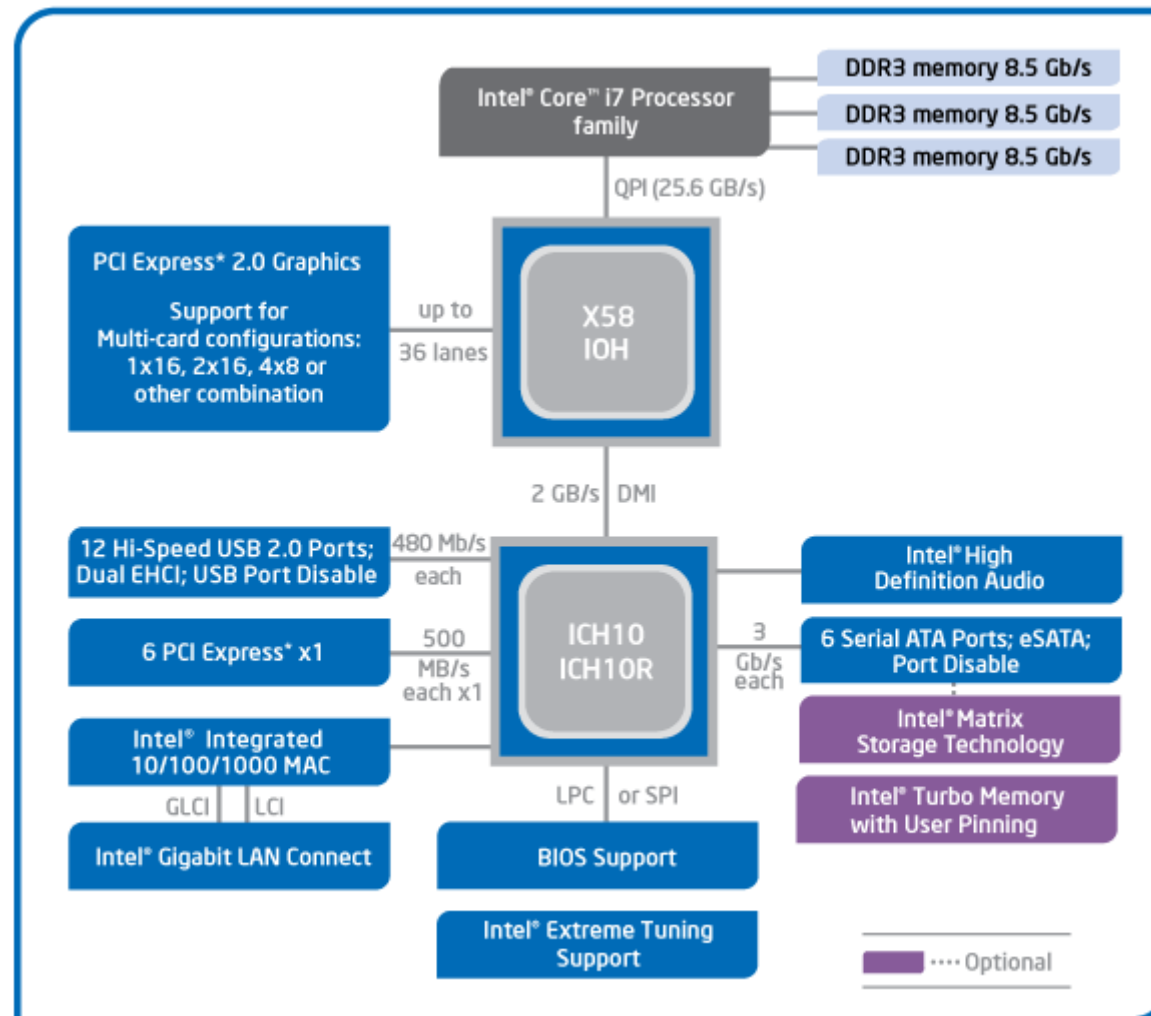

Intel® X58 Express Chipset Block Diagram



A Simple Model of CPU Computation

- The fetch-execute cycle

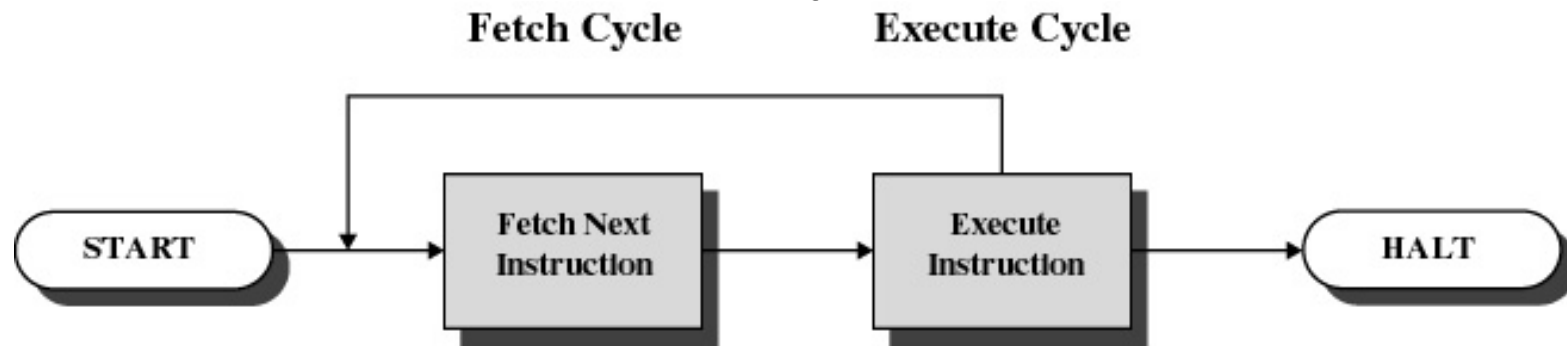

Figure 1.2 Basic Instruction Cycle

A Simple Model of CPU Computation

- The fetch-execute cycle
 - Load memory contents from address in program counter (PC)
 - The instruction
 - Execute the instruction
 - Increment PC
 - Repeat

CPU Registers

PC: 0x0300
SP: 0xcbf3
Status
R1
↑ ↓
Rn



A Simple Model of CPU Computation

- Stack Pointer
- Status Register
 - Condition codes
 - Positive result
 - Zero result
 - Negative result
- General Purpose Registers
 - Holds operands of most instructions
 - Enables programmers (compiler) to minimise memory references.

CPU Registers

PC: 0x0300
SP: 0xcbf3
Status
R1
↑
Rn



Privileged-mode Operation

CPU Registers

- To protect operating system execution, two or more CPU modes of operation exist
 - Privileged mode (system-, kernel-mode)
 - All instructions and registers are available
 - User-mode
 - Uses 'safe' subset of the instruction set
 - E.g. no disable interrupts instruction
 - Only 'safe' registers are accessible

Interrupt Mask
Exception Type
MMU regs
Others
PC: 0x0300
SP: 0xcbf3
Status
R1
↑ ↓
Rn



'Safe' registers and instructions

- Registers and instructions are safe if
 - Only affect the state of the application itself
 - They cannot be used to uncontrollably interfere with
 - The operating system
 - Other applications
 - They cannot be used to violate a correctly implemented operating system.



Example Unsafe Instruction

- “cli” instruction on x86 architecture
 - Disables interrupts

- Example exploit

```
cli /* disable interrupts */  
while (true)  
    /* loop forever */;
```



Privileged-mode Operation

Memory Address Space

- The accessibility of addresses within an address space changes depending on operating mode
 - To protect kernel code and data
- Note: The exact memory ranges are usually configurable, and vary between CPU architectures and/or operating systems.

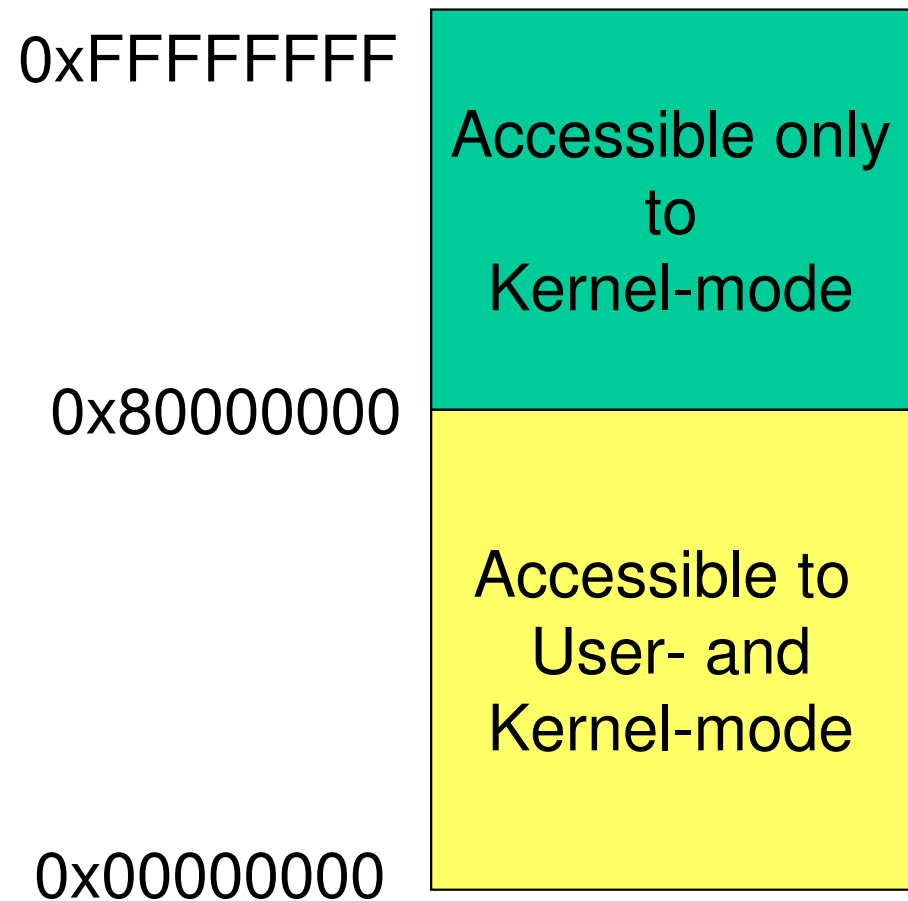

I/O and Interrupts

- I/O events (keyboard, mouse, incoming network packets) happen at unpredictable times
- How does the CPU know when to service an I/O event?



Interrupts

- An interruption of the normal sequence of execution
- A suspension of processing caused by an event external to that processing, and performed in such a way that the processing can be resumed.
- Improves processing efficiency
 - Allows the processor to execute other instructions while an I/O operation is in progress
 - Avoids unnecessary completion checking (polling)



Interrupt Cycle

- Processor checks for interrupts
- If no interrupts, fetch the next instruction
- If an interrupt is pending, divert to the interrupt handler

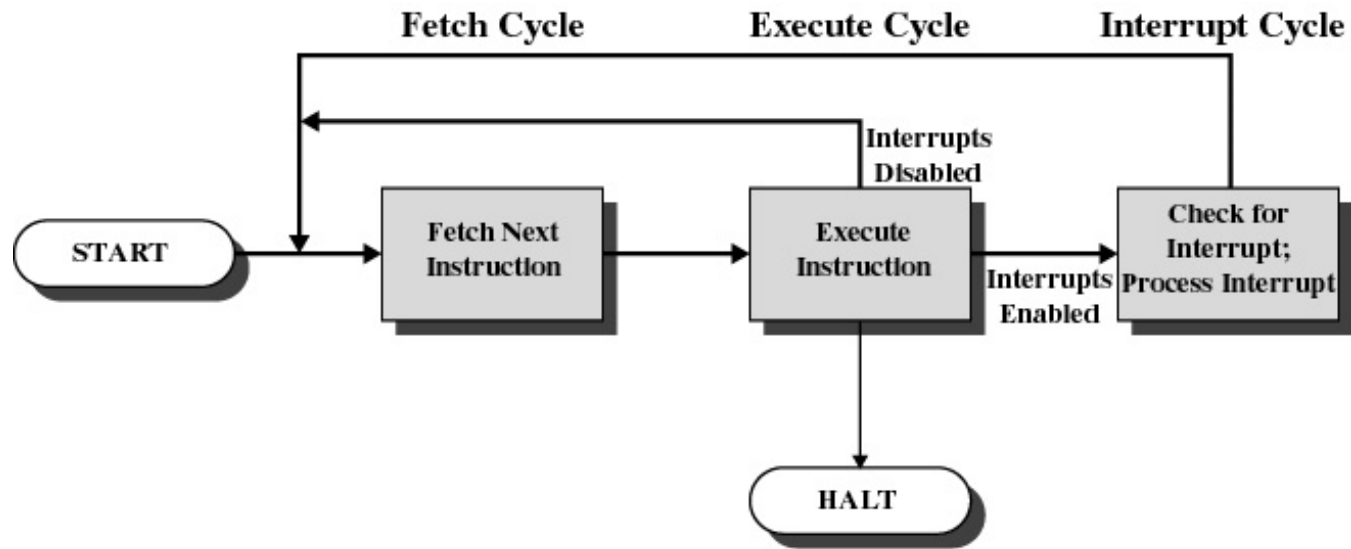

Interrupt Terminology

- Program *exceptions*
(sometimes called *synchronous interrupts, traps*)
 - Arithmetic overflow
 - Division by zero
 - Executing an illegal/privileged instruction
 - Reference outside user's memory space.
- Asynchronous (external) interrupts
(usually just called *interrupts*)
 - Timer
 - I/O
 - Hardware or power failure



Interrupt Handler

- A software routine that determines the nature of the interrupt and performs whatever actions are needed.
- Control is transferred to the handler by *hardware*.
- The handler is generally part of the operating system.



Simple Interrupt

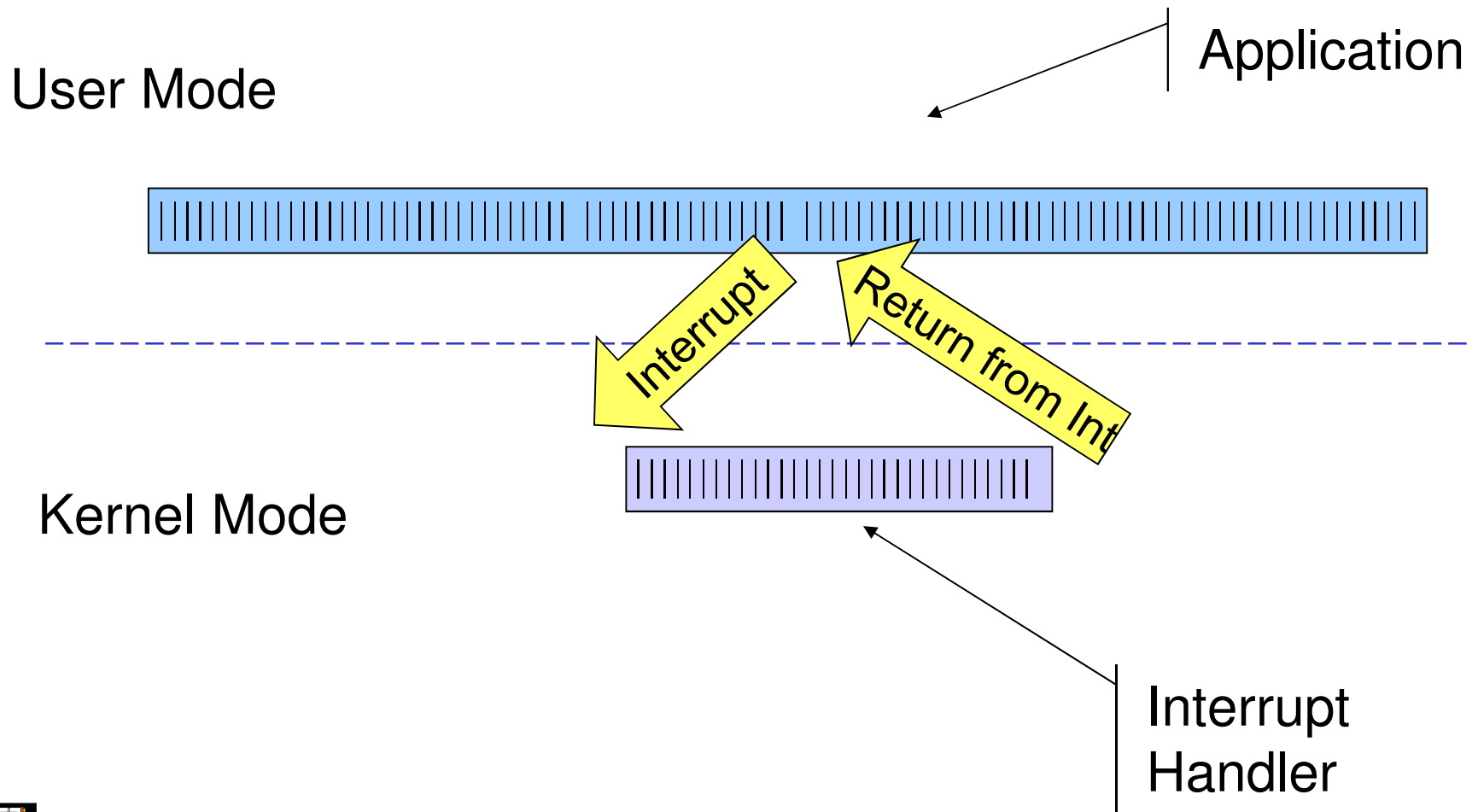

Memory Hierarchy

- Going down the hierarchy
 - Decreasing cost per bit
 - Increasing capacity
 - Increasing access time
- Decreasing frequency of access to the memory by the processor
 - Hopefully
 - **Principle of locality!!!!!!**

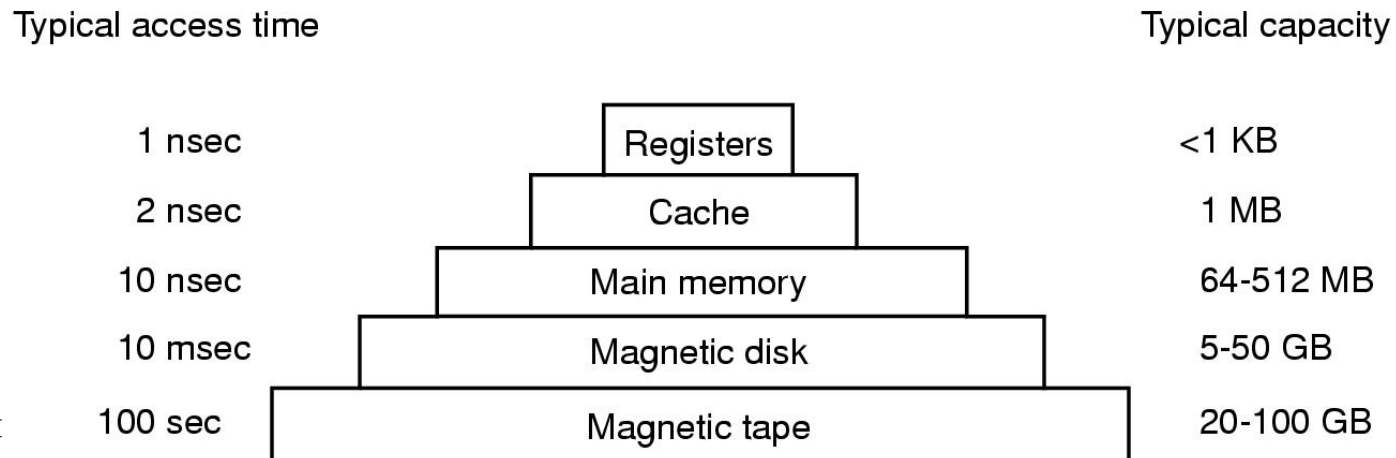

Caching as a general technique

- Given a two-levels data storage: small and fast, versus large and slow,
- Can speed access to slower data by using intermediate-speed memory as a cache.



A hardware approach to improving system performance?

CPU Registers
Fast

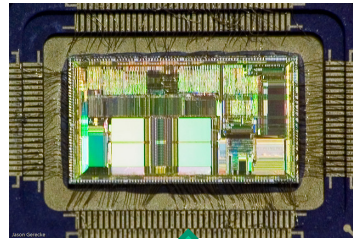

Cache Memory (SRAM)
Fast

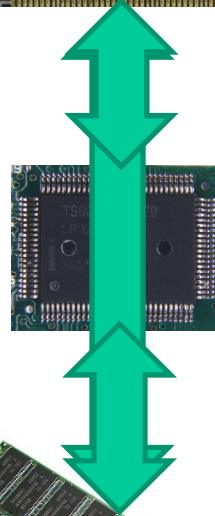

Main Memory (DRAM)
Slow

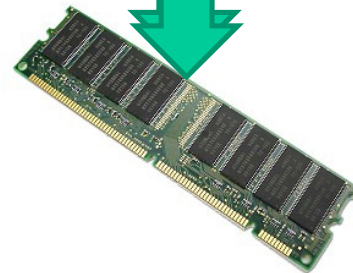

CPU Cache

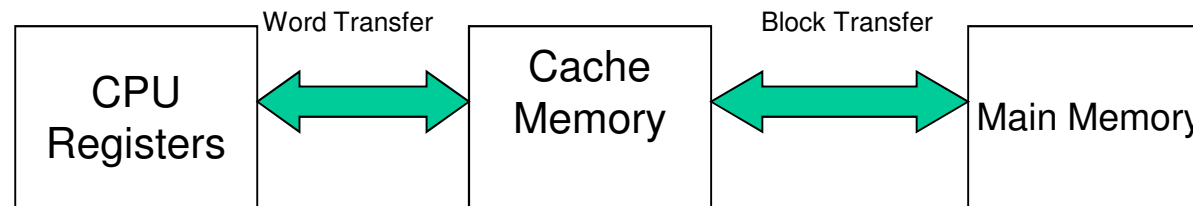

- CPU cache is fast memory placed between the CPU and main memory
 - 1 to a few cycles access time compared to RAM access time of tens – hundreds of cycles
- Holds recently used data or instructions to save memory accesses.
- Matches slow RAM access time to CPU speed if high hit rate
- Is hardware maintained and (mostly) transparent to software
- Sizes range from few kB to several MB.
- Usually a hierarchy of caches (2–5 levels), on- and off-chip.
- Block transfers can achieve higher transfer bandwidth than single words.
 - Also assumes probability of using newly fetch data is higher than the probability of reusing ejected data.



Performance

- What is the effective access time of memory subsystem?
- Answer: It depends on the hit rate in the first level.

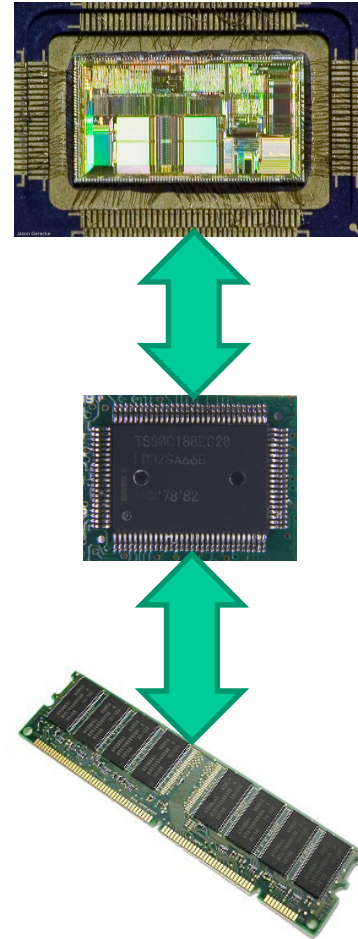

Effective Access Time

$$T_{eff} = H \times T_1 + (1 - H) \times T_2$$

T_1 = access time of memory 1

T_2 = access time of memory 2

H = hit rate in memory 1

T_{eff} = effective access time of system



Example

- Cache memory access time 1ns
- Main memory access time 10ns
- Hit rate of 95%

$$\begin{aligned}T_{eff} &= 0.95 \times 10^{-9} + \\ &(1 - 0.95) \times (10^{-9} + 10 \times 10^{-9}) \\ &= 1.5 \times 10^{-9}\end{aligned}$$



Moving-Head Disk Mechanism

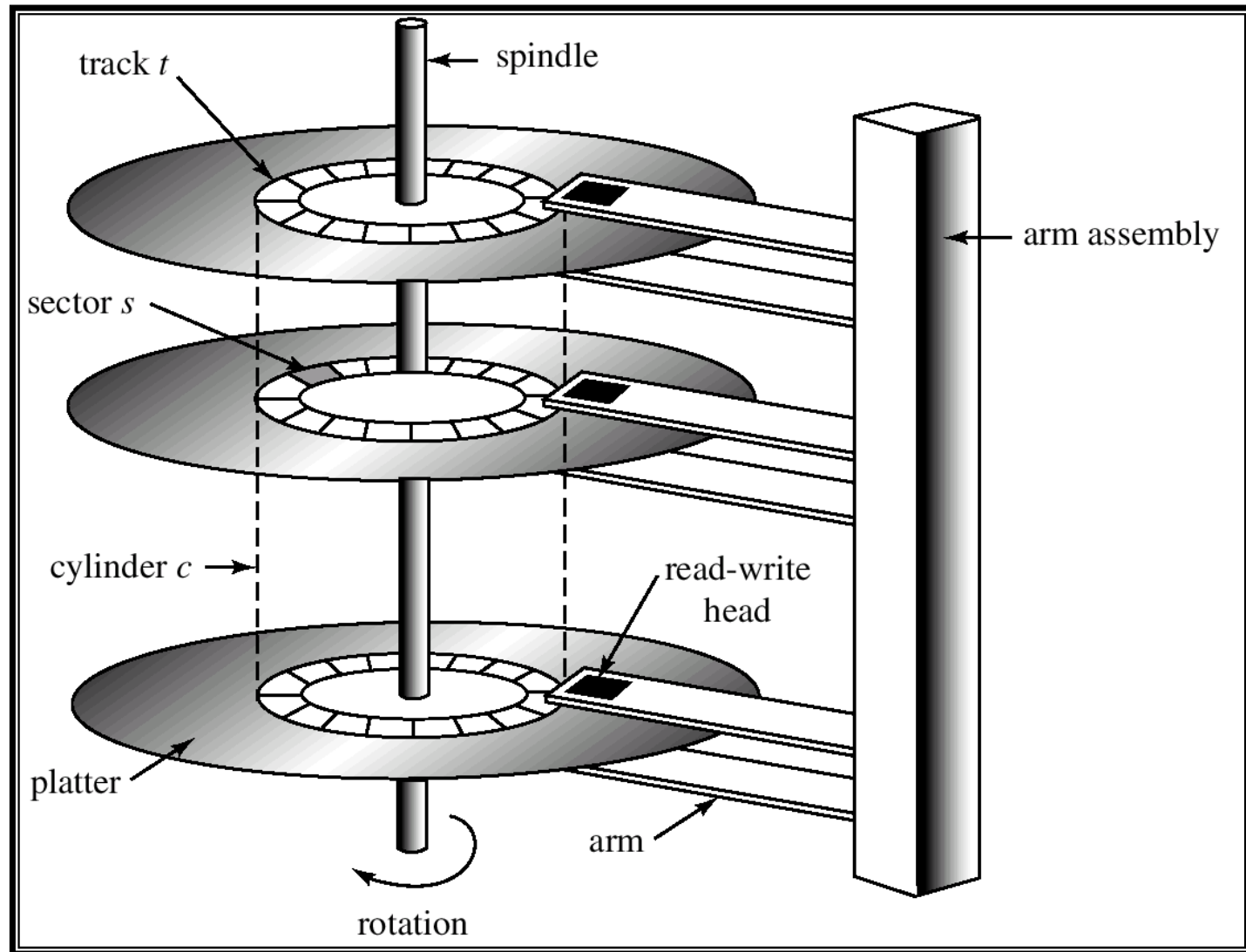

Example Disk Access Times

- Disk can read/write data relatively fast
 - 15,000 rpm drive - 80 MB/sec
 - 1 KB block is read in 12 microseconds
- Access time dominated by time to locate the head over data
 - Rotational latency
 - Half one rotation is 2 milliseconds
 - Seek time
 - Full inside to outside is 8 milliseconds
 - Track to track .5 milliseconds
- 2 milliseconds is 164KB in “lost bandwidth”



A OS approach to improving system performance?

CPU Registers
Fast

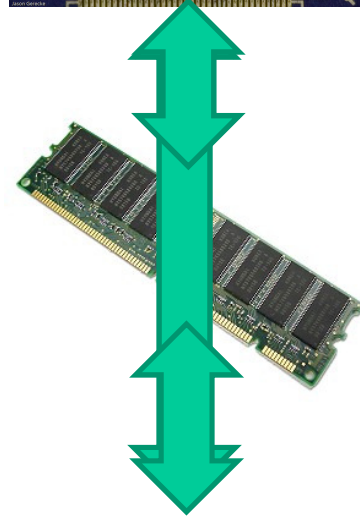
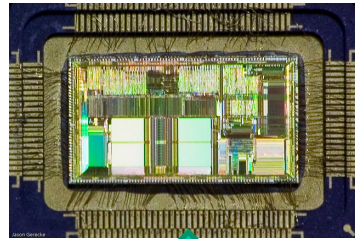

Main Memory (DRAM)
Fast



Hard disk
Slow...



A Strategy: Avoid Waiting for Disk Access

- Keep a subset of the disk's data in main memory
- ⇒ OS uses main memory as a *cache* of disk contents



Application approach to improving system performance

Web browser
Fast



Hard disk
Fast



Internet
Slow...



A Strategy: Avoid Waiting for Internet Access

- Keep a subset of the Internet's data on disk
- ⇒ Application uses disk as a *cache* of the Internet

