

## Processes and Threads Implementation

## Learning Outcomes

- An understanding of the typical implementation strategies of processes and threads
  - Including an appreciation of the trade-offs between the implementation approaches
    - Kernel-threads versus user-level threads
- A detailed understanding of “context switching”

## Summary: The Process Model

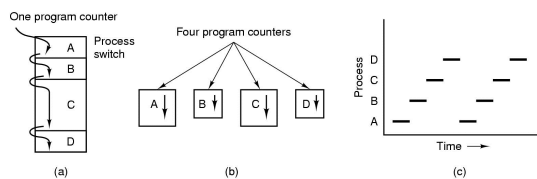

- Multiprogramming of four programs
- Conceptual model of 4 independent, sequential processes (with a single thread each)
- Only one program active at any instant



## Processes

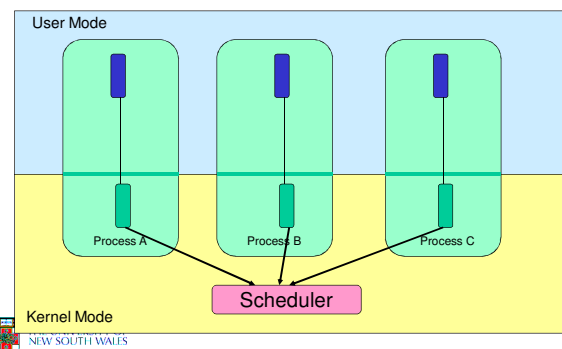

## Processes

- User-mode
  - Processes (programs) scheduled by the kernel
  - Isolated from each other
  - No concurrency issues between each other
- System-calls transition into and return from the kernel
- Kernel-mode
  - Nearly all activities still associated with a process
  - Kernel memory shared between all processes
  - Concurrency issues exist between processes concurrently executing in a system call

## Threads The Thread Model

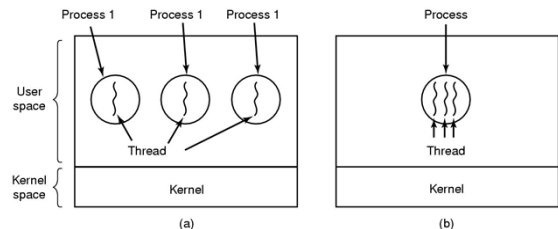

- (a) Three processes each with one thread
- (b) One process with three threads

## The Thread Model

### Per process items

Address space  
Global variables  
Open files  
Child processes  
Pending alarms  
Signals and signal handlers  
Accounting information

### Per thread items

Program counter  
Registers  
Stack  
State

- Items shared by all threads in a process
- Items private to each thread

## The Thread Model

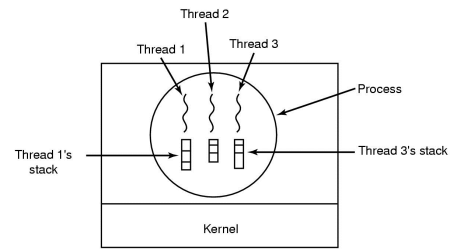

Each thread has its own stack

## Where to Implement Application Threads?

Note: Thread API similar in both cases

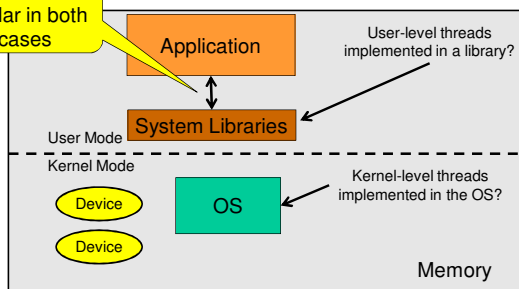

## Implementing Threads in User Space

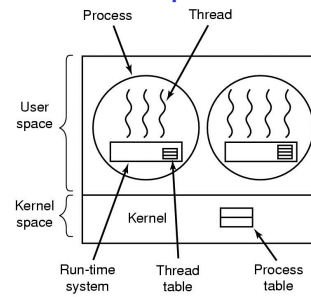

A user-level threads package

## User-level Threads

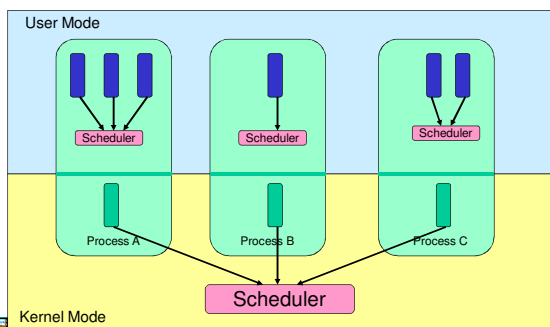

## User-level Threads

- Implementation at user-level
  - User-level Thread Control Block (TCB), ready queue, blocked queue, and dispatcher
  - Kernel has no knowledge of the threads (it only sees a single process)
  - If a thread blocks waiting for a resource held by another thread, its state is saved and the dispatcher switches to another ready thread
  - Thread management (create, exit, yield, wait) are implemented in a runtime support library

## User-Level Threads

- Pros
  - Thread management and switching at user level is much faster than doing it in kernel level
    - No need to trap (take syscall exception) into kernel and back to switch
  - Dispatcher algorithm can be tuned to the application
    - E.g. use priorities
  - Can be implemented on any OS (thread or non-thread aware)
  - Can easily support massive numbers of threads on a per-application basis
    - Use normal application virtual memory
    - Kernel memory more constrained. Difficult to efficiently support widely differing numbers of threads for different applications.

## User-level Threads

- Cons
  - Threads have to yield() manually (no timer interrupt delivery to user-level)
    - Co-operative multithreading
      - A single poorly design/implemented thread can monopolise the available CPU time
    - There are work-arounds (e.g. a timer signal per second to enable pre-emptive multithreading), they are course grain and a kludge.
  - Does not take advantage of multiple CPUs (in reality, we still have a single threaded process as far as the kernel is concerned)

## User-Level Threads

- Cons
  - If a thread makes a blocking system call (or takes a page fault), the process (and all the internal threads) blocks
    - Can't overlap I/O with computation
  - Can use wrappers as a work around
    - Example: wrap the read() call
      - Use select() to test if read system call would block
        - » select() then read()
        - » Only call read() if it won't block
        - » Otherwise schedule another thread
    - Wrapper requires 2 system calls instead of one
      - » Wrappers are needed for environments doing lots of blocking system calls – exactly when efficiency matters!



## Implementing Threads in the Kernel

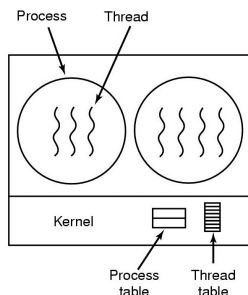

A threads package managed by the kernel

## Kernel-Level Threads

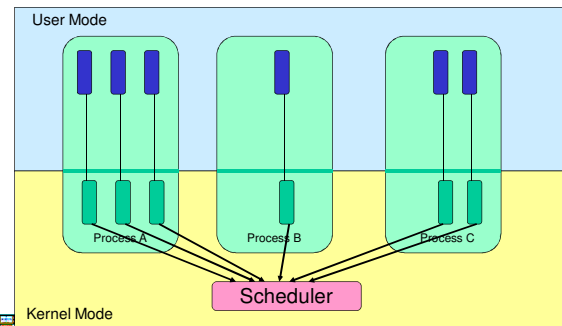

## Kernel Threads

- Threads are implemented in the kernel
  - TCBs are stored in the kernel
    - A subset of information in a traditional PCB
      - The subset related to execution context
    - TCBs have a PCB associated with them
      - Resources associated with the group of threads (the process)
  - Thread management calls are implemented as system calls
    - E.g. create, wait, exit

## Kernel Threads

- Cons
  - Thread creation and destruction, and blocking and unblocking threads requires kernel entry and exit.
    - More expensive than user-level equivalent
- Pros
  - **Preemptive** multithreading
  - Parallelism
    - Can overlap blocking I/O with computation
    - Can take advantage of a multiprocessor

## Multiprogramming Implementation

1. Hardware stacks program counter, etc.
2. Hardware loads new program counter from interrupt vector.
3. Assembly language procedure saves registers.
4. Assembly language procedure sets up new stack.
5. C interrupt service runs (typically reads and buffers input).
6. Scheduler decides which process is to run next.
7. C procedure returns to the assembly code.
8. Assembly language procedure starts up new current process.

Skeleton of what lowest level of OS does when an interrupt occurs – a context switch

## Context Switch Terminology

- A context switch can refer to
  - A switch between threads
    - Involving saving and restoring of state associated with a thread
  - A switch between processes
    - Involving the above, plus extra state associated with a process.
      - E.g. memory maps

## Context Switch Occurrence

- A switch between process/threads can happen any time the OS is invoked
  - On a system call
    - Mandatory if system call blocks or on exit();
  - On an exception
    - Mandatory if offender is killed
  - On an interrupt
    - Triggering a dispatch is the main purpose of the *timer interrupt*

**A thread switch can happen between any two instructions**

Note instructions do not equal program statements

## Context Switch

- Context switch must be *transparent* for processes/threads
    - When dispatched again, process/thread should not notice that something else was running in the meantime (except for elapsed time)
- ⇒ OS must save all state that affects the thread
- This state is called the *process/thread context*
  - Switching between process/threads consequently results in a *context switch*.

## Simplified Explicit Thread Switch

25

## Assume Kernel-Level Threads

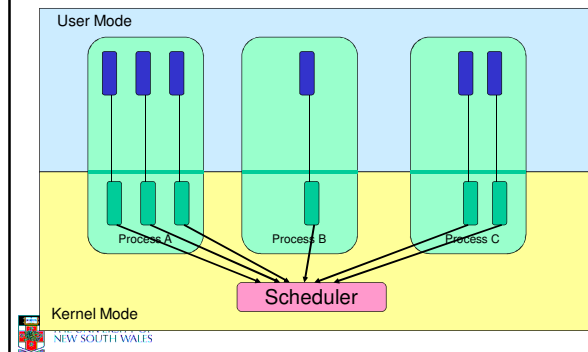

## Example Context Switch

- Running in user mode, SP points to user-level stack (not shown on slide)

Representation of Kernel Stack (Memory)



THE UNIVERSITY OF NEW SOUTH WALES

27

## Example Context Switch

- Take an exception, syscall, or interrupt, and we switch to the kernel stack



THE UNIVERSITY OF NEW SOUTH WALES

28

## Example Context Switch

- We push a *trapframe* on the stack
  - Also called *exception frame*, *user-level context*....
  - Includes the user-level PC and SP



THE UNIVERSITY OF NEW SOUTH WALES

29

## Example Context Switch

- Call 'C' code to process syscall, exception, or interrupt
  - Results in a 'C' activation stack building up

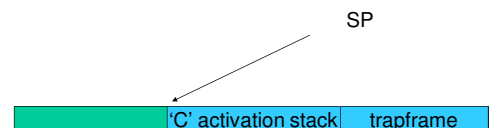

THE UNIVERSITY OF NEW SOUTH WALES

30

## Example Context Switch

- The kernel decides to perform a context switch
  - It chooses a target thread (or process)
  - It pushes remaining kernel context onto the stack

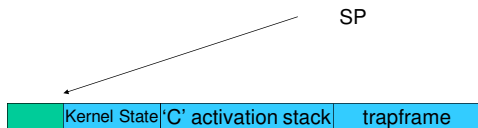

## Example Context Switch

- Any other existing thread must
  - be in kernel mode (on a uni processor),
  - and have a similar stack layout to the stack we are currently using

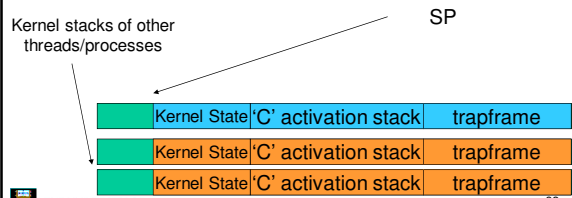

## Example Context Switch

- We save the current SP in the PCB (or TCB), and load the SP of the target thread.
  - Thus we have *switched contexts*

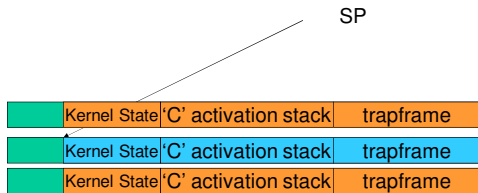

## Example Context Switch

- Load the target thread's previous context, and return to C

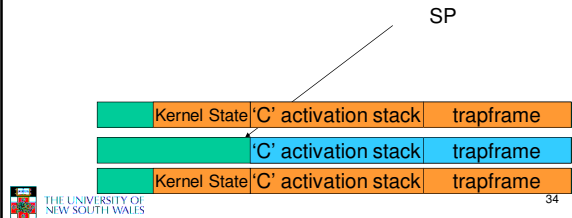

## Example Context Switch

- The C continues and (in this example) returns to user mode.

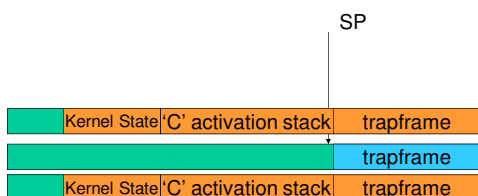

## Example Context Switch

- The user-level context is restored

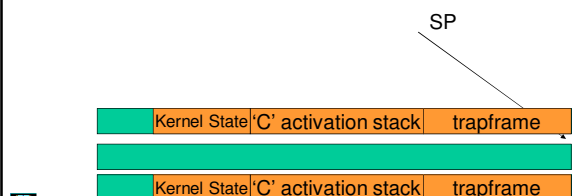

## Example Context Switch

- The user-level SP is restored

SP

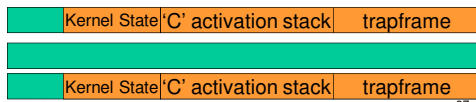

## The Interesting Part of a Thread Switch

- What does the “push kernel state” part do???

SP

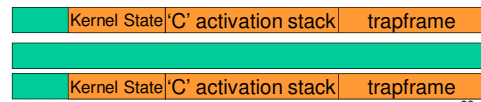

## Simplified OS/161 thread\_switch

```
static
void
thread_switch(threadstate_t newstate, struct wchan *wc)
{
    struct thread *cur, *next;

    cur = curthread;
    do {
        next = threadlist_rethead(&curcpu->c_runqueue);
        if (next == NULL) {
            cpu_idle();
        }
    } while (next == NULL);

    /* do the switch (in assembler in switch.S) */
    switchframe_switch(&cur->t_context, &next->t_context);
}

```

Lots of code removed – only basics of pick next thread and run it remain

## OS/161 switchframe\_switch

```
switchframe_switch:
    /*
     * a0 contains the address of the switchframe pointer in the old thread.
     * a1 contains the address of the switchframe pointer in the new thread.
     *
     * The switchframe pointer is really the stack pointer. The other
     * registers get saved on the stack, namely:
     *
     *   s0-s6, s8
     *   gp, ra
     *
     * The order must match <mips/switchframe.h>.
     *
     * Note that while we'd ordinarily need to save s7 too, because we
     * use it to hold curthread saving it would interfere with the way
     * curthread is managed by thread.c. So we'll just let thread.c
     * manage it.
     */

```

## OS/161 switchframe\_switch

```
/* Allocate stack space for saving 10 registers. 10*4 = 40 */
addi sp, sp, -40

/* Save the registers */
sw ra, 36(sp)
sw gp, 32(sp)
sw s8, 28(sp)
sw s6, 24(sp)
sw s5, 20(sp)
sw s4, 16(sp)
sw s3, 12(sp)
sw s2, 8(sp)
sw s1, 4(sp)
sw s0, 0(sp)

/* Store the old stack pointer in the old thread */
sw sp, 0(a0)

```

Save the registers that the 'C' procedure calling convention expects preserved

## OS/161 switchframe\_switch

```
/* Get the new stack pointer from the new thread */
lw sp, 0(a1)
nop /* delay slot for load */

/* Now, restore the registers */
lw s0, 0(sp)
lw s1, 4(sp)
lw s2, 8(sp)
lw s3, 12(sp)
lw s4, 16(sp)
lw s5, 20(sp)
lw s6, 24(sp)
lw s8, 28(sp)
lw gp, 32(sp)
lw ra, 36(sp)
nop /* delay slot for load */

```

## OS/161 switchframe\_switch

```
/* and return. */  
j ra  
addi sp, sp, 40 /* in delay slot */
```

