

I/O Management

Chapter 5



Operating System Design Issues

- Efficiency
 - Most I/O devices slow compared to main memory (and the CPU)
 - Use of multiprogramming allows for some processes to be waiting on I/O while another process executes
 - Often I/O still cannot keep up with processor speed
 - Swapping may used to bring in additional Ready processes
 - More I/O operations
- **Optimise I/O efficiency – especially Disk & Network I/O**



Operating System Design Issues

- The quest for generality/uniformity:
 - Ideally, handle all I/O devices in the same way
 - Both in the OS and in user applications
 - Problem:
 - Diversity of I/O devices
 - Especially, different access methods (random access versus stream based) as well as vastly different data rates.
 - Generality often compromises efficiency!
 - Hide most of the details of device I/O in lower-level routines so that processes and upper levels see devices in general terms such as read, write, open, close.



I/O Software Layers

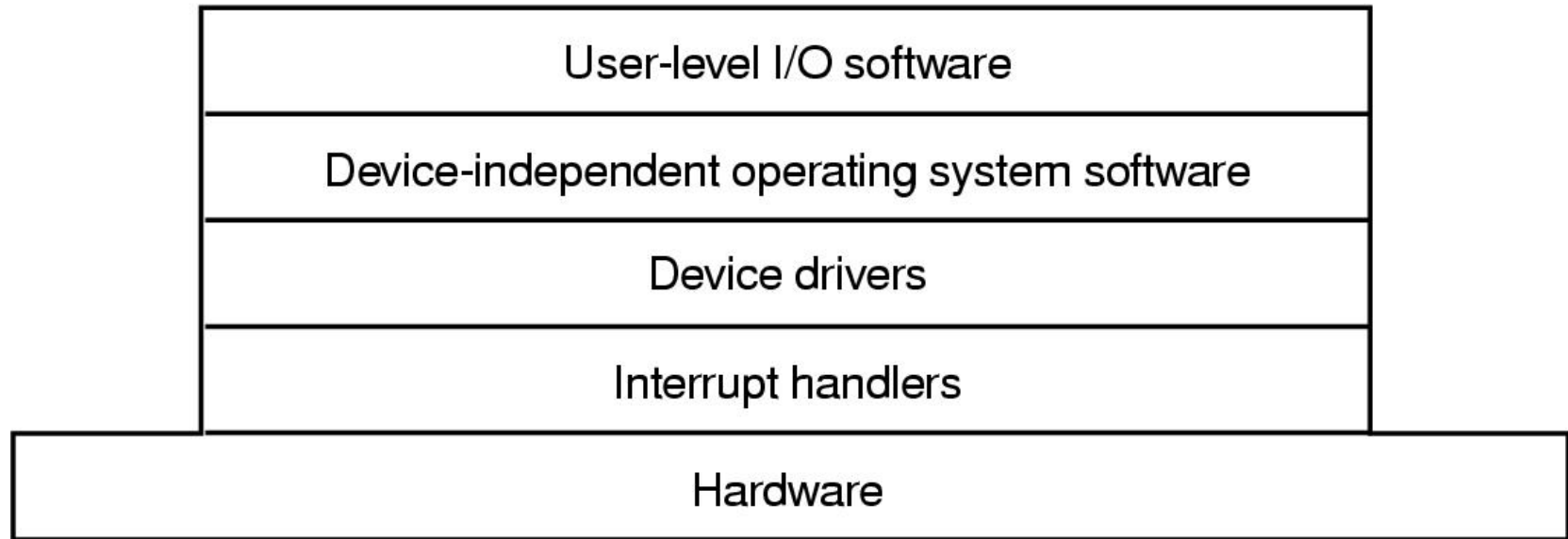

Layers of the I/O Software System



Interrupt Handlers

- Interrupt handlers are best “hidden”
 - Can execute at almost any time
 - Raise (complex) concurrency issues in the kernel
 - Have similar problems within applications if interrupts are propagated to user-level code (via signals, upcalls).
 - Generally, systems are structure such that drivers starting an I/O operations block until interrupts notify them of completion
 - Example `dev_read()` waits on semaphore that the interrupt handler signals.
- Interrupt procedure does its task
 - then unblocks driver waiting on completion



Interrupt Handler Steps

- Steps must be performed in software upon occurrence of an interrupt
 - Save regs not already saved by hardware interrupt mechanism
 - Set up context (address space) for interrupt service procedure
 - Typically, handler runs in the context of the currently running process
 - No expensive context switch
 - Set up stack for interrupt service procedure
 - Handler usually runs on the kernel stack of current process
 - Implies handler cannot block as the unlucky current process will also be blocked \Rightarrow might cause deadlock
 - Ack/Mask interrupt controller, reenables other interrupts



Interrupt Handler Steps

- Run interrupt service procedure
 - Acknowledges interrupt at device level
 - Figures out what caused the interrupt
 - Received a network packet, disk read finished, UART transmit queue empty
 - If needed, it signals blocked device driver
- In some cases, will have woken up a higher priority blocked thread
 - Choose newly woken thread to schedule next.
 - Set up MMU context for process to run next
- Load new/original process' registers
- Re-enable interrupt; Start running the new process



Device Drivers

- Logical position of device drivers is shown here
- Drivers (originally) compiled into the kernel
 - Including OS/161
 - Device installers were technicians
 - Number and types of devices rarely changed
- Nowadays they are dynamically loaded when needed
 - Linux modules
 - Typical users (device installers) can't build kernels
 - Number and types vary greatly
 - Even while OS is running (e.g hot-plug USB devices)

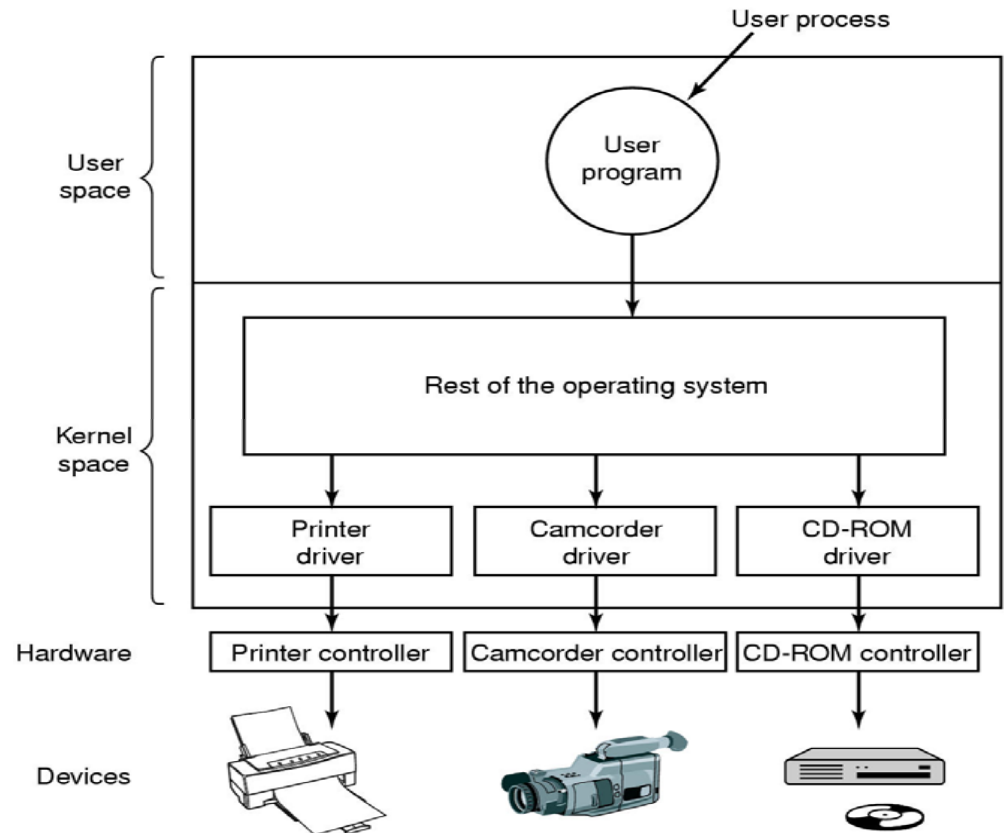

Device Drivers

- Drivers classified into similar categories
 - Block devices and character (stream of data) device
- OS defines a standard (internal) interface to the different classes of devices
- Device drivers job
 - translate request through the device-independent standard interface (open, close, read, write) into appropriate sequence of commands (register manipulations) for the particular hardware
 - Initialise the hardware at boot time, and shut it down cleanly at shutdown



Device Driver

- After issuing the command to the device, the device either
 - Completes immediately and the driver simply returns to the caller
 - Or, device must process the request and the driver usually blocks waiting for an I/O complete interrupt.
- Drivers are reentrant as they can be called by another process while a process is already blocked in the driver.
 - Reentrant: Code that can be executed by more than one thread (or CPU) at the same time
 - Manages concurrency using synch primitives



Device-Independent I/O Software

- There is commonality between drivers of similar classes
- Divide I/O software into device-dependent and device-independent I/O software
- Device independent software includes
 - Buffer or Buffer-cache management
 - Managing access to dedicated devices
 - Error reporting



Device-Independent I/O Software

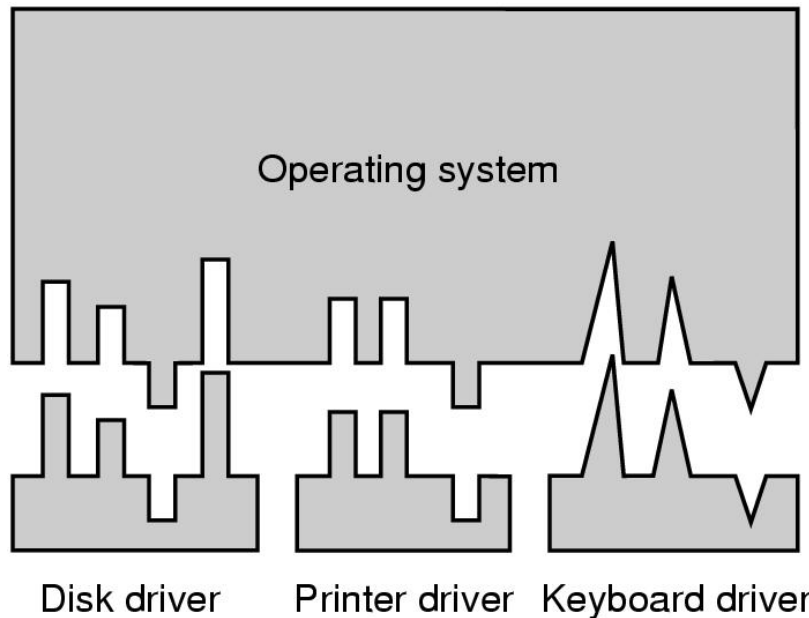

(a)

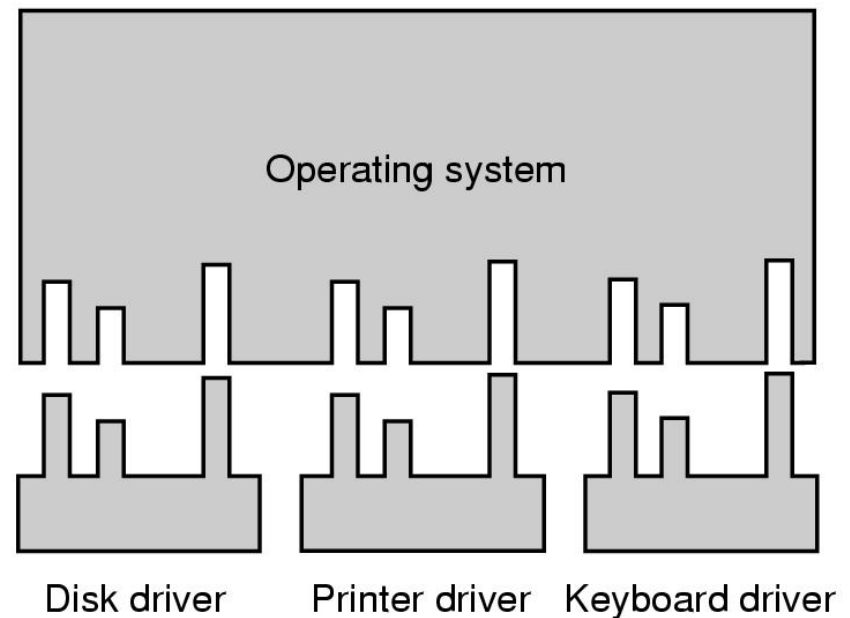

(b)

(a) Without a standard driver interface

(b) With a standard driver interface



Driver \Leftrightarrow Kernel Interface

- Major Issue is uniform interfaces to devices and kernel
 - Uniform device interface for kernel code
 - Allows different devices to be used the same way
 - No need to rewrite filesystem to switch between SCSI, IDE or RAM disk
 - Allows internal changes to device driver with fear of breaking kernel code
 - Uniform kernel interface for device code
 - Drivers use a defined interface to kernel services (e.g. kmalloc, install IRQ handler, etc.)
 - Allows kernel to evolve without breaking existing drivers
 - Together both uniform interfaces avoid a lot of programming implementing new interfaces



Device-Independent I/O Software

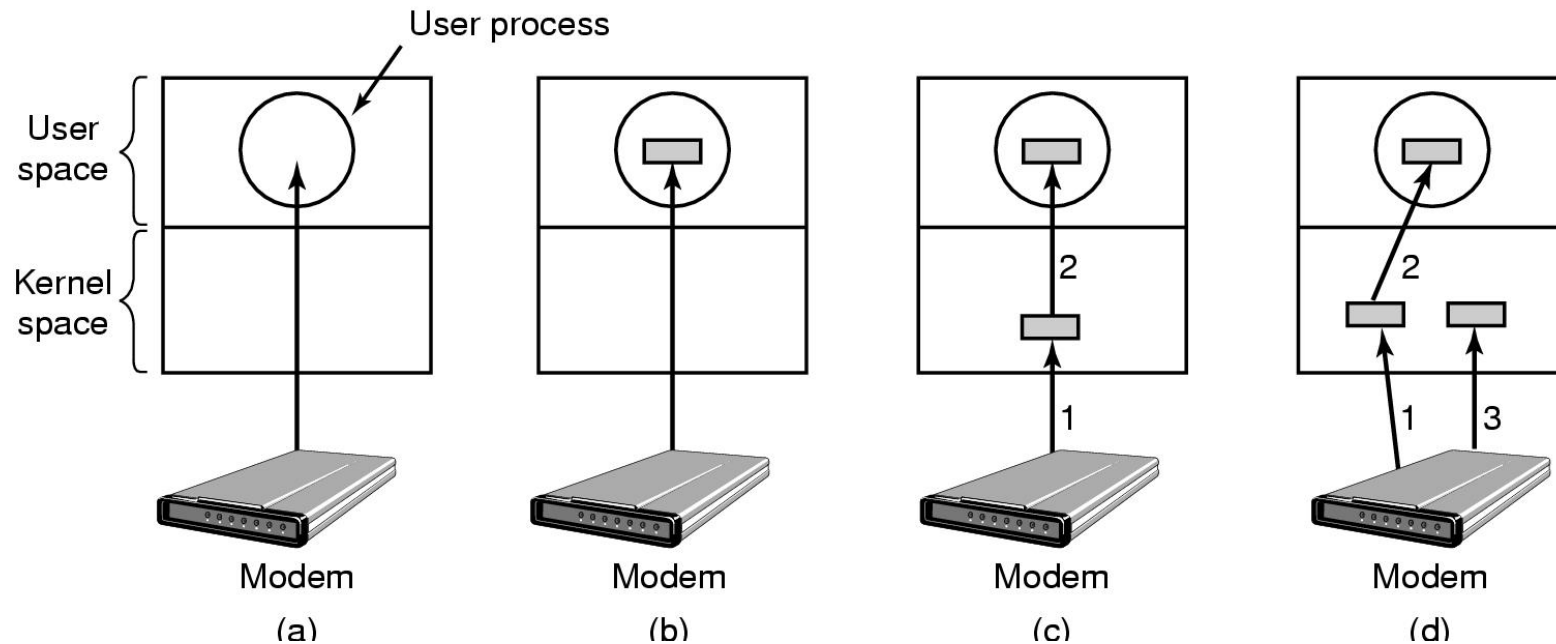

- (a) Unbuffered input
- (b) Buffering in user space
- (c) *Single buffering* in the kernel followed by copying to user space
- (d) Double buffering in the kernel



No Buffering

- Process must read/write a device a byte/word at a time
 - Each individual system call adds significant overhead
 - Process must wait until each I/O is complete
 - Blocking/interrupt/waking adds to overhead.
 - Many short runs of a process is inefficient (poor CPU cache temporal locality)



User-level Buffering

- Process specifies a memory *buffer* that incoming data is placed in until it fills
 - Filling can be done by interrupt service routine
 - Only a single system call, and block/wakeup per data buffer
 - Much more efficient

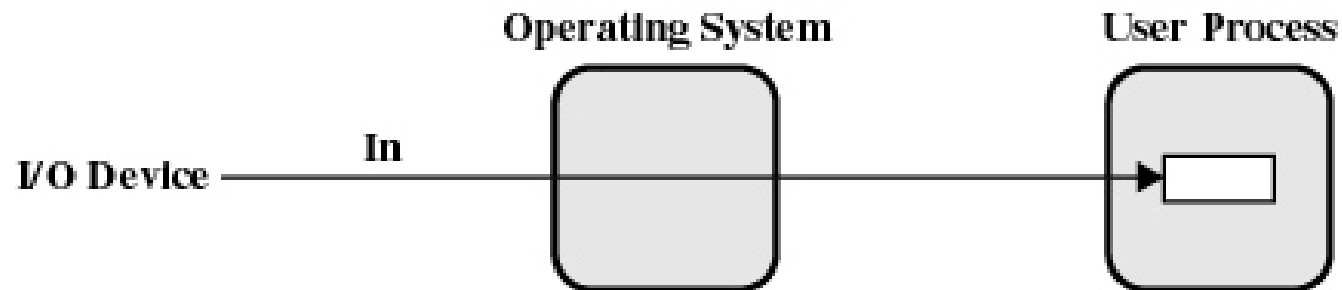

User-level Buffering

- Issues
 - What happens if buffer is paged out to disk
 - Could lose data while buffer is paged in
 - Could lock buffer in memory (needed for DMA), however many processes doing I/O reduce RAM available for paging. Can cause deadlock as RAM is limited resource
 - Consider write case
 - When is buffer available for re-use?
 - Either process must block until potential slow device drains buffer
 - or deal with asynchronous signals indicating buffer drained



Single Buffer

- Operating system assigns a buffer in main memory for an I/O request
- Stream-oriented
 - Used a line at time
 - User input from a terminal is one line at a time with carriage return signaling the end of the line
 - Output to the terminal is one line at a time



Single Buffer

- Block-oriented
 - Input transfers made to buffer
 - Block moved to user space when needed
 - Another block is moved into the buffer
 - Read ahead



Single Buffer

- User process can process one block of data while next block is read in
- Swapping can occur since input is taking place in system memory, not user memory
- Operating system keeps track of assignment of system buffers to user processes

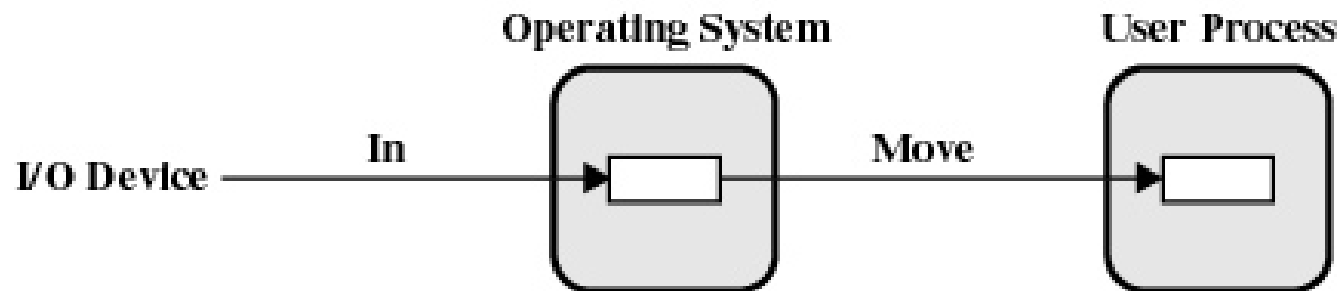

(b) Single buffering



Single Buffer Speed Up

- Assume
 - T is transfer time from device
 - C is computation time to process incoming packet
 - M is time to copy kernel buffer to user buffer
- Computation and transfer can be done in parallel
- Speed up with buffering

$$\frac{T + C}{\max(T, C) + M}$$



Single Buffer

- What happens if kernel buffer is full, the user buffer is swapped out, and more data is received???
 - We start to lose characters or drop network packets



Double Buffer

- Use two system buffers instead of one
- A process can transfer data to or from one buffer while the operating system empties or fills the other buffer

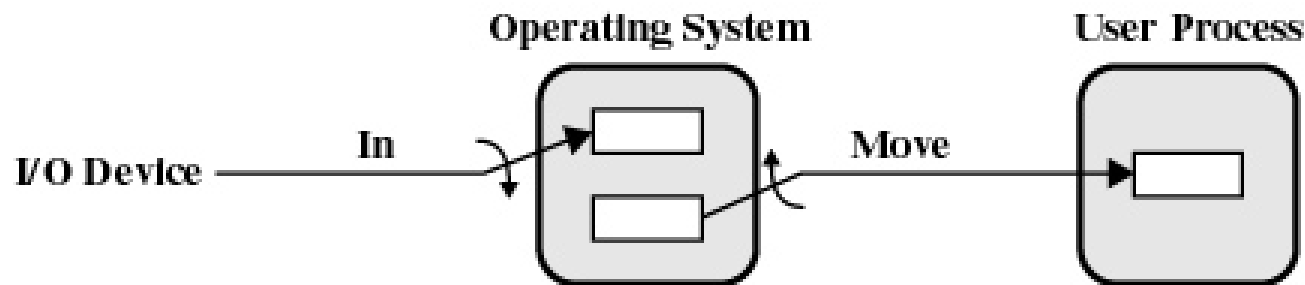

(c) Double buffering



Double Buffer Speed Up

- Computation and Memory copy can be done in parallel with transfer
- Speed up with double buffering

$$\frac{T + C}{\max(T, C + M)}$$

- Usually M is much less than T giving a favourable result



Double Buffer

- May be insufficient for really bursty traffic
 - Lots of application writes between long periods of computation
 - Long periods of application computation while receiving data
 - Might want to read-ahead more than a single block for disk



Circular Buffer

- More than two buffers are used
- Each individual buffer is one unit in a circular buffer
- Used when I/O operation must keep up with process



(d) Circular buffering

Important Note

- Notice that buffering, double buffering, and circular buffering are all

Bounded-Buffer Producer-Consumer Problems



Is Buffering Always Good?

$$\frac{T + C}{\max(T, C) + M} \quad \frac{T + C}{\max(T, C + M)}$$

Single Double

- Can M be similar or greater than C or T ?



Buffering in Fast Networks

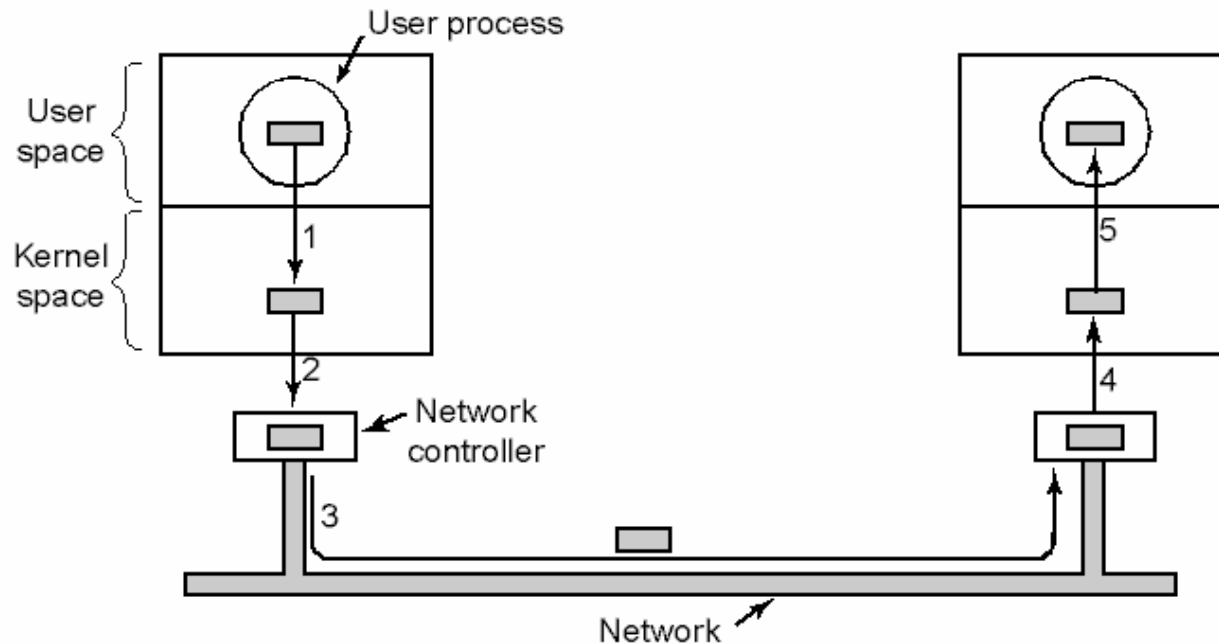

- Networking may involve many copies
- Copying reduces performance
 - Especially if copy costs are similar to or greater than computation or transfer costs
- Super-fast networks put significant effort into achieving zero-copy
- Buffering also increases latency



I/O Software Summary

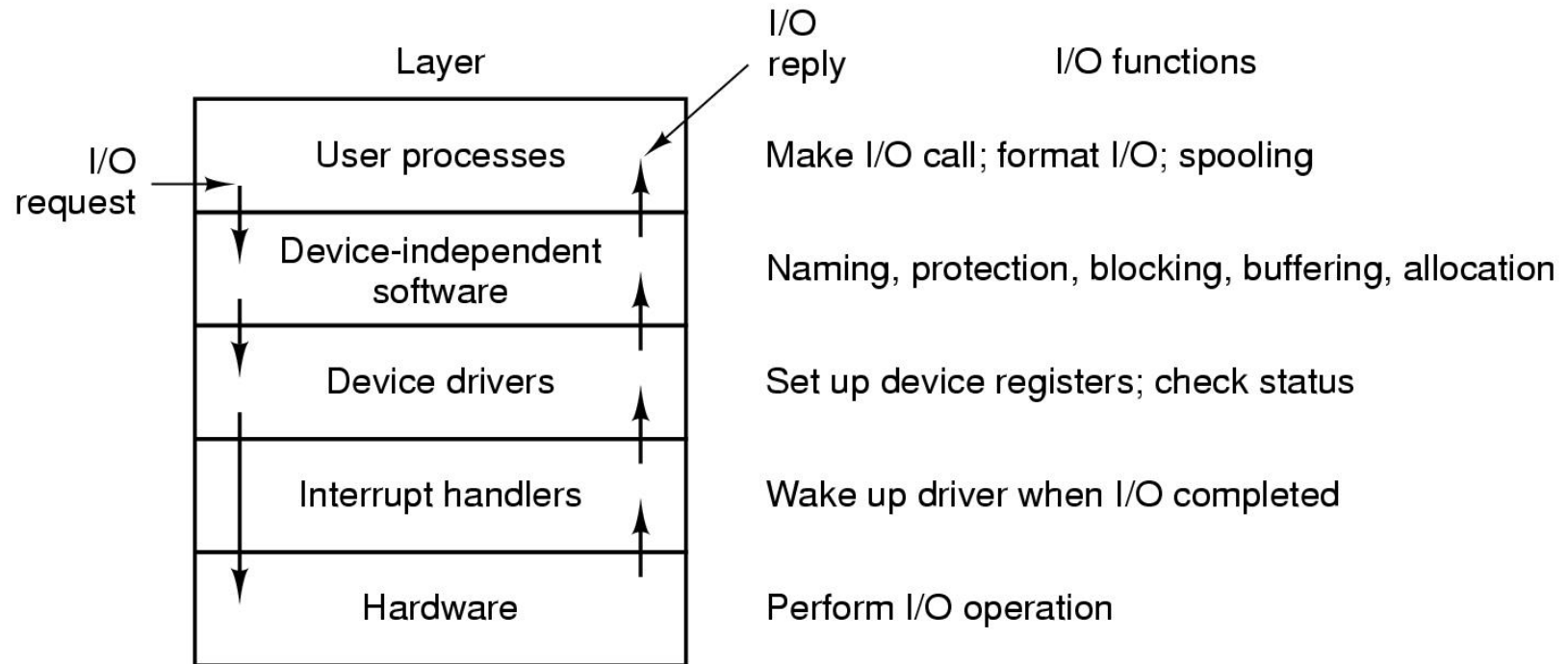

Layers of the I/O system and the main functions of each layer

